

# Project Specific Water Quality Management Plan

A Template for Projects located within the **Santa Ana Watershed** Region of Riverside County

**Project Title:** Perris at Pentecostal

**Development No:** PEN21-0214/0216

**Design Review/Case No:** LWQ21-0047

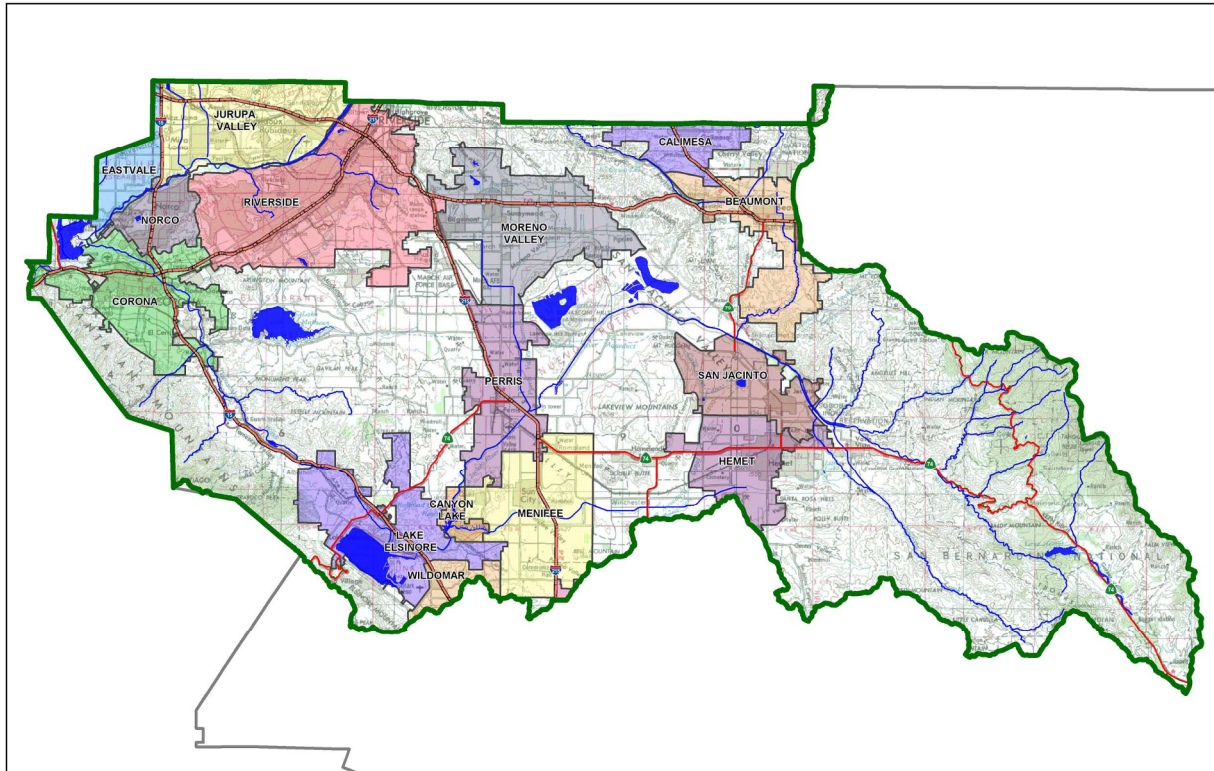

- Preliminary
- Final

**Original Date Prepared:** April 14, 2020

**Revision Date(s):**

- August 19, 2020
- August 17, 2021
- December 3, 2021

*Prepared for Compliance with  
Regional Board Order No. **R8-2010-0033***

**Template revised June 30, 2016**

**Contact Information:**

**Prepared for:**

Patton Development  
41 Corporate Park #250  
Irvine, CA 92606

**Prepared by:**

GreenbergFarrow  
30 Executive Park, Suite 100  
Irvine, CA 92614  
Bahareh Sehatzadeh, PE  
949.296.0450

## A Brief Introduction

This Project-Specific WQMP Template for the **Santa Ana Region** has been prepared to help guide you in documenting compliance for your project. Because this document has been designed to specifically document compliance, you will need to utilize the WQMP Guidance Document as your “how-to” manual to help guide you through this process. Both the Template and Guidance Document go hand-in-hand, and will help facilitate a well prepared Project-Specific WQMP. Below is a flowchart for the layout of this Template that will provide the steps required to document compliance.

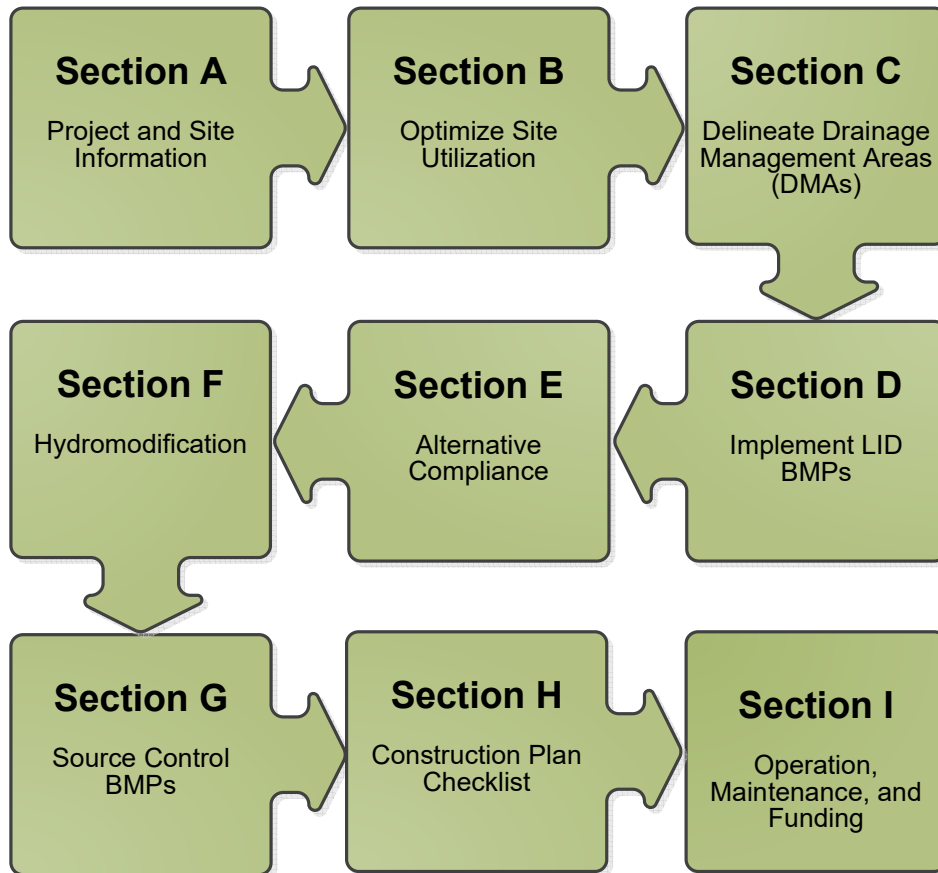



# OWNER'S CERTIFICATION

This Project-Specific Water Quality Management Plan (WQMP) has been prepared for Patton Development by GreenbergFarrow for the Perris at Pentecostal project.

This WQMP is intended to comply with the requirements of the City of Moreno Valley for Ordinance 827 which includes the requirement for the preparation and implementation of a Project-Specific WQMP.

The undersigned, while owning the property/project described in the preceding paragraph, shall be responsible for the implementation and funding of this WQMP and will ensure that this WQMP is amended as appropriate to reflect up-to-date conditions on the site. In addition, the property owner accepts responsibility for interim operation and maintenance of Stormwater BMPs until such time as this responsibility is formally transferred to a subsequent owner. This WQMP will be reviewed with the facility operator, facility supervisors, employees, tenants, maintenance and service contractors, or any other party (or parties) having responsibility for implementing portions of this WQMP. At least one copy of this WQMP will be maintained at the project site or project office in perpetuity. The undersigned is authorized to certify and to approve implementation of this WQMP. The undersigned is aware that implementation of this WQMP is enforceable under Moreno Valley Water Quality Ordinance 827 (Municipal Code Section 8.10, 8.21).

"I, the undersigned, certify under penalty of law that the provisions of this WQMP have been reviewed and accepted and that the WQMP will be transferred to future successors in interest."

Michael W Patton  
Owner's Signature

Michael Patton  
Owner's Printed Name

12-15-21  
Date

Managing Member  
Owner's Title/Position  
Perris at Pentecostal, LLC

# PREPARER'S CERTIFICATION

"The selection, sizing and design of stormwater treatment and other stormwater quality and quantity control measures in this plan meet the requirements of Regional Water Quality Control Board Order No. **R8-2010-0033** and any subsequent amendments thereto."

B. Sehat  
Preparer's Signature

Bahareh Sehatzadeh, PE  
Preparer's Printed Name

01/10/2022  
Date

Senior Project Manager  
Preparer's Title/Position

Preparer's Licensure:



## Table of Contents

Section A: Project and Site Information.....	6
A.1 Maps and Site Plans.....	7
A.2 Identify Receiving Waters.....	8
A.3 Additional Permits/Approvals required for the Project: .....	8
Section B: Optimize Site Utilization (LID Principles) .....	9
Section C: Delineate Drainage Management Areas (DMAs).....	11
Section D: Implement LID BMPs .....	13
D.1 Infiltration Applicability .....	13
D.2 Harvest and Use Assessment.....	14
D.3 Bioretention and Biotreatment Assessment .....	16
D.4 Feasibility Assessment Summaries .....	17
D.5 LID BMP Sizing .....	18
Section E: Alternative Compliance (LID Waiver Program) .....	20
E.1 Identify Pollutants of Concern .....	21
E.2 Stormwater Credits .....	22
E.3 Sizing Criteria.....	22
E.4 Treatment Control BMP Selection .....	23
Section F: Hydromodification .....	24
F.1 Hydrologic Conditions of Concern (HCOC) Analysis.....	24
F.2 HCOC Mitigation.....	25
Section G: Source Control BMPs.....	26
Section H: Construction Plan Checklist .....	30
Section I: Operation, Maintenance and Funding.....	31

## List of Tables

Table A.1 Identification of Receiving Waters.....	8
Table A.2 Other Applicable Permits.....	8
Table C.1 DMA Classifications.....	11
Table C.2 Type 'A', Self-Treating Areas.....	11
Table C.3 Type 'B', Self-Retaining Areas.....	11
Table C.4 Type 'C', Areas that Drain to Self-Retaining Areas.....	12
Table C.5 Type 'D', Areas Draining to BMPs.....	12
Table D.1 Infiltration Feasibility.....	13
Table D.2 LID Prioritization Summary Matrix.....	17
Table D.3 DCV Calculations for LID BMPs.....	18
Table D.4 DCV Calculations for LID BMPs.....	18
Table D.5 DCV Calculations for LID BMPs.....	19
Table D.6 DCV Calculations for LID BMPs.....	19
Table D.7 DCV Calculations for LID BMPs.....	19
Table E.1 Potential Pollutants by Land Use Type.....	21
Table E.2 Water Quality Credits.....	22
Table E.3 Treatment Control BMP Sizing.....	22
Table E.4 Treatment Control BMP Selection.....	23
Table F.1 Hydrologic Conditions of Concern Summary.....	24
Table G.1 Permanent and Operational Source Control Measures.....	26
Table H.1 Construction Plan Cross-reference.....	30

## List of Appendices

Appendix 1: Maps and Site Plans.....	32
Appendix 2: Construction Plans.....	33
Appendix 3: Soils Information.....	34
Appendix 4: Historical Site Conditions.....	35
Appendix 5: LID Infeasibility.....	36
Appendix 6: BMP Design Details.....	37
Appendix 7: Hydromodification.....	38
Appendix 8: Source Control.....	39
Appendix 9: O&M.....	40
Appendix 10: Educational Materials.....	41

## Section A: Project and Site Information

PROJECT INFORMATION	
Type of Project:	Residential
Planning Area:	
Community Name:	
Development Name:	Perris at Pentecostal
PROJECT LOCATION	
Latitude & Longitude (DMS): 33°53'24.68"N, 117°13'45.85"W	
Project Watershed and Sub-Watershed: Santa Ana River Watershed, San Jacinto Valley HU, Perris HA, Perris Valley HSA	
Gross Acres: 21.83	
APN(s): 485220006, 485220007, 485220008, 485220009, 485220015, 485220043, 485220044	
Map Book and Page No.: MB 49/45, MB 54/72-73	
PROJECT CHARACTERISTICS	
Proposed or Potential Land Use(s)	Residential
Proposed or Potential SIC Code(s)	None
Area of Impervious Project Footprint (SF)	770,996 SF
Total Area of <u>proposed</u> Impervious Surfaces within the Project Footprint (SF)/or Replacement	752,000 SF
Does the project consist of offsite road improvements?	<input checked="" type="checkbox"/> Y <input type="checkbox"/> N
Does the project propose to construct unpaved roads?	<input type="checkbox"/> Y <input checked="" type="checkbox"/> N
Is the project part of a larger common plan of development (phased project)?	<input type="checkbox"/> Y <input checked="" type="checkbox"/> N
EXISTING SITE CHARACTERISTICS	
Total area of <u>existing</u> Impervious Surfaces within the Project limits Footprint (SF)	46,000 SF
Is the project located within any MSHCP Criteria Cell?	<input type="checkbox"/> Y <input checked="" type="checkbox"/> N
If so, identify the Cell number:	N/A
Are there any natural hydrologic features on the project site?	<input type="checkbox"/> Y <input checked="" type="checkbox"/> N
Is a Geotechnical Report attached?	<input checked="" type="checkbox"/> Y <input type="checkbox"/> N
If no Geotech. Report, list the NRCS soils type(s) present on the site (A, B, C and/or D)	A
What is the Water Quality Design Storm Depth for the project?	0.65

The project is located across APNs 485220006, 485220007, 485220008, 485220009, 485220015, 485220043, and 485220044 at the northwest corner of Iris Avenue and Perris Boulevard as shown in Appendix A. The existing 20.4-acre site consists of residential tracts. It generally slopes from northwest to southeast at a gradient of approximately 0.8%. No existing underground storm drain facilities exist near the site that are tributary to the project. The site is bordered by Iris Avenue to the south, Perris Boulevard to the east, Emma Lane to the west, and Santiago Drive to the north. Iris Avenue and Perris Boulevard are existing improved streets. Emma Lane and Santiago Drive are existing dirt roads and are not yet improved.

The developed site will be an apartment complex with a clubhouse and open space. The site will be graded to generally follow the existing condition drainage patterns to minimize adverse effects to the current topography and minimize the use of import soil. Runoff for the onsite area and the southwest portion of Santiago Drive (Subarea 100) will flow through proposed underground storm drains which lead to the proposed detention basin located at the southeast corner of the site. Offsite runoff from Emma Lane (Subarea 200) will also be collected via storm drain and directed to the existing 24" RCP public storm drain

(Line “D-1A”) to the west of Emma Lane in Iris Avenue. Offsite runoff for the southeast portion of Santiago Drive (Subarea 300) will flow through gutters to the existing catch basin and storm drain (Lateral “M3-7”) at the southwest corner of Santiago and Perris Boulevard.

The basin and parkway drain will ensure the project detains up to the 100-year stormwater volume exceeding the pre-developed condition while restricting outflow up to the 100-year pre-developed flow rate for the proposed onsite development only. The basin will both detain and infiltrate the project’s onsite runoff as no underground storm drain facilities exist near the site.

The basin will operate as a hybrid: it will detain and infiltrate onsite flows for the storm events specified herein while also acting as an infiltration basin to treat the project’s runoff. While the hybrid basin will be deeper than 5’, it will act as an infiltration basin for only the first 2.8’ of runoff depth as determined by the BMP calculation sheets herein. The basin will only store runoff in excess of this in order to attenuate runoff to the predevelopment condition.

Offsite runoff for Emma will be treated by proposed infiltration trench BMPs located onsite, adjacent to the street right of way. Street runoff will be conveyed to these BMPs through parkway drains sized to treat the water quality volume only. Storm events exceeding this will flow past the infiltration trenches and continue into the proposed underground storm drain.

Infiltration trench BMPs will also be used for the south portions of Santiago west of the California Aqueduct. Parkway drains will also be used to direct runoff to the infiltration trench BMPs onsite. The parkway drain for the southeast portion of Santiago will be sized for water quality volume only, while the parkway drain for the southwest portion of Santiago will be sized for the 100-year storm event as this portion of the street is in a sump condition. Treatment is not feasible for the portion of the street that crosses the aqueduct, as the excavation required for BMPs would risk conflict with the aqueduct. See WQMP Site Plan for locations.

A parkway drain will also be used to convey some of the runoff from the basin to Iris Avenue while restricting flow volumes and flow rates to the predevelopment condition. This water will then flow through existing gutters in Iris Avenue and Perris Boulevard and enter the catch basins at the northwest corner of Perris Boulevard and Krameria Avenue. For storm events exceeding the capacity of the parkway drain, an emergency overflow weir structure will allow excess runoff to flow over the parkway drain and sidewalk into Iris Avenue. Please see the WQMP Site Plan for delineation.

## A.1 Maps and Site Plans

When completing your Project-Specific WQMP, include a map of the local vicinity and existing site. In addition, include all grading, drainage, landscape/plant palette and other pertinent construction plans in Appendix 2. At a **minimum**, your WQMP Site Plan should include the following:

- Drainage Management Areas
- Proposed Structural BMPs
- Drainage Path
- Drainage Infrastructure, Inlets, Overflows
- Source Control BMPs
- Buildings, Roof Lines, Downspouts
- Impervious Surfaces
- Standard Labeling
- BMP Locations (Lat/Long)



Use your discretion on whether or not you may need to create multiple sheets or can appropriately accommodate these features on one or two sheets. Keep in mind that the Co-Permittee plan reviewer must be able to easily analyze your project utilizing this template and its associated site plans and maps.

## A.2 Identify Receiving Waters

Using Table A.1 below, list in order of upstream to downstream, the receiving waters that the project site is tributary to. Continue to fill each row with the Receiving Water's 303(d) listed impairments (if any), designated beneficial uses, and proximity, if any, to a RARE beneficial use. Include a map of the receiving waters in Appendix 1.

**Table A.1 Identification of Receiving Waters**

Receiving Waters	EPA Approved 303(d) List Impairments	Designated Beneficial Uses	Proximity to RARE Beneficial Use
Perris North	None	NONE	N/A
San Jacinto River Reach 3	None	AGR, GWR, MUN, REC1, REC2, WARM, WILD	N/A
San Jacinto River Reach 2 / Canyon Lake (Railroad Canyon Reservoir)	Nutrients	AGR, GWR, WILD, MUN, REC1, REC2, WARM	N/A
San Jacinto River Reach 1	None	AGR, GWR, MUN, REC1, REC2, WARM, WILD	N/A
Lake Elsinore	DDT, Nutrients, Organic Enrichment/Low Dissolved Oxygen, PCBs, Toxicity	MUN, REC1, REC2, WARM, WILD	N/A

## A.3 Additional Permits/Approvals required for the Project:

**Table A.2 Other Applicable Permits**

Agency	Permit Required	
State Department of Fish and Game, 1602 Streambed Alteration Agreement	<input type="checkbox"/> Y	<input checked="" type="checkbox"/> N
State Water Resources Control Board, Clean Water Act (CWA) Section 401 Water Quality Cert.	<input type="checkbox"/> Y	<input checked="" type="checkbox"/> N
US Army Corps of Engineers, CWA Section 404 Permit	<input type="checkbox"/> Y	<input checked="" type="checkbox"/> N
US Fish and Wildlife, Endangered Species Act Section 7 Biological Opinion	<input type="checkbox"/> Y	<input checked="" type="checkbox"/> N
Statewide Construction General Permit Coverage	<input checked="" type="checkbox"/> Y	<input type="checkbox"/> N
Statewide Industrial General Permit Coverage	<input type="checkbox"/> Y	<input checked="" type="checkbox"/> N
Western Riverside MSHCP Consistency Approval (e.g., JPR, DBESP)	<input type="checkbox"/> Y	<input checked="" type="checkbox"/> N
Other (please list in the space below as required) Grading & Building	<input checked="" type="checkbox"/> Y	<input type="checkbox"/> N

If yes is answered to any of the questions above, the Co-Permittee may require proof of approval/coverage from those agencies as applicable including documentation of any associated requirements that may affect this Project-Specific WQMP.

## Section B: Optimize Site Utilization (LID Principles)

Review of the information collected in Section 'A' will aid in identifying the principal constraints on site design and selection of LID BMPs as well as opportunities to reduce imperviousness and incorporate LID Principles into the site and landscape design. For example, **constraints** might include impermeable soils, high groundwater, groundwater pollution or contaminated soils, steep slopes, geotechnical instability, high-intensity land use, heavy pedestrian or vehicular traffic, utility locations or safety concerns. **Opportunities** might include existing natural areas, low areas, oddly configured or otherwise unbuildable parcels, easements and landscape amenities including open space and buffers (which can double as locations for bioretention BMPs), and differences in elevation (which can provide hydraulic head). Prepare a brief narrative for each of the site optimization strategies described below. This narrative will help you as you proceed with your LID design and explain your design decisions to others.

The 2010 Santa Ana MS4 Permit further requires that LID Retention BMPs (Infiltration Only or Harvest and Use) be used unless it can be shown that those BMPs are infeasible. Therefore, it is important that your narrative identify and justify if there are any constraints that would prevent the use of those categories of LID BMPs. Similarly, you should also note opportunities that exist which will be utilized during project design. Upon completion of identifying Constraints and Opportunities, include these on your WQMP Site plan in Appendix 1.

Consideration of "highest and best use" of the discharge should also be considered. For example, Lake Elsinore is evaporating faster than runoff from natural precipitation can recharge it. Requiring infiltration of 85% of runoff events for projects tributary to Lake Elsinore would only exacerbate current water quality problems associated with Pollutant concentration due to lake water evaporation. In cases where rainfall events have low potential to recharge Lake Elsinore (i.e. no hydraulic connection between groundwater to Lake Elsinore, or other factors), requiring infiltration of Urban Runoff from projects is counterproductive to the overall watershed goals. Project proponents, in these cases, would be allowed to discharge Urban Runoff, provided they used equally effective filtration-based BMPs.

### Site Optimization

The following questions are based upon Section 3.2 of the WQMP Guidance Document. Review of the WQMP Guidance Document will help you determine how best to optimize your site and subsequently identify opportunities and/or constraints, and document compliance.

Did you identify and preserve existing drainage patterns? If so, how? If not, why?

*Yes. The existing topography generally flows to the southeast corner of the project boundary. The proposed grading follows this drainage pattern to gather stormwater in a basin at the southeast corner of the site.*

Did you identify and protect existing vegetation? If so, how? If not, why?

*No. The existing site is vacant with grasses, weeds, brush, and some barren areas with exposed gravelly soils. The majority of the project area will be disturbed during construction and existing vegetation will be removed. The proposed development will construct landscape areas with drought-tolerant vegetation.*

Did you identify and preserve natural infiltration capacity? If so, how? If not, why?

*Yes. The site's natural infiltration capacity is being utilized in the proposed water quality basin as the primary treatment measure.*

Did you identify and minimize impervious area? If so, how? If not, why?

*Yes. Open space is provided around the club house and at the northwest of the site. Pervious areas are also provided around the residences, in landscape islands, and at the water quality basin.*

Did you identify and disperse runoff to adjacent pervious areas? If so, how? If not, why?

*Yes. Runoff from impervious surfaces has been directed to the onsite storm drains, which outlet to the onsite basin for infiltration.*

# Section C: Delineate Drainage Management Areas (DMAs)

Utilizing the procedure in Section 3.3 of the WQMP Guidance Document which discusses the methods of delineating and mapping your project site into individual DMAs, complete Table C.1 below to appropriately categorize the types of classification (e.g., Type A, Type B, etc.) per DMA for your project site. Upon completion of this table, this information will then be used to populate and tabulate the corresponding tables for their respective DMA classifications.

**Table C.1 DMA Classifications**

DMA Name or ID	Surface Type(s) <sup>12</sup>	Area (Sq. Ft.)	DMA Type
DMA-1 Residential	Mixed Surface Types	485,995	D
DMA-2 Open Space	Ornamental Landscaping	120,729	D
DMA-3 Street	Concrete or Asphalt	281,924	D
DMA-4 Santiago	Mixed Surface Types	11,292	D
DMA-5 Emma North	Mixed Surface Types	43,530	D
DMA-6 Emma South	Mixed Surface Types	28,678	D
DMA-7 Emma Entry	Mixed Surface Types	4,113	D
DMA-8 Santiago Southeast	Mixed Surface Types	26,250	D
DMA-9 Santiago Easement	Mixed Surface Types	10,230	D

<sup>1</sup>Reference Table 2-1 in the WQMP Guidance Document to populate this column

<sup>2</sup>If multi-surface provide back-up

**Table C.2 Type 'A', Self-Treating Areas**

DMA Name or ID	Area (Sq. Ft.)	Stabilization Type	Irrigation Type (if any)

**Table C.3 Type 'B', Self-Retaining Areas**

Self-Retaining Area				Type 'C' DMAs that are draining to the Self-Retaining Area		
DMA Name/ ID	Post-project surface type	Area (square feet)	Storm Depth (inches)	DMA Name / ID	[C] from Table C.4 = [C]	Required Retention Depth (inches)
		[A]	[B]			[D]

$$[D] = [B] + \frac{[B] \cdot [C]}{[A]}$$

**Table C.4 Type 'C', Areas that Drain to Self-Retaining Areas**

DMA					Receiving Self-Retaining DMA		
DMA Name/ ID	Area (square feet)	Post-project surface type	Impervious fraction	Product	DMA name /ID	Area (square feet)	Ratio
	[A]		[B]			[C] = [A] x [B]	[D]

**Table C.5 Type 'D', Areas Draining to BMPs**

DMA Name or ID	BMP Name or ID
DMA-1 Residential	Infiltration Basin
DMA-2 Open Space	Infiltration Basin
DMA-3 Street	Infiltration Basin
DMA-4 Santiago	DMA-4 Infiltration Trench
DMA-5 Emma North	DMA-5 Infiltration Trench
DMA-6 Emma South	DMA-6 Infiltration Trench
DMA-7 Emma Entry	None – See note below
DMA-8 Santiago Southeast	DMA-8 Infiltration Trench
DMA-9 Santiago Easement	None – See note below

*Note: More than one drainage management area can drain to a single LID BMP, however, one drainage management area may not drain to more than one BMP.*

**Note:** Offsite DMA-7 and DMA-9 are not tributary to BMPs because they do not account for a significant amount of the overall site’s impervious area, where significance is defined as 5% or more.



## Section D: Implement LID BMPs

### D.1 Infiltration Applicability

Is there an approved downstream ‘Highest and Best Use’ for stormwater runoff (see discussion in Chapter 2.4.4 of the WQMP Guidance Document for further details)?  Y  N

If yes has been checked, Infiltration BMPs shall not be used for the site; proceed to section D.3

If no, continue working through this section to implement your LID BMPs. It is recommended that you contact your Co-Permittee to verify whether or not your project discharges to an approved downstream ‘Highest and Best Use’ feature.

### Geotechnical Report

A Geotechnical Report or Phase I Environmental Site Assessment may be required by the Copermitee to confirm present and past site characteristics that may affect the use of Infiltration BMPs. In addition, the Co-Permittee, at their discretion, may not require a geotechnical report for small projects as described in Chapter 2 of the WQMP Guidance Document. If a geotechnical report has been prepared, include it in Appendix 3. In addition, if a Phase I Environmental Site Assessment has been prepared, include it in Appendix 4.

Is this project classified as a small project consistent with the requirements of Chapter 2 of the WQMP Guidance Document?  Y  N

### Infiltration Feasibility

Table D.1 below is meant to provide a simple means of assessing which DMAs on your site support Infiltration BMPs and is discussed in the WQMP Guidance Document in Chapter 2.4.5. Check the appropriate box for each question and then list affected DMAs as applicable. If additional space is needed, add a row below the corresponding answer.

Table D.1 Infiltration Feasibility

Does the project site...	YES	NO
...have any DMAs with a seasonal high groundwater mark shallower than 10 feet? If Yes, list affected DMAs:		X
...have any DMAs located within 100 feet of a water supply well? If Yes, list affected DMAs:		X
...have any areas identified by the geotechnical report as posing a public safety risk where infiltration of stormwater could have a negative impact? If Yes, list affected DMAs:		X
...have measured in-situ infiltration rates of less than 1.6 inches / hour? If Yes, list affected DMAs:		X
...have significant cut and/or fill conditions that would preclude in-situ testing of infiltration rates at the final infiltration surface? If Yes, list affected DMAs:		X
...geotechnical report identify other site-specific factors that would preclude effective and safe infiltration? Describe here:		X

If you answered “Yes” to any of the questions above for any DMA, Infiltration BMPs should not be used for those DMAs and you should proceed to the assessment for Harvest and Use below.

## D.2 Harvest and Use Assessment

Please check what applies:

- Reclaimed water will be used for the non-potable water demands for the project.
- Downstream water rights may be impacted by Harvest and Use as approved by the Regional Board (verify with the Copermittee).
- The Design Capture Volume will be addressed using Infiltration Only BMPs. In such a case, Harvest and Use BMPs are still encouraged, but it would not be required if the Design Capture Volume will be infiltrated or evapotranspired.

If any of the above boxes have been checked, Harvest and Use BMPs need not be assessed for the site. If none of the above criteria applies, follow the steps below to assess the feasibility of irrigation use, toilet use and other non-potable uses (e.g., industrial use).

### Irrigation Use Feasibility

Complete the following steps to determine the feasibility of harvesting stormwater runoff for Irrigation Use BMPs on your site:

Step 1: Identify the total area of irrigated landscape on the site, and the type of landscaping used.

*Total Area of Irrigated Landscape:*

*Type of Landscaping (Conservation Design or Active Turf):*

Step 2: Identify the planned total of all impervious areas on the proposed project from which runoff might be feasibly captured and stored for irrigation use. Depending on the configuration of buildings and other impervious areas on the site, you may consider the site as a whole, or parts of the site, to evaluate reasonable scenarios for capturing and storing runoff and directing the stored runoff to the potential use(s) identified in Step 1 above.

*Total Area of Impervious Surfaces:*

Step 3: Cross reference the Design Storm depth for the project site (see Exhibit A of the WQMP Guidance Document) with the left column of Table 2-3 in Chapter 2 to determine the minimum area of Effective Irrigated Area per Tributary Impervious Area (EIATIA).

*Enter your EIATIA factor:*

Step 4: Multiply the unit value obtained from Step 3 by the total of impervious areas from Step 2 to develop the minimum irrigated area that would be required.

*Minimum required irrigated area:*

Step 5: Determine if harvesting stormwater runoff for irrigation use is feasible for the project by comparing the total area of irrigated landscape (Step 1) to the minimum required irrigated area (Step 4).

Minimum required irrigated area (Step 4)	Available Irrigated Landscape (Step 1)

## Toilet Use Feasibility

Complete the following steps to determine the feasibility of harvesting stormwater runoff for toilet flushing uses on your site:

Step 1: Identify the projected total number of daily toilet users during the wet season, and account for any periodic shut downs or other lapses in occupancy:

*Projected Number of Daily Toilet Users:*

*Project Type:*

Step 2: Identify the planned total of all impervious areas on the proposed project from which runoff might be feasibly captured and stored for toilet use. Depending on the configuration of buildings and other impervious areas on the site, you may consider the site as a whole, or parts of the site, to evaluate reasonable scenarios for capturing and storing runoff and directing the stored runoff to the potential use(s) identified in Step 1 above.

*Total Area of Impervious Surfaces:*

Step 3: Enter the Design Storm depth for the project site (see Exhibit A) into the left column of Table 2-2 in Chapter 2 to determine the minimum number of toilet users per tributary impervious acre (TUTIA).

*Enter your TUTIA factor:*

Step 4: Multiply the unit value obtained from Step 3 by the total of impervious areas from Step 2 to develop the minimum number of toilet users that would be required.

*Minimum number of toilet users:*

Step 5: Determine if harvesting stormwater runoff for toilet flushing use is feasible for the project by comparing the Number of Daily Toilet Users (Step 1) to the minimum required number of toilet users (Step 4).

**Minimum required Toilet Users (Step 4)**

**Projected number of toilet users (Step 1)**

## Other Non-Potable Use Feasibility

Are there other non-potable uses for stormwater runoff on the site (e.g. industrial use)? See Chapter 2 of the Guidance for further information. If yes, describe below. If no, write N/A.

N/A

Step 1: Identify the projected average daily non-potable demand, in gallons per day, during the wet season and accounting for any periodic shut downs or other lapses in occupancy or operation.

*Average Daily Demand:*

Step 2: Identify the planned total of all impervious areas on the proposed project from which runoff might be feasibly captured and stored for the identified non-potable use. Depending on the configuration of buildings and other impervious areas on the site, you may consider the site as a whole, or parts of the site, to evaluate reasonable scenarios for capturing and storing runoff and directing the stored runoff to the potential use(s) identified in Step 1 above.

*Total Area of Impervious Surfaces:*

Step 3: Enter the Design Storm depth for the project site (see Exhibit A) into the left column of Table 2-4 in Chapter 2 to determine the minimum demand for non-potable uses per tributary impervious acre.

*Enter the factor from Table 2-4:*

Step 4: Multiply the unit value obtained from Step 3 by the total of impervious areas from Step 2 to develop the minimum number of gallons per day of non-potable use that would be required.

*Minimum required use:*

Step 5: Determine if harvesting stormwater runoff for other non-potable use is feasible for the project by comparing the projected average daily use (Step 1) to the minimum required non-potable use (Step 4).

<b>Minimum required non-potable use (Step 4)</b>	<b>Projected average daily use (Step 1)</b>

If Irrigation, Toilet and Other Use feasibility anticipated demands are less than the applicable minimum values, Harvest and Use BMPs are not required and you should proceed to utilize LID Bioretention and Biotreatment per Section 3.4.2 of the WQMP Guidance Document.

### **D.3 Bioretention and Biotreatment Assessment**

Other LID Bioretention and Biotreatment BMPs as described in Chapter 2.4.7 of the WQMP Guidance Document are feasible on nearly all development sites with sufficient advance planning.

*Select one of the following:*

- LID Bioretention/Biotreatment BMPs will be used for some or all DMAs of the project as noted below in Section D.4 (note the requirements of Section 3.4.2 in the WQMP Guidance Document).
- A site-specific analysis demonstrating the technical infeasibility of all LID BMPs has been performed and is included in Appendix 5. If you plan to submit an analysis demonstrating the technical infeasibility of LID BMPs, request a pre-submittal meeting with the Copermittee to discuss this option. Proceed to Section E to document your alternative compliance measures.

## D.4 Feasibility Assessment Summaries

From the Infiltration, Harvest and Use, Bioretention and Biotreatment Sections above, complete Table D.2 below to summarize which LID BMPs are technically feasible, and which are not, based upon the established hierarchy.

Table D.2 LID Prioritization Summary Matrix

DMA Name/ID	LID BMP Hierarchy				No LID (Alternative Compliance)
	1. Infiltration	2. Harvest and use	3. Bioretention	4. Biotreatment	
DMA-1 Residential	<input checked="" type="checkbox"/>	<input type="checkbox"/>	<input type="checkbox"/>	<input type="checkbox"/>	<input type="checkbox"/>
DMA-2 Open Space	<input checked="" type="checkbox"/>	<input type="checkbox"/>	<input type="checkbox"/>	<input type="checkbox"/>	<input type="checkbox"/>
DMA-3 Street	<input checked="" type="checkbox"/>	<input type="checkbox"/>	<input type="checkbox"/>	<input type="checkbox"/>	<input type="checkbox"/>
DMA-4 Santiago	<input checked="" type="checkbox"/>	<input type="checkbox"/>	<input type="checkbox"/>	<input type="checkbox"/>	<input type="checkbox"/>
DMA-5 Emma North	<input checked="" type="checkbox"/>	<input type="checkbox"/>	<input type="checkbox"/>	<input type="checkbox"/>	<input type="checkbox"/>
DMA-6 Emma South	<input checked="" type="checkbox"/>	<input type="checkbox"/>	<input type="checkbox"/>	<input type="checkbox"/>	<input type="checkbox"/>
DMA-8 Emma South	<input checked="" type="checkbox"/>	<input type="checkbox"/>	<input type="checkbox"/>	<input type="checkbox"/>	<input type="checkbox"/>

For those DMAs where LID BMPs are not feasible, provide a brief narrative below summarizing why they are not feasible, include your technical infeasibility criteria in Appendix 5, and proceed to Section E below to document Alternative Compliance measures for those DMAs. Recall that each proposed DMA must pass through the LID BMP hierarchy before alternative compliance measures may be considered.

LID BMPs will be use used for all DMAs.



## D.5 LID BMP Sizing

Each LID BMP must be designed to ensure that the Design Capture Volume will be addressed by the selected BMPs. First, calculate the Design Capture Volume for each LID BMP using the  $V_{BMP}$  worksheet in Appendix F of the LID BMP Design Handbook. Second, design the LID BMP to meet the required  $V_{BMP}$  using a method approved by the Copermittee. Utilize the worksheets found in the LID BMP Design Handbook or consult with your Copermittee to assist you in correctly sizing your LID BMPs. Complete Table D.3 below to document the Design Capture Volume and the Proposed Volume for each LID BMP. Provide the completed design procedure sheets for each LID BMP in Appendix 6. You may add additional rows to the table below as needed.

Table D.3 DCV Calculations for LID BMPs

DMA Type/ID	DMA Area (square feet)	Post-Project Surface Type	Effective Impervious Fraction, $I_f$	DMA Runoff Factor	DMA Areas $\times$ Runoff Factor	Infiltration Basin		
						Design Storm Depth (in)	Design Capture Volume, $V_{BMP}$ (cubic feet)	Proposed Volume on Plans (cubic feet)
	[A]		[B]	[C]	[A] $\times$ [C]			
<b>DMA-1 Residential</b>	485995	Mixed Surface Types	0.82	0.62	302911.8			
<b>DMA-2 Open Space</b>	120729	Ornamental Landscaping	0.1	.11	13335.5			
<b>DMA-3 Street</b>	281924	Concrete or Asphalt	1	.89	251476.2			
	888648				567723.5	0.65	30751.7	54890

[B], [C] is obtained as described in Section 2.3.1 of the WQMP Guidance Document

[E] is obtained from Exhibit A in the WQMP Guidance Document

[G] is obtained from a design procedure sheet, such as in LID BMP Design Handbook and placed in Appendix 6

Table D.4 DCV Calculations for LID BMPs

DMA Type/ID	DMA Area (square feet)	Post-Project Surface Type	Effective Impervious Fraction, $I_f$	DMA Runoff Factor	DMA Areas $\times$ Runoff Factor	DMA-4 Infiltration Trench		
						Design Storm Depth (in)	Design Capture Volume, $V_{BMP}$ (cubic feet)	Proposed Volume on Plans (cubic feet)
	[A]		[B]	[C]	[A] $\times$ [C]			
<b>DMA-4 Santiago</b>	11292	Mixed Surface Types	0.88	0.70	7294.6			
	11292				7294.6	0.65	429.2	432

[B], [C] is obtained as described in Section 2.3.1 of the WQMP Guidance Document

[E] is obtained from Exhibit A in the WQMP Guidance Document

[G] is obtained from a design procedure sheet, such as in LID BMP Design Handbook and placed in Appendix 6

**Table D.5 DCV Calculations for LID BMPs**

DMA Type/ID	DMA Area (square feet)	Post-Project Surface Type	Effective Impervious Fraction, $I_f$	DMA Runoff Factor	DMA Areas $\times$ Runoff Factor	<i>DMA-5 Infiltration Trench</i>		
	[A]				[C]			
<b>DMA-5 Emma North</b>	43530	Mixed Surface Types	0.9	0.73	31789.2	Design Storm Depth (in)	Design Capture Volume, $V_{BMP}$ (cubic feet)	Proposed Volume on Plans (cubic feet)
	43530				31789.2	0.65	1721.9	1728

[B], [C] is obtained as described in Section 2.3.1 of the WQMP Guidance Document

[E] is obtained from Exhibit A in the WQMP Guidance Document

[G] is obtained from a design procedure sheet, such as in LID BMP Design Handbook and placed in Appendix 6

**Table D.6 DCV Calculations for LID BMPs**

DMA Type/ID	DMA Area (square feet)	Post-Project Surface Type	Effective Impervious Fraction, $I_f$	DMA Runoff Factor	DMA Areas $\times$ Runoff Factor	<i>DMA-6 Infiltration Trench</i>		
	[A]				[C]			
<b>DMA-6 Emma South</b>	28678	Mixed Surface Types	0.92	0.76	21795.3	Design Storm Depth (in)	Design Capture Volume, $V_{BMP}$ (cubic feet)	Proposed Volume on Plans (cubic feet)
	28679				21795.3	0.65	1180.6	1224

[B], [C] is obtained as described in Section 2.3.1 of the WQMP Guidance Document

[E] is obtained from Exhibit A in the WQMP Guidance Document

[G] is obtained from a design procedure sheet, such as in LID BMP Design Handbook and placed in Appendix 6

**Table D.7 DCV Calculations for LID BMPs**

DMA Type/ID	DMA Area (square feet)	Post-Project Surface Type	Effective Impervious Fraction, $I_f$	DMA Runoff Factor	DMA Areas $\times$ Runoff Factor	<i>DMA-8 Infiltration Trench</i>		
	[A]				[C]			
<b>DMA-8 Pavement</b>	14401	Concrete or Asphalt	1	0.89	12845.7	Design Storm Depth (in)	Design Capture Volume, $V_{BMP}$ (cubic feet)	Proposed Volume on Plans (cubic feet)
<b>DMA-8 LS</b>	2110	Ornamental Landscaping	0.1	0.11	233.1			
	16511				13078.8	0.65	708.4	720

[B], [C] is obtained as described in Section 2.3.1 of the WQMP Guidance Document

[E] is obtained from Exhibit A in the WQMP Guidance Document

[G] is obtained from a design procedure sheet, such as in LID BMP Design Handbook and placed in Appendix 6

## Section E: Alternative Compliance (LID Waiver Program)

LID BMPs are expected to be feasible on virtually all projects. Where LID BMPs have been demonstrated to be infeasible as documented in Section D, other Treatment Control BMPs must be used (subject to LID waiver approval by the Copermittee). Check one of the following Boxes:

LID Principles and LID BMPs have been incorporated into the site design to fully address all Drainage Management Areas. No alternative compliance measures are required for this project and thus this Section is not required to be completed.

- Or -

The following Drainage Management Areas are unable to be addressed using LID BMPs. A site-specific analysis demonstrating technical infeasibility of LID BMPs has been approved by the Co-Permittee and included in Appendix 5. Additionally, no downstream regional and/or sub-regional LID BMPs exist or are available for use by the project. The following alternative compliance measures on the following pages are being implemented to ensure that any pollutant loads expected to be discharged by not incorporating LID BMPs, are fully mitigated.

## E.1 Identify Pollutants of Concern

Utilizing Table A.1 from Section A above which noted your project's receiving waters and their associated EPA approved 303(d) listed impairments, cross reference this information with that of your selected Priority Development Project Category in Table E.1 below. If the identified General Pollutant Categories are the same as those listed for your receiving waters, then these will be your Pollutants of Concern and the appropriate box or boxes will be checked on the last row. The purpose of this is to document compliance and to help you appropriately plan for mitigating your Pollutants of Concern in lieu of implementing LID BMPs.

Table E.1 Potential Pollutants by Land Use Type

Priority Development Project Categories and/or Project Features (check those that apply)	General Pollutant Categories							
	Bacterial Indicators	Metals	Nutrients	Pesticides	Toxic Organic Compounds	Sediments	Trash & Debris	Oil & Grease
<input type="checkbox"/> Detached Residential Development	P	N	P	P	N	P	P	P
<input type="checkbox"/> Attached Residential Development	P	N	P	P	N	P	P	P <sup>(2)</sup>
<input type="checkbox"/> Commercial/Industrial Development	P <sup>(3)</sup>	P	P <sup>(1)</sup>	P <sup>(1)</sup>	P <sup>(5)</sup>	P <sup>(1)</sup>	P	P
<input type="checkbox"/> Automotive Repair Shops	N	P	N	N	P <sup>(4, 5)</sup>	N	P	P
<input type="checkbox"/> Restaurants (>5,000 ft <sup>2</sup> )	P	N	N	N	N	N	P	P
<input type="checkbox"/> Hillside Development (>5,000 ft <sup>2</sup> )	P	N	P	P	N	P	P	P
<input type="checkbox"/> Parking Lots (>5,000 ft <sup>2</sup> )	P <sup>(6)</sup>	P	P <sup>(1)</sup>	P <sup>(1)</sup>	P <sup>(4)</sup>	P <sup>(1)</sup>	P	P
<input type="checkbox"/> Retail Gasoline Outlets	N	P	N	N	P	N	P	P
<b>Project Priority Pollutant(s) of Concern</b>	<input type="checkbox"/>	<input type="checkbox"/>	<input type="checkbox"/>	<input type="checkbox"/>	<input type="checkbox"/>	<input type="checkbox"/>	<input type="checkbox"/>	<input type="checkbox"/>

P = Potential

N = Not Potential

<sup>(1)</sup> A potential Pollutant if non-native landscaping exists or is proposed onsite; otherwise not expected

<sup>(2)</sup> A potential Pollutant if the project includes uncovered parking areas; otherwise not expected

<sup>(3)</sup> A potential Pollutant is land use involving animal waste

<sup>(4)</sup> Specifically petroleum hydrocarbons

<sup>(5)</sup> Specifically solvents

<sup>(6)</sup> Bacterial indicators are routinely detected in pavement runoff

## E.2 Stormwater Credits

Projects that cannot implement LID BMPs but nevertheless implement smart growth principles are potentially eligible for Stormwater Credits. Utilize Table 3-8 within the WQMP Guidance Document to identify your Project Category and its associated Water Quality Credit. If not applicable, write N/A.

Table E.2 Water Quality Credits

Qualifying Project Categories	Credit Percentage <sup>2</sup>
N/A	
Total Credit Percentage <sup>1</sup>	

<sup>1</sup>Cannot Exceed 50%

<sup>2</sup>Obtain corresponding data from Table 3-8 in the WQMP Guidance Document

## E.3 Sizing Criteria

After you appropriately considered Stormwater Credits for your project, utilize Table E.3 below to appropriately size them to the DCV, or Design Flow Rate, as applicable. Please reference Chapter 3.5.2 of the WQMP Guidance Document for further information.

Table E.3 Treatment Control BMP Sizing

DMA Type/ID	DMA Area (square feet)	Post-Project Surface Type	Effective Impervious Fraction, I <sub>r</sub>	DMA Runoff Factor	DMA Area x Runoff Factor	N/A			
	[A]		[B]	[C]	[A] x [C]				
N/A									
						Design Storm Depth (in)	Minimum Design Capture Volume or Design Flow Rate (cubic feet or cfs)	Total Storm Water Credit % Reduction	Proposed Volume or Flow on Plans (cubic feet or cfs)
	$A_T = \sum[A]$				$\Sigma = [D]$	[E]	$[F] = \frac{[D] \times [E]}{[G]}$	$[F] \times (1 - [H])$	[I]

[B], [C] is obtained as described in Section 2.3.1 from the WQMP Guidance Document

[E] is for Flow-Based Treatment Control BMPs [E] = .2, for Volume-Based Control Treatment BMPs, [E] obtained from Exhibit A in the WQMP Guidance Document

[G] is for Flow-Based Treatment Control BMPs [G] = 43,560, for Volume-Based Control Treatment BMPs, [G] = 12

[H] is from the Total Credit Percentage as Calculated from Table E.2 above

[I] as obtained from a design procedure sheet from the BMP manufacturer and should be included in Appendix 6



## E.4 Treatment Control BMP Selection

Treatment Control BMPs typically provide proprietary treatment mechanisms to treat potential pollutants in runoff, but do not sustain significant biological processes. Treatment Control BMPs must have a removal efficiency of a medium or high effectiveness as quantified below:

- **High:** equal to or greater than 80% removal efficiency
- **Medium:** between 40% and 80% removal efficiency

Such removal efficiency documentation (e.g., studies, reports, etc.) as further discussed in Chapter 3.5.2 of the WQMP Guidance Document, must be included in Appendix 6. In addition, ensure that proposed Treatment Control BMPs are properly identified on the WQMP Site Plan in Appendix 1.

**Table E.4 Treatment Control BMP Selection**

Selected Treatment Control BMP Name or ID <sup>1</sup>	Priority Pollutant(s) of Concern to Mitigate <sup>2</sup>	Removal Efficiency Percentage <sup>3</sup>
N/A		

<sup>1</sup> Treatment Control BMPs must not be constructed within Receiving Waters. In addition, a proposed Treatment Control BMP may be listed more than once if they possess more than one qualifying pollutant removal efficiency.

<sup>2</sup> Cross Reference Table E.1 above to populate this column.

<sup>3</sup> As documented in a Co-Permittee Approved Study and provided in Appendix 6.

## Section F: Hydromodification

### F.1 Hydrologic Conditions of Concern (HCOC) Analysis

Once you have determined that the LID design is adequate to address water quality requirements, you will need to assess if the proposed LID Design may still create a HCOC. Review Chapters 2 and 3 (including Figure 3-7) of the WQMP Guidance Document to determine if your project must mitigate for Hydromodification impacts. If your project meets one of the following criteria which will be indicated by the check boxes below, you do not need to address Hydromodification at this time. However, if the project does not qualify for Exemptions 1, 2 or 3, then additional measures must be added to the design to comply with HCOC criteria. This is discussed in further detail below in Section F.2.

**HCOC EXEMPTION 1:** The Priority Development Project disturbs less than one acre. The Copermitttee has the discretion to require a Project-Specific WQMP to address HCOCs on projects less than one acre on a case by case basis. The disturbed area calculation should include all disturbances associated with larger common plans of development.

Does the project qualify for this HCOC Exemption?       Y     N

If Yes, HCOC criteria do not apply.

**HCOC EXEMPTION 2:** The volume and time of concentration<sup>1</sup> of storm water runoff for the post-development condition is not significantly different from the pre-development condition for a 2-year return frequency storm (a difference of 5% or less is considered insignificant) using one of the following methods to calculate:

- Riverside County Hydrology Manual
- Technical Release 55 (TR-55): Urban Hydrology for Small Watersheds (NRCS 1986), or derivatives thereof, such as the Santa Barbara Urban Hydrograph Method
- Other methods acceptable to the Co-Permittee

Does the project qualify for this HCOC Exemption?       Y     N

If Yes, report results in Table F.1 below and provide your substantiated hydrologic analysis in Appendix 7.

**Table F.1** Hydrologic Conditions of Concern Summary

	2 year – 24 hour		
	Pre-condition	Post-condition	% Difference
<b>Time of Concentration</b>			
<b>Volume (Cubic Feet)</b>			

<sup>1</sup> Time of concentration is defined as the time after the beginning of the rainfall when all portions of the drainage basin are contributing to flow at the outlet.

**HCOC EXEMPTION 3:** All downstream conveyance channels to an adequate sump (for example, Prado Dam, Lake Elsinore, Canyon Lake, Santa Ana River, or other lake, reservoir or naturally erosion resistant feature) that will receive runoff from the project are engineered and regularly maintained to ensure design flow capacity; no sensitive stream habitat areas will be adversely affected; or are not identified on the Co-Permittees Hydromodification Susceptibility Maps.

Does the project qualify for this HCOC Exemption?       Y     N

If Yes, HCOC criteria do not apply and note below which adequate sump applies to this HCOC qualifier:

While the project's runoff will infiltrate runoff up to and including the 100-year storm event in the infiltration basin, any excess runoff will overflow through an emergency overflow parkway drain and then enter the storm drain in Iris Avenue. The runoff will then enter the Kitching Street Channel, which then joins the Perris Valley Channel. It will then flow into the San Jacinto River and outlet into Canyon Lake.

## F.2 HCOC Mitigation

If none of the above HCOC Exemption Criteria are applicable, HCOC criteria is considered mitigated if they meet one of the following conditions:

- a. Additional LID BMPS are implemented onsite or offsite to mitigate potential erosion or habitat impacts as a result of HCOCs. This can be conducted by an evaluation of site-specific conditions utilizing accepted professional methodologies published by entities such as the California Stormwater Quality Association (CASQA), the Southern California Coastal Water Research Project (SCCRWP), or other Co-Permittee approved methodologies for site-specific HCOC analysis.
- b. The project is developed consistent with an approved Watershed Action Plan that addresses HCOC in Receiving Waters.
- c. Mimicking the pre-development hydrograph with the post-development hydrograph, for a 2-year return frequency storm. Generally, the hydrologic conditions of concern are not significant, if the post-development hydrograph is no more than 10% greater than pre-development hydrograph. In cases where excess volume cannot be infiltrated or captured and reused, discharge from the site must be limited to a flow rate no greater than 110% of the pre-development 2-year peak flow.

Be sure to include all pertinent documentation used in your analysis of the items a, b or c in Appendix 7.

Note: The project site is also exempt from HCOC per the HCOC Applicability Map.

## Section G: Source Control BMPs

Source control BMPs include permanent, structural features that may be required in your project plans — such as roofs over and berms around trash and recycling areas — and Operational BMPs, such as regular sweeping and “housekeeping”, that must be implemented by the site’s occupant or user. The MEP standard typically requires both types of BMPs. In general, Operational BMPs cannot be substituted for a feasible and effective permanent BMP. Using the Pollutant Sources/Source Control Checklist in Appendix 8, review the following procedure to specify Source Control BMPs for your site:

1. **Identify Pollutant Sources:** Review Column 1 in the Pollutant Sources/Source Control Checklist. Check off the potential sources of Pollutants that apply to your site.
2. **Note Locations on Project-Specific WQMP Exhibit:** Note the corresponding requirements listed in Column 2 of the Pollutant Sources/Source Control Checklist. Show the location of each Pollutant source and each permanent Source Control BMP in your Project-Specific WQMP Exhibit located in Appendix 1.
3. **Prepare a Table and Narrative:** Check off the corresponding requirements listed in Column 3 in the Pollutant Sources/Source Control Checklist. In the left column of Table G.1 below, list each potential source of runoff Pollutants on your site (from those that you checked in the Pollutant Sources/Source Control Checklist). In the middle column, list the corresponding permanent, Structural Source Control BMPs (from Columns 2 and 3 of the Pollutant Sources/Source Control Checklist) used to prevent Pollutants from entering runoff. **Add additional narrative** in this column that explains any special features, materials or methods of construction that will be used to implement these permanent, Structural Source Control BMPs.
4. **Identify Operational Source Control BMPs:** To complete your table, refer once again to the Pollutant Sources/Source Control Checklist. List in the right column of your table the Operational BMPs that should be implemented as long as the anticipated activities continue at the site. Copermittee stormwater ordinances require that applicable Source Control BMPs be implemented; the same BMPs may also be required as a condition of a use permit or other revocable Discretionary Approval for use of the site.

**Table G.1** Permanent and Operational Source Control Measures

Potential Sources of Runoff pollutants	Permanent Structural Source Control BMPs	Operational Source Control BMPs
A. On-site storm drain inlets	Locations of inlets. Install storm drain markers "Only Rain Down the Drain / Drains to Lake"	Maintain and periodically repaint or replace inlet markings. Provide stormwater pollution prevention information to new site owners, lessees, or operators. See applicable operational BMPs in Fact Sheet SC-44, “Drainage System Maintenance,” in the CASQA Stormwater Quality

		<p>Handbooks at <a href="http://www.cabmphandbooks.com">www.cabmphandbooks.com</a></p> <p>Include the following in lease agreements: "Tenant shall not allow anyone to discharge anything to storm drains or to store or deposit materials so as to create a potential discharge to storm drains."</p>
<p>D2. Landscape/ Outdoor Pesticide Use</p>	<p>Show locations of native trees or areas of shrubs and ground cover to be undisturbed and retained.</p> <p>Show stormwater treatment and hydrograph modification management BMPs. (See instructions in Chapter 3, Step 5 and guidance in Chapter 5.)</p> <p>Final landscape plans will accomplish all of the following:</p> <p>Preserve existing native trees, shrubs, and ground cover to the maximum extent possible.</p> <p>Design landscaping to minimize irrigation and runoff, to promote surface infiltration where appropriate, and to minimize the use of fertilizers and pesticides that can contribute to stormwater pollution.</p> <p>Where landscaped areas are used to retain or detain stormwater, specify plants that are tolerant of saturated soil conditions.</p> <p>Consider using pest-resistant plants, especially adjacent to hardscape.</p> <p>To ensure successful establishment, select plants appropriate to site soils, slopes, climate, sun, wind, rain, land use, air movement, ecological consistency, and plant interactions.</p>	<p>Maintain landscaping using minimum or no pesticides.</p>

<p>E. Pools, spas, ponds, decorative fountains, and other water features.</p>	<p>If the Co-Permittee requires pools to be plumbed to the sanitary sewer, place a note on the plans and state in the narrative that this connection will be made according to local requirements.</p>	<p>See applicable operational BMPs in “Guidelines for Maintaining Your Swimming Pool, Jacuzzi and Garden Fountain” at <a href="http://rcflood.org/stormwater/">http://rcflood.org/stormwater/</a></p>
<p>G. Refuse Areas</p>	<p>Show where site refuse and recycled materials will be handled and stored for pickup. See local municipal requirements for sizes and other details of refuse areas.</p> <p>If dumpsters or other receptacles are outdoors, show how the designated area will be covered, graded, and paved to prevent run-on and show locations of berms to prevent runoff from the area.</p> <p>State how site refuse will be handled and provide supporting detail to what is shown on plans.</p> <p>State that signs will be posted on or near dumpsters with the words “Do not dump hazardous materials here” or similar.</p>	<p>State how the following will be implemented:</p> <p>Provide adequate number of receptacles. Inspect receptacles regularly; repair or replace leaky receptacles. Keep receptacles covered.</p> <p>Prohibit/prevent dumping of liquid or hazardous wastes. Post “no hazardous materials” signs. Inspect and pick up litter daily and clean up spills immediately. Keep spill control materials available on-site. See Fact Sheet SC-34, “Waste Handling and Disposal” in the CASQA Stormwater Quality Handbooks at <a href="http://www.cabmphandbooks.com">www.cabmphandbooks.com</a></p>
<p>I. Outdoor storage of equipment or materials. (See rows J and K for source control measures for vehicle cleaning, repair, and maintenance.)</p>	<p>Show any outdoor storage areas, including how materials will be covered. Show how areas will be graded and berm to prevent run-on or run-off from area.</p> <p>Storage of non-hazardous liquids shall be covered by a roof and/or drain to the sanitary sewer system, and be contained by berms, dikes, liners, or vaults.</p> <p>Storage of hazardous materials and wastes must be in compliance with the local hazardous materials ordinance and a Hazardous Materials Management Plan for the site.</p> <p>Include a detailed description of materials to be stored, storage areas, and structural features to prevent pollutants from entering storm drains.</p>	

	<p>Where appropriate, reference documentation of compliance with the requirements of Hazardous Materials Programs for:</p> <ul style="list-style-type: none"> <li>-Hazardous Waste Generation</li> <li>-Hazardous Materials Release Response and Inventory</li> <li>-California Accidental Release (CalARP)</li> <li>-Aboveground Storage Tank</li> <li>-Uniform Fire Code Article 80 Section 103(b) &amp; (c) 1991</li> <li>-Underground Storage Tank</li> </ul> <p><a href="http://www.cchealth.org/groups/hazmat/">www.cchealth.org/groups/hazmat/</a></p>	
N. Fire Sprinkler Test Water	Provide a means to drain fire sprinkler test water to the sanitary sewer.	See the note in Fact Sheet SC-41, "Building and Grounds Maintenance," in the CASQA Stormwater Quality Handbooks at <a href="http://www.cabmphandbooks.com">www.cabmphandbooks.com</a>
<p>Miscellaneous Drain or Wash Water or Other Sources</p> <p>Rooftop Equipment</p> <p>Roofing, gutters, and trim.</p>	<p>Rooftop equipment with potential to produce pollutants shall be roofed and/or have secondary containment.</p> <p>Avoid roofing, gutters, and trim made of copper or other unprotected metals that may leach into runoff.</p>	
P. Plazas, sidewalks, and parking lots.		Sweep plazas, sidewalks, and parking lots regularly to prevent accumulation of litter and debris. Collect debris from pressure washing to prevent entry into the storm drain system. Collect wash water containing any cleaning agent or degreaser and discharge to the sanitary sewer not to a storm drain.

## Section H: Construction Plan Checklist

Populate Table H.1 below to assist the plan checker in an expeditious review of your project. The first two columns will contain information that was prepared in previous steps, while the last column will be populated with the corresponding plan sheets. This table is to be completed with the submittal of your final Project-Specific WQMP.

**Table H.1 Construction Plan Cross-reference**

BMP No. or ID	BMP Identifier and Description	Corresponding Plan Sheet(s)	BMP Location (Lat/Long)
Infiltration Basin	Infiltration Basin	2, 3	33.888665°/-117.228748°
DMA-4 Infiltration Trench	DMA-4 Infiltration Trench	2, 3	33.891855°/-117.229672°
DMA-5 Infiltration Trench	DMA-5 Infiltration Trench	2, 3	33.889913°/-117.230468°
DMA-6 Infiltration Trench	DMA-6 Infiltration Trench	2, 3	33.888665°/-117.228748°
DMA-8 Infiltration Trench	DMA-8 Infiltration Trench	2, 3	33.891865°/-117. 227852°

Note that the updated table — or Construction Plan WQMP Checklist — is **only a reference tool** to facilitate an easy comparison of the construction plans to your Project-Specific WQMP. Co-Permittee staff can advise you regarding the process required to propose changes to the approved Project-Specific WQMP.



## Section I: Operation, Maintenance and Funding

The Copermittee will periodically verify that Stormwater BMPs on your site are maintained and continue to operate as designed. To make this possible, your Copermittee will require that you include in Appendix 9 of this Project-Specific WQMP:

1. A means to finance and implement facility maintenance in perpetuity, including replacement cost.
2. Acceptance of responsibility for maintenance from the time the BMPs are constructed until responsibility for operation and maintenance is legally transferred. A warranty covering a period following construction may also be required.
3. An outline of general maintenance requirements for the Stormwater BMPs you have selected.
4. Figures delineating and designating pervious and impervious areas, location, and type of Stormwater BMP, and tables of pervious and impervious areas served by each facility. Geo-locating the BMPs using a coordinate system of latitude and longitude is recommended to help facilitate a future statewide database system.
5. A separate list and location of self-retaining areas or areas addressed by LID Principles that do not require specialized O&M or inspections but will require typical landscape maintenance as noted in Chapter 5, pages 85-86, in the WQMP Guidance. Include a brief description of typical landscape maintenance for these areas.

Your local Co-Permittee will also require that you prepare and submit a detailed Stormwater BMP Operation and Maintenance Plan that sets forth a maintenance schedule for each of the Stormwater BMPs built on your site. An agreement assigning responsibility for maintenance and providing for inspections and certification may also be required.

Details of these requirements and instructions for preparing a Stormwater BMP Operation and Maintenance Plan are in Chapter 5 of the WQMP Guidance Document.

**Maintenance Mechanism:** Refer to Appendix 9 for BMP Operation and Maintenance Plan Requirements.

Proposed BMPs will be maintained by a Homeowners' Association (HOA) contact David Patton.

Y       N

Include your Operation and Maintenance Plan and Maintenance Mechanism in Appendix 9. Additionally, include all pertinent forms of educational materials for those personnel that will be maintaining the proposed BMPs within this Project-Specific WQMP in Appendix 10.

# Appendix 1: Maps and Site Plans

*Location Map, WQMP Site Plan and Receiving Waters Map*



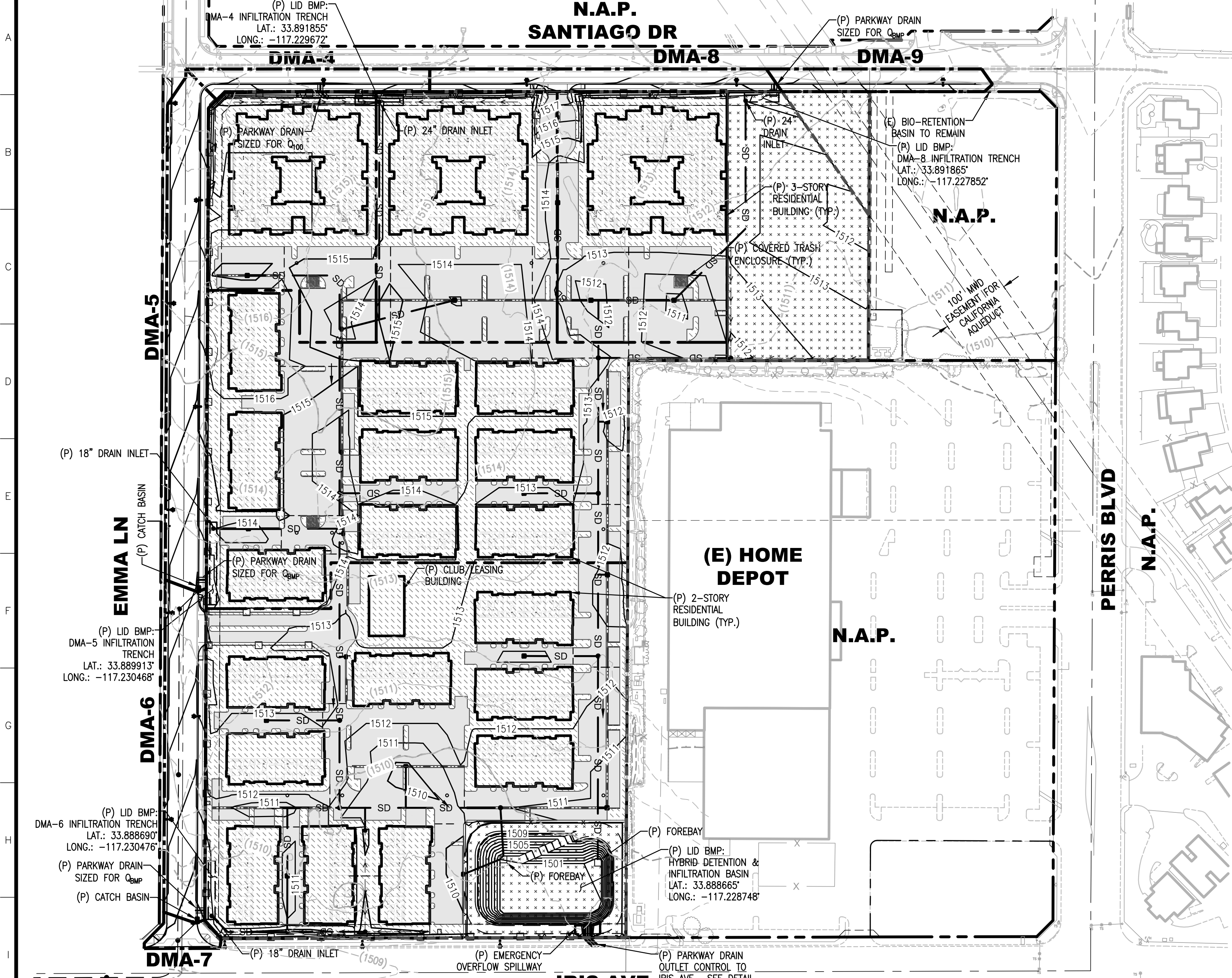

**PERMANENT SOURCE CONTROLS**

POTENTIAL SOURCES OF RUNOFF POLLUTANTS	PERMANENT CONTROLS PER PLAN WHERE APPLICABLE
A. ON-SITE STORM DRAIN INLETS	LOCATIONS OF INLETS
D2. LANDSCAPE/ OUTDOOR PESTICIDE USE	LOCATIONS OF NATIVE TREES OR AREAS OF SHRUBS AND GROUND COVER TO BE UNDISTURBED AND RETAINED. SHOW STORMWATER TREATMENT AND HYDROGRAPH MODIFICATION MANAGEMENT BMPs.
G. REFUSE AREAS	LOCATIONS WHERE SITE REFUSE AND RECYCLED MATERIALS WILL BE HANDLED AND STORED FOR PICKUP OUTDOOR DUMPSTERS OR OTHER RECEPTACLES TO BE COVERED, GRADED, AND PAVED TO PREVENT RUNON
I. OUTDOOR STORAGE OF EQUIPMENT OR MATERIALS	LOCATION OF OUTDOOR STORAGE AREAS. AREAS WILL BE GRADED AND BERMED TO PREVENT RUN-ON OR RUN-OFF FROM AREA STORAGE OF NON-HAZARDOUS LIQUIDS SHALL BE COVERED BY A ROOF AND/OR DRAIN TO THE SANITARY SEWER SYSTEM, AND BE CONTAINED BY BERMS, DIKES, LINERS, OR VAULTS. STORAGE OF HAZARDOUS MATERIALS AND WASTES MUST BE IN COMPLIANCE WITH THE LOCAL HAZARDOUS MATERIALS ORDINANCE AND A HAZARDOUS MATERIALS MANAGEMENT PLAN FOR THE SITE

NOTE: SEE TABLE AND NARRATIVE IN WQMP FOR PERMANENT CONTROLS AND OPERATIONAL BMPs NOT SHOWN IN PLAN

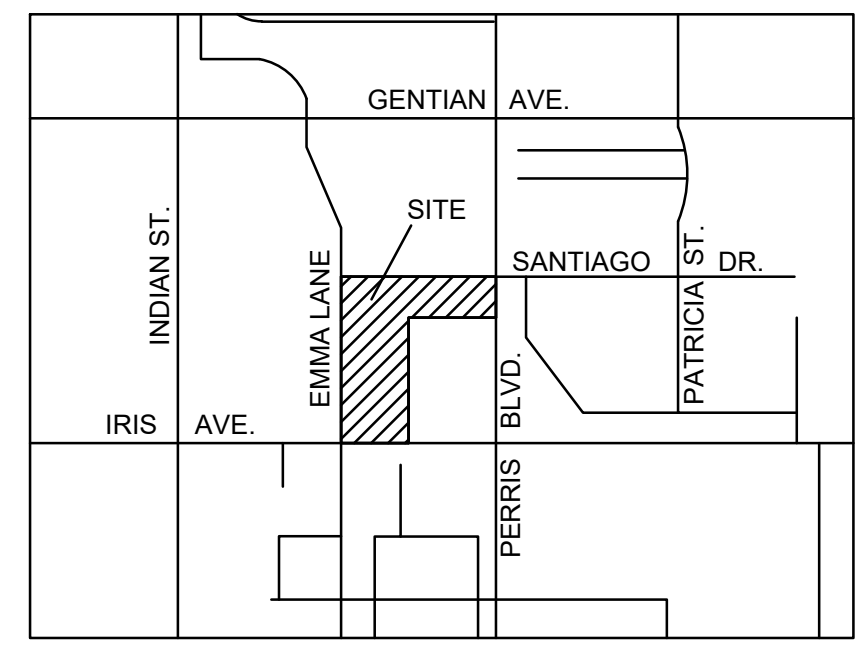

**SITE LOCATION MAP**  
NOT TO SCALE

**DMA AREA TABLE**

DMA	IMPERVIOUS (SF)	PERVIOUS (SF)	TOTAL (SF)
1	388,796	97,199	485,995
2	0	120,729	120,729
3	281,924	0	281,924
4	9,726	1,566	11,292
5	38,725	4,805	43,530
6	26,071	2,607	28,678
7	2,914	1,199	4,113
8	14,401	2,110	16,511
9	8,890	1,340	10,230
ALL	771,447	231,555	1,003,002

**LEGEND**

- PROPOSED BUILDING
- PROPOSED CURB OR CURB & GUTTER
- STORM DRAIN INLET LOCATION
- (P) STORM DRAIN
- DMA-1 RESIDENTIAL (MIXED SURFACE TYPES)
- DMA-2 OPEN SPACE (ORNAMENTAL LANDSCAPE)
- DMA-3 STREETS (CONCRETE OR ASPHALT)
- PROJECT BOUNDARY
- DRAINAGE MANAGEMENT AREA
- TREE LINE/VEGETATION TO REMAIN
- TREE TO REMAIN

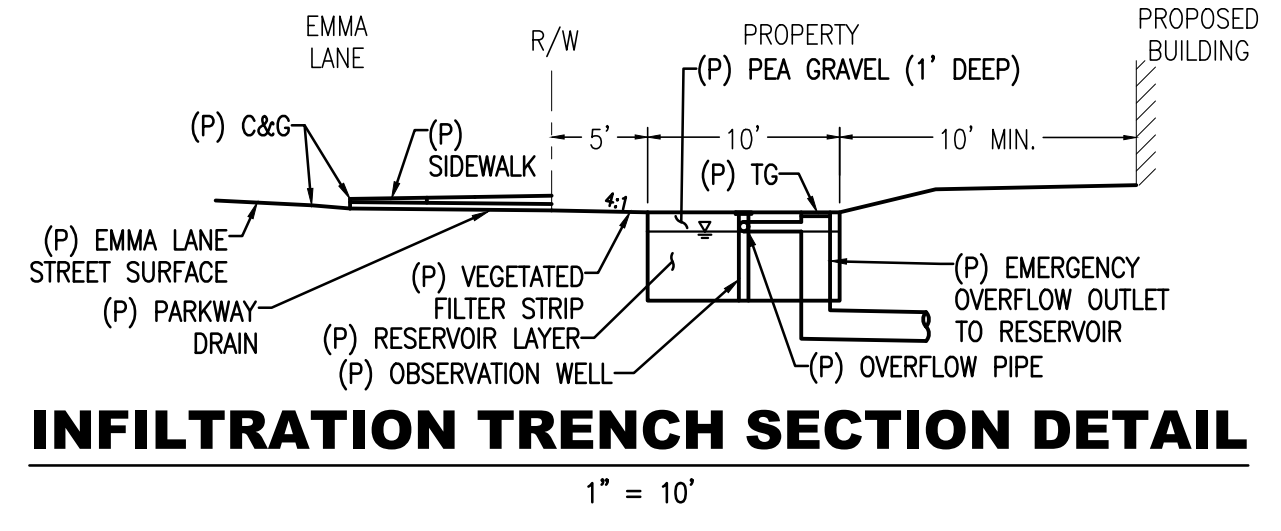

**INFILTRATION TRENCH SECTION DETAIL**  
1" = 10'

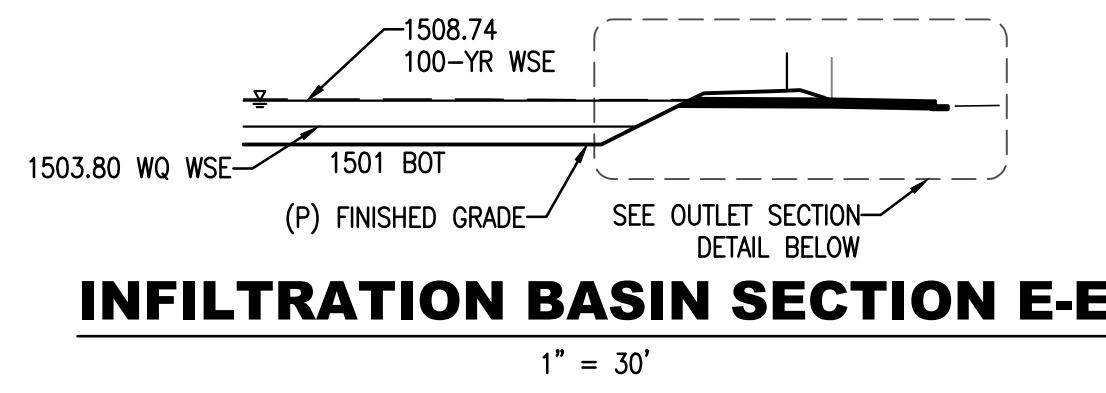

**INFILTRATION BASIN SECTION E-E**  
1" = 30'

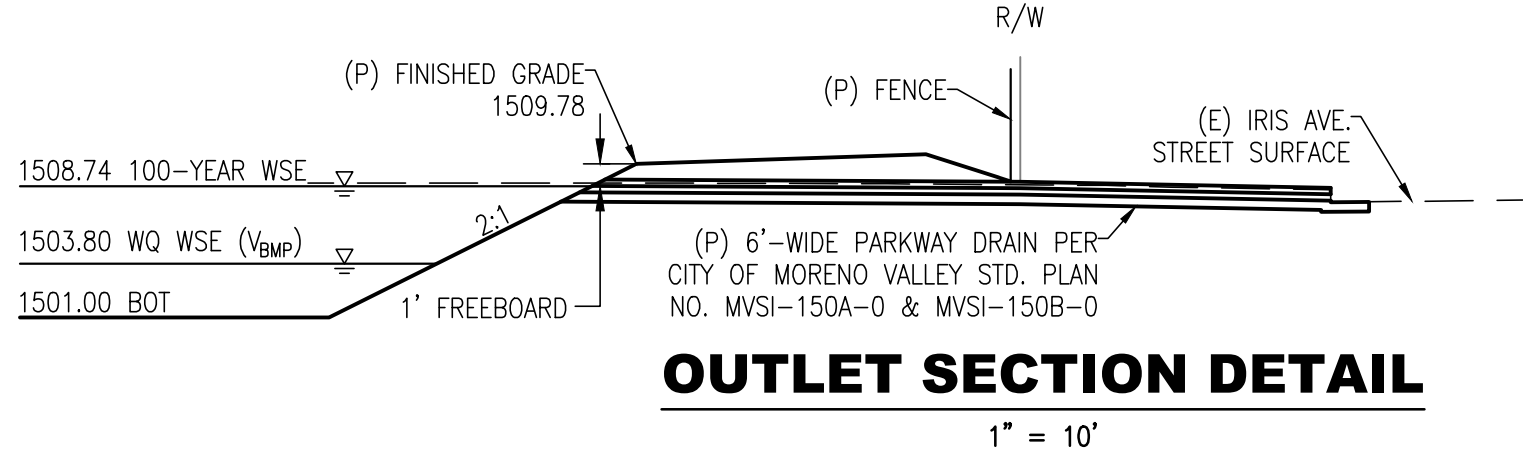

**OUTLET SECTION DETAIL**  
1" = 10'

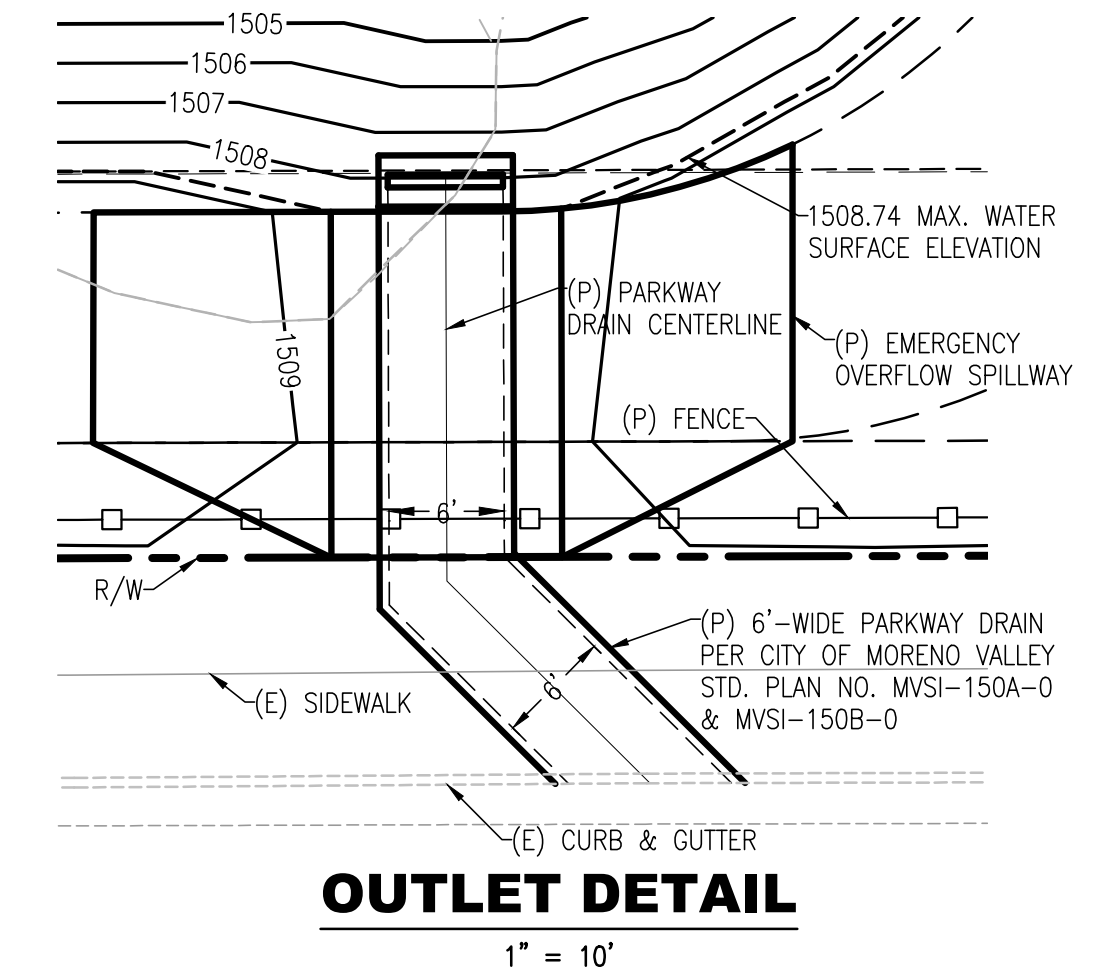

**OUTLET DETAIL**  
1" = 10'

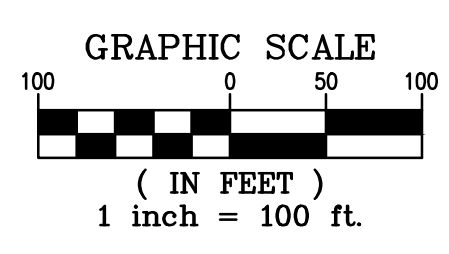

**UNDERGROUND SERVICE ALERT**  
CALL-TOLL FREE 1-800-227-2600  
TWO WORKING DAYS BEFORE YOU DIG

NOTE: WORK CONTAINED WITHIN THESE PLANS SHALL NOT COMMENCE UNTIL AN ENCROACHMENT PERMIT AND/OR A GRADING PERMIT HAS BEEN ISSUED.  
THE PRIVATE ENGINEER SIGNING THESE PLANS IS RESPONSIBLE FOR ASSURING THE ACCURACY AND ACCEPTABILITY OF THE DESIGN HEREON. IN THE EVENT OF DISCREPANCIES ARISING AFTER CITY APPROVAL OR DURING CONSTRUCTION, THE PRIVATE ENGINEER SHALL BE RESPONSIBLE FOR DETERMINING AN ACCEPTABLE SOLUTION AND REVISING THE PLANS FOR APPROVAL BY THE CITY.

MARK	BY	DATE	REVISIONS	APPR.	DATE

CITY OF MORENO VALLEY  
APPROVED BY: \_\_\_\_\_ DATE: \_\_\_\_\_  
CITY ENGINEER

SEAL-ENGINEER  
LICENSED PROFESSIONAL ENGINEER  
JOHN NOURZAD  
No. C46039  
Exp. 12/31/2020  
CIVIL  
STATE OF CALIFORNIA

**GreenbergFarrow**  
30 Executive Park, Suite 100  
Irvine, CA 92614  
t: 949 296 0450 f: 949 296 0479  
PREPARED BY: \_\_\_\_\_ DATE: \_\_\_\_\_  
JOHN NOURZAD RCE 46039, EXP. 12/31/2020

JOB NO. 20140909.0 BENCHMARK

CITY OF MORENO VALLEY  
PERRIS AT PENTECOSTAL  
WQMP SITE PLAN  
INITIAL DESIGN DATE: 06/05/20  
FOR: \_\_\_\_\_ W.O. \_\_\_\_\_ CITY FILE NO. \_\_\_\_\_

SHEET NO. WQMP-1  
OF 1 SHEET



# Caltrans Water Quality Planning Tool

The Water Quality Planning Tool was created to help planners and designers comply with environmental permits. It uses a map interface to find information based on a project's location. **This application is being updated for digital accessibility and will continue to function while updates are in progress.**

**Layers**

- 303(d) List and TMDLs 2014-2016 ([Legend](#))
- Areas of Special Biological Significance
- Arid and Semi-Arid Regions
- Caltrans Districts
- Caltrans Facilities
- Caltrans Tie
- 1 Monitoring Sites
- Calwater Watersheds
- Coastal Zone
- Counties

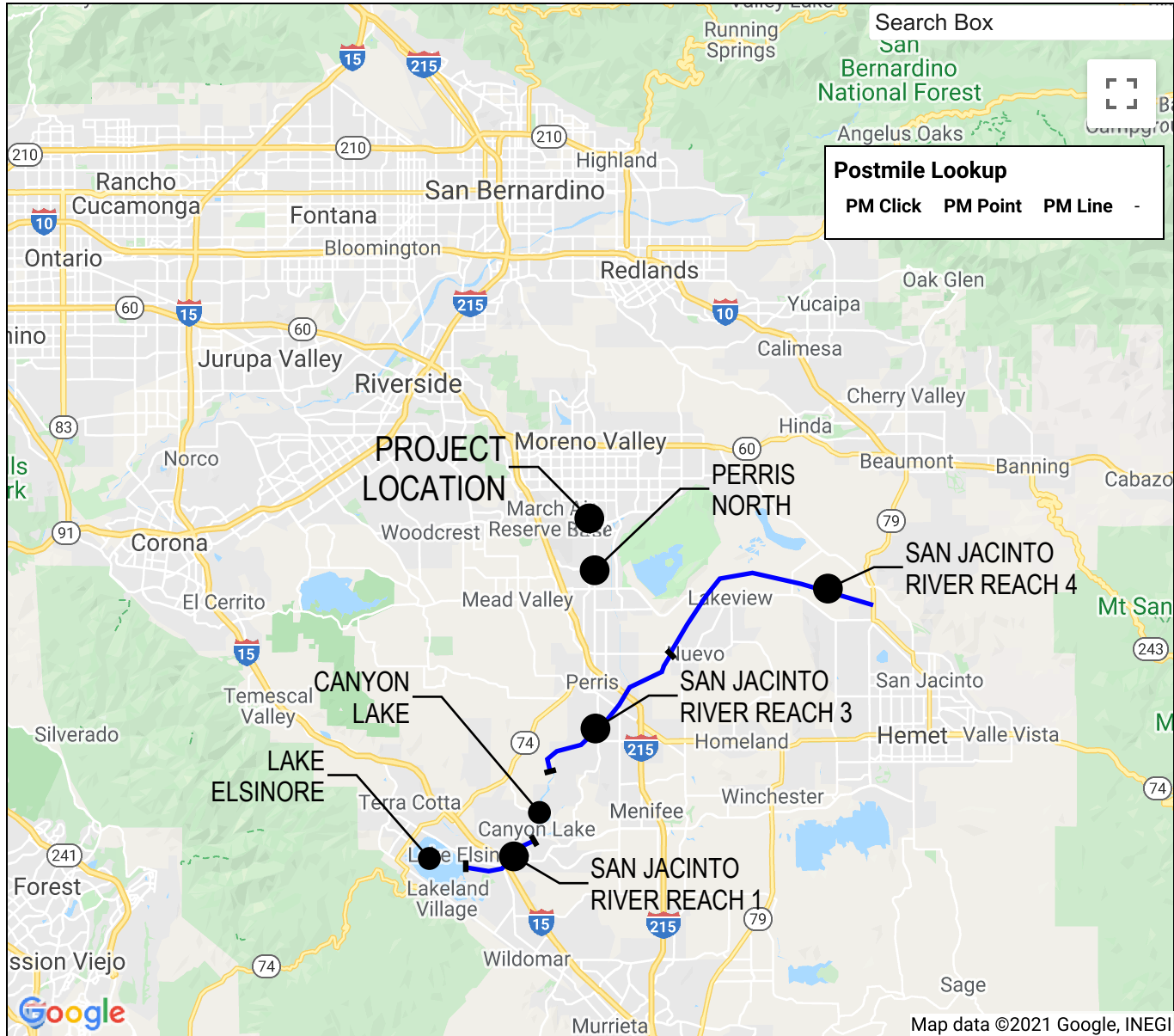

**Information**  
 Hover over a layer name for a description. Additional information, tables, coordinates, and links are below the map. [Help](#)

## Watershed Information

### CALWATER WATERSHED

Hydrologic Unit	SAN JACINTO VALLEY	Hydrologic Area	Perris	Hydrologic Sub-Area #	802.11
Hydrologic Sub-Area Name	Perris Valley	Planning Watershed	4802110000	HSA Area (acres)	106456
Latitude, Longitude	33.8896, -117.2294				

### WATERSHED BOUNDARY DATASET

Watershed	Lower San Jacinto River	Subwatershed	Moreno Valley	Hydrologic Unit Code	180702020304
Average Annual Precipitation (inches)	13.06				

## TMDLs & 303(d) Listed Water Bodies (2014 - 2016 List)

**Key:** Water body on 303(d) list Water body with a TMDL

Name	Pollutant	Size	Status
<a href="#">Canyon Lake (Railroad Canyon Reservoir)</a>	Nutrients	452.68 Acres	Being addressed with USEPA approved TMDL

## Water Quality Objectives

The following waterbodies are in or near HSA 802.11. Click on the waterbody to get information on water quality objectives and beneficial uses

Waterbody Name	Beneficial Uses	Sediment-Sensitive Waterbody
<a href="#">Anza Park Drain</a>	MUN, REC1, REC2, SPWN, WARM, WILD	False
<a href="#">Bautista Creek - Headwaters to Debris Dam</a>	AGR, COLD, GWR, MUN, REC1, REC2, WILD	False
<a href="#">Birch Creek - Tributaries to Birch Creek - Valley Reaches</a>	COLD, GWR, MUN, REC1, REC2, WILD	False
<a href="#">Black Mountain Stream - Tributaries to Black Mountain Stream Creek</a>	AGR, GWR, MUN, REC1, REC2, WARM, WILD	False
<a href="#">Black Mountain Stream - Tributary to San Jacinto River</a>	AGR, GWR, MUN, REC1, REC2, WARM, WILD	False
<a href="#">Canyon Lake (Railroad Canyon Reservoir)</a>	AGR, GWR, MUN, REC1, REC2, WARM, WILD	False
<a href="#">Coyote Creek (within Santa Ana Regional boundary) - San Gabriel River Drainage</a>	MUN, REC1, REC2, WARM, WILD	False
<a href="#">Elsinore, Lake</a>	ALL	False
<a href="#">Evans, Lake</a>	ALL	False
<a href="#">Fulmore, Lake</a>	ALL	False
<a href="#">Hurkey Stream - Tributaries to Black Hurkey Stream</a>	AGR, GWR, MUN, REC1, REC2, WARM, WILD	False
<a href="#">Indian Hurkey Stream - Trbutary to San Jacinto River</a>	AGR, GWR, MUN, REC1, REC2, WARM, WILD	False
<a href="#">Indian Stream - Tributaries to Black Indian Stream</a>	AGR, GWR, MUN, REC1, REC2, WARM, WILD	False
<a href="#">Juaro Canyon Streams - Tributaries to Black Juaro Canyon Streams</a>	AGR, GWR, MUN, REC1, REC2, WARM, WILD	False
<a href="#">Juaro Canyon Streams - Tributary to San Jacinto River</a>	AGR, GWR, MUN, REC1, REC2, WARM, WILD	False
<a href="#">Lake Elsinore - San Jacinto River Basin</a>	REC1, REC2, WARM, WILD	False
<a href="#">Lake Evans - Upper Santa Ana River Basin</a>	COLD, REC1, REC2, WARM, WILD	False
<a href="#">Lake Fulmor - San Jacinto River Basin</a>	AGR, COLD, MUN, REC1, REC2, WARM, WILD	False
<a href="#">Lake Lee - Upper Santa Ana River Basin</a>	AGR, GWR, IND, REC1, REC2, WARM, WILD	False
<a href="#">Lake Mathews - Upper Santa Ana River Basin</a>	AGR, GWR, IND, MUN, PROC, RARE, REC1, REC2, WARM, WILD	False
<a href="#">Lake Perris - San Jacinto River Basin</a>	AGR, COLD, GWR, IND, MUN, PROC, REC1, REC2, WARM, WILD	False
<a href="#">Little San Gorgonio Creek - Tributaries to Little San Gorgonio Creek - Valley Reaches</a>	COLD, GWR, MUN, REC1, REC2, WILD	False
<a href="#">Logan Stream - Tributaries to Logan Stream</a>	AGR, GWR, MUN, REC1, REC2, WARM, WILD	False
<a href="#">Logan Stream - Tributary to San Jacinto River</a>	AGR, GWR, MUN, REC1, REC2, WARM, WILD	False
<a href="#">Mathews, Lake</a>	ALL	False
<a href="#">Mockingbird Reservoir</a>	ALL	False
<a href="#">Mockingbird Reservoir - Upper Santa Ana River Basin</a>	MUN, REC1, REC2, WARM, WILD	False
<a href="#">Oak Glen Creek - Tributaries to Oak Glen Creek - Valley Reaches</a>	GWR, MUN, REC1, REC2, WARM, WILD	False
<a href="#">Offshore Zone - Water between Nearshore Zone and Limit of State Waters</a>	COMM, IND, MAR, MUN, NAV, RARE, REC1, REC2, SPWN, WILD	False

<a href="#">Ferris, Lake</a>	ALL	False
<a href="#">Poppet Stream - Tributaries to Black Poppet Stream</a>	AGR, GWR, MUN, REC1, REC2, WARM, WILD	False
<a href="#">Poppet Stream - Tributary to San Jacinto River</a>	AGR, GWR, MUN, REC1, REC2, WARM, WILD	False
<a href="#">Potato Canyon Creek - Tributaries to Potato Canyon Creek - Valley Reaches</a>	COLD, GWR, MUN, REC1, REC2, WILD	False
<a href="#">Protrero Creeks - Tributaries to Black Protrero Creeks</a>	AGR, GWR, MUN, REC1, REC2, WARM, WILD	False
<a href="#">Protrero Creeks - Tributary to San Jacinto River</a>	AGR, GWR, MUN, REC1, REC2, WARM, WILD	False
<a href="#">Salt Creek</a>	REC1, REC2, WARM, WILD	False
<a href="#">San Jacinto River</a>	ALL	False
<a href="#">San Jacinto River</a>	ALL	False
<a href="#">San Jacinto River</a>	ALL	False
<a href="#">San Jacinto River</a>	ALL	False
<a href="#">San Jacinto River - Canyon Lake to Nuevo Road</a>	AGR, GWR, REC1, REC2, WARM, WILD	False
<a href="#">San Jacinto River - Lake Elsinor to Canyon Lake</a>	AGR, GWR, MUN, REC1, REC2, WARM, WILD	False
<a href="#">San Jacinto River Reach 4 - Nuevo Road to North-South Mid-Section Line, T4S/R1W-S8</a>	AGR, GWR, REC1, REC2, WARM, WILD	False
<a href="#">San Jacinto River Reach 5 - North-South Mid-Section Line, T4S/R1W-S8, to Confluence with Poppet Cr</a>	GWR, REC1, REC2, WARM, WILD	False
<a href="#">San Jacinto River Reach 5 - North-South Mid-Section Line, T4S/R1W-S8, to Confluence with Poppet Cr</a>	AGR	False
<a href="#">San Jacinto River Reach 6 - Popper Creek to Cranston Bridge</a>	AGR, GWR, MUN, REC1, REC2, WARM, WILD	False
<a href="#">San Jacinto River Reach 7 - Cranston Bridge to Lake Hemet</a>	AGR, COLD, GWR, MUN, REC1, REC2, WILD	False
<a href="#">San Timoteo Creek Reach 2 - Gage at San Timoteo Canyon Road to Confluence with Yucaipa Creek</a>	ALL	False
<a href="#">San Timoteo Creek Reach 3 - Confluence with Yucaipa Creek to Bunker Hill II Croudwater Subbaisn bondary (T2S/R3W-24_)</a>	GWR, REC1, REC2, WARM, WILD	False
<a href="#">San Timoteo Creek Reach 4 - Bunker Hill II growndwater Subbasin boundry to Confluence with little San Gorgonio and Noble Creeks (Headwaters of San Tim</a>	GWR, REC1, REC2, WARM, WILD	False
<a href="#">Santa Ana River, Reach 4-Mission Blvd. In Riverside to San Jacinto Fault in San Bernardino</a>	GWR, REC1, REC2, WARM, WILD	False
<a href="#">Santiago Creek Reach 3 - Irvine lake to Modjeska Canyon</a>	REC1, WARM	False
<a href="#">Stone Creek</a>	AGR, COLD, GWR, MUN, REC1, REC2, WILD	False
<a href="#">Strawberry Creek and San Jacinto River, North Fork</a>	AGR, COLD, GWR, MUN, REC1, REC2, WILD	False
<a href="#">Sunnyslope Cahnnel</a>	MUN, REC1, REC2, SPWN, WARM, WILD	False
<a href="#">Temescal Creek Reach 4 - Lee Lake to Mid-section 17 (downstream end of freeway cut) to Elsinor Grown</a>	AGR, GWR, RARE, REC1, REC2, WARM, WILD	False
<a href="#">Temescal Creek Reach 5 - Mid-section line of Section 17 (Downstream end of freeway cut) to Elsinore G</a>	AGR, GWR, RARE, REC1, REC2, WARM, WILD	False
<a href="#">Temescal Creek Reach 6 - Elsinore Groundwater Subbasin Boundry to Lake Elsinor Outlet</a>	GWR, REC1, REC2, WARM, WILD	False
<a href="#">Tequesquite Arroyo (Sycamore Creek)</a>	GWR, REC1, REC2, SPWN, WARM, WILD	False
<a href="#">Yucaipa Creek - Tributaries to Yucaipa Creek - Valley Reaches</a>	COLD, GWR, MUN, REC1, REC2, WILD	False

## Caltrans Facilities

MAINTENANCE STATIONS

FREEWAYS AND HIGHWAYS

Name Address

Route Length (miles)

60 6.9

74 12.2

215 14.1

## PARK & RIDE LOTS

Name	District	County	Route	Post Mile
PIGEON PASS	8	RIV	60	14.3

## REST AREAS

Name	District	County	Route	Post Mile
------	----------	--------	-------	-----------

## Additional Information

---

[Help](#) for the Water Quality Planning Tool

[TMDL](#) information from the SWRCB

[Construction General Permit](#) information from the SWRCB

[Groundwater Depth](#) information from the California Department of Water Resources

R Factor erosivity [calculations](#)

# Appendix 2: Construction Plans

*Grading and Drainage Plans*

















# Appendix 3: Soils Information

*Geotechnical Study and Other Infiltration Testing Data*



# Geotechnical Engineering Report

---

**Proposed Commercial and Residential Development  
Perris Boulevard and Santiago Drive Intersection  
Moreno Valley, Riverside County, California**

November 26, 2019  
Terracon Project No. CB195149

**Prepared for:**

Perris at Pentecostal, LLC  
Irvine, California

**Prepared by:**

Terracon Consultants, Inc.  
Colton, California



November 26, 2019

Perris at Pentecostal, LLC  
41 Corporate Park  
Irvine, California 92606

Attn: David Patton  
E: dpatton545@gmail.com

**Re: Geotechnical Engineering Report**  
Proposed Commercial and Residential Development  
Perris Boulevard and Santiago Drive Intersection  
Moreno Valley, Riverside County, California  
Terracon Project No. CB195149

Dear Mr. Patton:

We have completed the Geotechnical Engineering services for the above referenced project. This study was performed in general accordance with Terracon Proposal No. PCB195149 dated November 7, 2019. This report presents the findings of the subsurface exploration and provides geotechnical recommendations concerning the design of infiltration system for the proposed project.

We appreciate the opportunity to be of service to you on this project. If you have any questions concerning this report or if we may be of further service, please contact us.

Sincerely,  
**Terracon Consultants, Inc.**



Ali Tabatabaei, Ph.D., P.E.  
Geotechnical Project Engineer

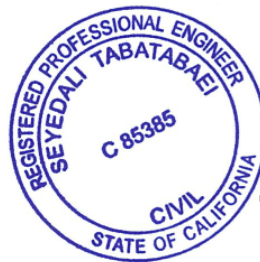

F. Fred Buhamdan, P.E.  
Office Manager

## REPORT TOPICS

INTRODUCTION.....	1
SITE CONDITIONS.....	1
PROJECT DESCRIPTION.....	2
GEOTECHNICAL CHARACTERIZATION.....	2
STORM WATER MANAGEMENT .....	3
GENERAL COMMENTS.....	5

**Note:** This report was originally delivered in a web-based format. **Orange Bold** text in the report indicates a referenced section heading. The PDF version also includes hyperlinks which direct the reader to that section and clicking on the *GeoReport* logo will bring you back to this page. For more interactive features, please view your project online at [client.terracon.com](http://client.terracon.com).

## ATTACHMENTS

**EXPLORATION AND TESTING PROCEDURES**

**SITE LOCATION AND EXPLORATION PLANS**

**EXPLORATION RESULTS**

**SUPPORTING INFORMATION**

**Note:** Refer to each individual Attachment for a listing of contents.



# Geotechnical Engineering Report

## Proposed Commercial and Residential Development Perris Boulevard and Santiago Drive Intersection Moreno Valley, Riverside County, California

Terracon Project No. CB195149  
November 26, 2019

### INTRODUCTION

This report presents the results of our subsurface exploration and geotechnical engineering services performed for the proposed commercial and residential development to be located at the southwest corner of Perris Boulevard and Santiago Drive Intersection in Moreno Valley, Riverside County, California. The purpose of these services is to provide information and geotechnical engineering recommendations relative to:

- § Subsurface soil conditions
- § Groundwater conditions
- § Recommendation for on-site infiltration rate

The geotechnical engineering Scope of Services for this project included the advancement of 9 test borings to depths ranging from approximately 5 to 16½ feet below existing site grades.

Maps showing the site and boring locations are shown in the **Site Location** and **Exploration Plan** sections, respectively. The results of the laboratory testing performed on soil samples obtained from the site during the field exploration are included on the boring logs and/or as separate graphs in the **Exploration Results** section.

### SITE CONDITIONS

The following description of site conditions is derived from our site visit in association with the field exploration and our review of publicly available geologic and topographic maps.

Item	Description
Parcel Information	The project site is an approximately 14.10-acre tract of land located at the southwest corner of Perris Boulevard and Santiago Drive Intersection in Moreno Valley, Riverside County, California. The approximate coordinates of the site are: 33.8906°N / 117.2288°W See <b>Site Location</b>

Item	Description
<b>Current Ground Cover</b>	The site is covered with native soils and grass.
<b>Existing Topography</b>	The project site is relatively flat.

## PROJECT DESCRIPTION

Our initial understanding of the project was provided in our proposal and was discussed during project planning. A period of collaboration has transpired since the project was initiated, and our final understanding of the project conditions is as follows:

Item	Description
<b>Proposed Development</b>	The project site includes three (3) parcels, (Parcel A through C) with an approximate total area of 14.10-acre. These parcels include commercial and residential developments with associated parking lots and driveways. The development will also include on-site stormwater infiltration retention basins. Bottom depth of retention basins are unknown at the time of this report preparation. <b>The goal of this study is conducting percolation tests to estimate infiltration rates at the locations of the borings</b>
<b>Grading Requirements</b>	Assumed to be less than two feet
<b>Below Grade Structures</b>	Infiltration system

## GEOTECHNICAL CHARACTERIZATION

### Subsurface Profile

We have developed a general characterization of the subsurface soil and groundwater conditions based upon our review of the data and our understanding of the geologic setting and planned construction. The following table provides our geotechnical characterization.

The geotechnical characterization forms the basis of our geotechnical calculations and evaluation of site preparation, foundation options and pavement options. As noted in **General Comments**, the characterization is based upon widely spaced exploration points across the site, and variations are likely.

Conditions encountered at each boring location are indicated on the individual boring logs shown in the **Exploration Results** section and are attached to this report. Stratification boundaries on the boring logs represent the approximate location of changes in native soil types; in situ, the transition between materials may be gradual.

Stratum	Approximate Depth to Bottom of Stratum (feet)	Material Description <sup>1</sup>	Consistency/ Density
Stratum I	5 to 16.5	Silty sand, brown	Medium dense

1. The soil materials encountered are not expected to experience substantial volumetric changes (shrink/swell) with fluctuations in moisture content.

## Groundwater Conditions

The borings were advanced using continuous flight auger drilling techniques that allow short-term groundwater observations to be made while drilling. Groundwater seepage was not observed within the maximum depths of exploration during or at the completion of drilling.

Groundwater level fluctuations occur due to seasonal variations in the amount of rainfall, runoff and other factors not evident at the time the borings were performed.

## Historic Groundwater Conditions

The site is located in Section 19 of Township 3 South, Range 3 West of the San Jacinto groundwater basin. Historic depth-to-groundwater data in the vicinity of the site indicate that high historic groundwater to be around 40 feet at the project site.

## STORM WATER MANAGEMENT

Seven in-situ infiltration tests (falling head borehole permeability) were performed at the site to approximate depths of 5 to 10 feet bgs. The objective of the infiltration testing is to provide infiltration rates for designing the proposed infiltration system. A 2-inch thick, 3/8 inch gravel layer was placed in the bottom of each boring after the borings were drilled to investigate the soil profile.

Three inch diameter perforated pipes were installed on top of the gravel layer. Gravel was used to backfill between the perforated pipes and the boring sidewall. The borings were then filled with water for a pre-soak period.

At the beginning of each test, the pipes were refilled with water and readings were taken at periodic time intervals as the water level dropped. The soil at the percolation test locations was classified in the field using a visual/manual procedure. The infiltration velocity is presented as the infiltration rate and is summarized in the following table. The infiltration rates provided do not include safety factors.

Test Location	Test Depth (ft.) <sup>1</sup>	Soil Type	Percolation Rate Average (in./hr.)	Infiltration Rate Average (in./hr.) <sup>2</sup>
P-1	10	SM	57.60	2.41
P-2	10	SM	69.60	2.89
P-3	10	SM	167.28	8.59
P-4	5	SM	170.40	8.63
P-5	5	SM	105.60	4.88
P-6	10	SM	103.68	4.76
P-7	5	SM	348.00	23.57

1. Below existing ground surface.
2. If proposed infiltration system will mainly rely on vertical downward seepage, the correlated infiltration rates should be used. The correlated infiltration rates were calculated using the Porchet method.

The above infiltration rates determined by the shallow percolation test method are based on field test results utilizing clear water. Infiltration rates can be affected by silt buildup, debris, degree of soil saturation, site variability and other factors. The rate obtained at specific location and depth is representative of the location and depth tested and may not be representative of the entire site. Application of an appropriate safety factor is prudent to account for subsoil inconsistencies, possible compaction related to site grading, and potential silting of the percolating soils, depending on the application.

The design engineer should also check with the local agency for the limitation of the infiltration rate allowed in the design. If the maximum allowable design infiltration rate is lower than the above recommended rate, the maximum allowable design infiltration rate should be used. The designer of the basins should also consider other possible site variability in the design.

The percolation test was performed with clear water, whereas the storm water will likely not be clear, but may contain organics, fines, and grease/oil. The presence of these deleterious materials will tend to decrease the rate that water percolates from the infiltration systems. Design of the storm water infiltration systems should account for the presence of these materials and should incorporate structures/devices to remove these deleterious materials.

Based on the soils encountered in our borings, we expect the percolation rates of the soils could be different than measured in the field due to variations in fines and gravel content. The design elevation and size of the proposed infiltration system should account for this expected variability in infiltration rates.

Infiltration testing should be performed after construction of the infiltration system to verify the design infiltration rates. It should be noted that siltation and vegetation growth along with other factors may affect the infiltration rates of the infiltration areas. The actual infiltration rate may vary

from the values reported here. Infiltration systems should be located at least 10 feet from any existing or proposed foundation system.

## **GENERAL COMMENTS**

Our analysis and opinions are based upon our understanding of the project, the geotechnical conditions in the area, and the data obtained from our site exploration. **Natural variations will occur between exploration point locations** or due to the modifying effects of construction or weather. The nature and extent of such variations may not become evident until during or after construction. Terracon should be retained as the Geotechnical Engineer, where noted in this report, to provide observation and testing services during pertinent construction phases.

If variations appear, we can provide further evaluation and supplemental recommendations. If variations are noted in the absence of our observation and testing services on-site, we should be immediately notified so that we can provide evaluation and supplemental recommendations.

Our Scope of Services does not include either specifically or by implication any environmental or biological (e.g., mold, fungi, bacteria) assessment of the site or identification or prevention of pollutants, hazardous materials or conditions. If the owner is concerned about the potential for such contamination or pollution, other studies should be undertaken.

Our services and any correspondence or collaboration through this system are intended for the sole benefit and exclusive use of our client for specific application to the project discussed and are accomplished in accordance with generally accepted geotechnical engineering practices with no third-party beneficiaries intended.

Any third-party access to services or correspondence is solely for information purposes to support the services provided by Terracon to our client. Reliance upon the services and any work product is limited to our client, and is not intended for third parties. Any use or reliance of the provided information by third parties is done solely at their own risk. No warranties, either express or implied, are intended or made.

Site characteristics as provided are for design purposes and not to estimate excavation cost. Any use of our report in that regard is done at the sole risk of the excavating cost estimator as there may be variations on the site that are not apparent in the data that could significantly impact excavation cost. Any parties charged with estimating excavation costs should seek their own site characterization for specific purposes to obtain the specific level of detail necessary for costing. Site safety, and cost estimating including, excavation support, and dewatering requirements/design are the responsibility of others.

**If changes in the nature, design, or location of the project are planned, our conclusions and recommendations shall not be considered valid unless we review the changes and either verify or modify our conclusions in writing.**

## ATTACHMENTS

## EXPLORATION AND TESTING PROCEDURES

### Field Exploration

Terracon conducted a total of nine (9) soil-testing borings. These borings were planned to the following extended depths below existing grades.

Number of Borings	Boring Depth (feet) <sup>1</sup>	Location
2 (B-1 and B-2)	16 ½	See <a href="#">Exploration Plan</a>
4 (Perc-1 to Perc-3 and Perc-6)	10 feet	See <a href="#">Exploration Plan</a>
3 (Perc-4, Perc-5 and Perc-7)	5 feet	See <a href="#">Exploration Plan</a>

1. Below ground surface.

**Boring Layout and Elevations:** Unless otherwise noted, Terracon personnel provided the boring layout. Coordinates were obtained with a handheld GPS unit (estimated horizontal accuracy of about ±10 feet) and approximate elevations were obtained by interpolation from the Google Earth. If elevations and a more precise boring layout are desired, we recommend borings be surveyed following completion of fieldwork.

**Subsurface Exploration Procedures:** We advance the borings with a truck-mounted drill rig using hollow-stem augers. Both a standard penetration test (SPT) sampler (2-inch outer diameter and 1-3/8-inch inner diameter) and a modified California ring-lined sampler (3-inch outer diameter and 2-3/8-inch inner diameter) are utilized in our investigation. The penetration resistance is recorded on the boring logs as the number of hammer blows used to advance the sampler in 6-inch increments (or less if noted). The samplers are driven with an automatic hammer that drops a 140-pound weight 30 inches for each blow. After the required seating, samplers are advanced up to 18 inches, providing up to three sets of blowcounts at each sampling interval. The sampling depths, penetration distances, and other sampling information are recorded on the field boring logs. The recorded blows are raw numbers without any corrections for hammer type (automatic vs. manual cathead) or sampler size (ring sampler vs. SPT sampler). Relatively undisturbed and bulk samples of the soils encountered are placed in sealed containers and returned to the laboratory for testing and evaluation.

We observe and record groundwater levels during drilling and sampling. For safety purposes, all borings are backfilled with auger cuttings after their completion. Our exploration team prepares field boring logs as part of the drilling operations. These field logs include visual classifications of the materials encountered during drilling and our interpretation of the subsurface conditions between samples.

## Geotechnical Engineering Report

Proposed Commercial and Residential Development ■ Moreno Valley, Riverside County, Califor

November 26, 2019 ■ Terracon Project No. CB195149



Final boring logs are prepared from the field logs. The final boring logs represent the Geotechnical Engineer's interpretation of the field logs and include modifications based on observations and tests of the samples in our laboratory.

### Laboratory Testing

The project engineer reviewed the field data and assigned laboratory tests to understand the engineering properties of the various soil strata, as necessary, for this project. Procedural standards noted below are for reference to methodology in general. In some cases, variations to methods were applied because of local practice or professional judgment. Standards noted below include reference to other, related standards. Such references are not necessarily applicable to describe the specific test performed.

- § Water (Moisture) Content of Soil by Mass
- § Laboratory Determination of Density (Unit Weight) of Soil Specimens
- § Particle-Size Distribution (Gradation) of Soils Using Sieve Analysis

The laboratory testing program often included examination of soil samples by an engineer. Based on the material's texture and plasticity, we described and classified the soil samples in accordance with the Unified Soil Classification System.



**SITE LOCATION**

Proposed Commercial and Residential Development ■ Moreno Valley, Riverside County, California  
November 26, 2019 ■ Terracon Project No. CB195149



DIAGRAM IS FOR GENERAL LOCATION ONLY, AND IS NOT INTENDED FOR CONSTRUCTION PURPOSES

MAP PROVIDED BY MICROSOFT BING MAPS



**EXPLORATION PLAN**

Proposed Commercial and Residential Development ■ Moreno Valley, Riverside County, California  
November 26, 2019 ■ Terracon Project No. CB195149



DIAGRAM IS FOR GENERAL LOCATION ONLY, AND IS NOT INTENDED FOR CONSTRUCTION PURPOSES

MAP PROVIDED BY MICROSOFT BING MAPS

# BORING LOG NO. B-1

**PROJECT:** Proposed Commercial and Residential Development

**CLIENT:** Perris at Pentecostal LLC  
Irvine, CA

**SITE:** Perris Boulevard & Santiago Drive  
Moreno Valley

GRAPHIC LOG	LOCATION See <a href="#">Exploration Plan</a> Latitude: 33.8913° Longitude: -117.2291°	DEPTH (Ft.)	WATER LEVEL OBSERVATIONS	SAMPLE TYPE	FIELD TEST RESULTS	WATER CONTENT (%)	DRY UNIT WEIGHT (pcf)	ATTERBERG LIMITS	PERCENT FINES
	LL-PL-PI								
DEPTH									
16.5	<b>SILTY SAND (SM)</b> , fine to coarse grained, brown to dark brown								
		5		8-8-13	3	114			
				12-16-17	4	112			
				7-10-9	2	110			
		10		8-11-14	2	103			
				12-14-21	7	106			
		15		13-19-28					
	<b>Boring Terminated at 16.5 Feet</b>								

Stratification lines are approximate. In-situ, the transition may be gradual.

Hammer Type: Automatic

Advancement Method:  
8" Hollow Stem Auger

See [Exploration and Testing Procedures](#) for a description of field and laboratory procedures used and additional data (if any).

Notes:

Abandonment Method:  
Boring backfilled with auger cuttings upon completion.

See [Supporting Information](#) for explanation of symbols and abbreviations.

**WATER LEVEL OBSERVATIONS**

Groundwater not encountered



1355 E Cooley Dr, Ste C  
Colton, CA

Boring Started: 11-20-2019

Boring Completed: 11-20-2019

Drill Rig:

Driller: 2R Drilling

Project No.: CB195149

THIS BORING LOG IS NOT VALID IF SEPARATED FROM ORIGINAL REPORT. GEO SMART LOG-NO WELL\_CB195149 PROPOSED COMMERCIAL GPJ TERRACON\_DATATEMPLATE.GDT 11/22/19

# BORING LOG NO. B-2

**PROJECT:** Proposed Commercial and Residential Development

**CLIENT:** Perris at Pentecostal LLC  
Irvine, CA

**SITE:** Perris Boulevard & Santiago Drive  
Moreno Valley

GRAPHIC LOG	LOCATION See <a href="#">Exploration Plan</a> Latitude: 33.8892° Longitude: -117.2292°	DEPTH (Ft.)	WATER LEVEL OBSERVATIONS	SAMPLE TYPE	FIELD TEST RESULTS	WATER CONTENT (%)	DRY UNIT WEIGHT (pcf)	ATTERBERG LIMITS	PERCENT FINES
	LL-PL-PI								
DEPTH									
	<b>SILTY SAND (SM)</b> , fine to coarse grained, brown to dark brown								
					10-16-16	4	114		40
					12-16-24	3	113		23
					10-8-8	3	114		17
					6-8-13	1			2
					22-24-23				
				12-20-23					
	<b>Boring Terminated at 16.5 Feet</b>								

Stratification lines are approximate. In-situ, the transition may be gradual.

Hammer Type: Automatic

Advancement Method:  
8" Hollow Stem Auger

See [Exploration and Testing Procedures](#) for a description of field and laboratory procedures used and additional data (if any).

Notes:

Abandonment Method:  
Boring backfilled with auger cuttings upon completion.

See [Supporting Information](#) for explanation of symbols and abbreviations.

**WATER LEVEL OBSERVATIONS**

Groundwater not encountered



1355 E Cooley Dr, Ste C  
Colton, CA

Boring Started: 11-20-2019

Boring Completed: 11-20-2019

Drill Rig:

Driller: 2R Drilling

Project No.: CB195149

THIS BORING LOG IS NOT VALID IF SEPARATED FROM ORIGINAL REPORT. GEO SMART LOG-NO WELL\_CB195149 PROPOSED COMMERCIAL GPJ TERRACON\_DATATEMPLATE.GDT 11/22/19

# BORING LOG NO. P-1

**PROJECT:** Proposed Commercial and Residential Development

**CLIENT:** Perris at Pentecostal LLC  
Irvine, CA

**SITE:** Perris Boulevard & Santiago Drive  
Moreno Valley

GRAPHIC LOG	LOCATION See <a href="#">Exploration Plan</a> Latitude: 33.8917° Longitude: -117.2265°	DEPTH (Ft)	WATER LEVEL OBSERVATIONS	SAMPLE TYPE	FIELD TEST RESULTS	WATER CONTENT (%)	DRY UNIT WEIGHT (pcf)	ATTERBERG LIMITS LL-PL-PI	PERCENT FINES
DEPTH									
10.0	<b>SILTY SAND (SM)</b> , fine to medium grained, brown	5							47
	<b>Boring Terminated at 10 Feet</b>	10							

Stratification lines are approximate. In-situ, the transition may be gradual.

Hammer Type: Automatic

Advancement Method:  
8" Hollow Stem Auger

See [Exploration and Testing Procedures](#) for a description of field and laboratory procedures used and additional data (if any).

Notes:

Abandonment Method:  
Boring backfilled with Auger Cuttings and Gravel

See [Supporting Information](#) for explanation of symbols and abbreviations.

**WATER LEVEL OBSERVATIONS**  
*Groundwater not encountered*



Boring Started: 11-20-2019

Boring Completed: 11-20-2019

Drill Rig:

Driller: 2R Drilling

Project No.: CB195149

THIS BORING LOG IS NOT VALID IF SEPARATED FROM ORIGINAL REPORT. GEO SMART LOG-NO WELL\_CB195149 PROPOSED COMMERCIAL GPJ TERRACON\_DATATEMPLATE.GDT 11/22/19

# BORING LOG NO. P-2

**PROJECT:** Proposed Commercial and Residential Development

**CLIENT:** Perris at Pentecostal LLC  
Irvine, CA

**SITE:** Perris Boulevard & Santiago Drive  
Moreno Valley

GRAPHIC LOG	LOCATION See <a href="#">Exploration Plan</a> Latitude: 33.8913° Longitude: -117.2265°	DEPTH (Ft.)	WATER LEVEL OBSERVATIONS	SAMPLE TYPE	FIELD TEST RESULTS	WATER CONTENT (%)	DRY UNIT WEIGHT (pcf)	ATTERBERG LIMITS	PERCENT FINES
	LL-PL-PI								
DEPTH									
10.0	<b>SILTY SAND (SM)</b> , fine to medium grained, brown	5							49
	<b>Boring Terminated at 10 Feet</b>	10							
Stratification lines are approximate. In-situ, the transition may be gradual.					Hammer Type: Automatic				

Advancement Method: 8" Hollow Stem Auger	See <a href="#">Exploration and Testing Procedures</a> for a description of field and laboratory procedures used and additional data (if any).  See <a href="#">Supporting Information</a> for explanation of symbols and abbreviations.	Notes:
Abandonment Method: Boring backfilled with Auger Cuttings and Gravel		
<b>WATER LEVEL OBSERVATIONS</b> <i>Groundwater not encountered</i>		
	Boring Started: 11-20-2019 Drill Rig:	Boring Completed: 11-20-2019 Driller: 2R Drilling
	Project No.: CB195149	

THIS BORING LOG IS NOT VALID IF SEPARATED FROM ORIGINAL REPORT. GEO SMART LOG-NO WELL\_CB195149 PROPOSED COMMERCIAL GPJ TERRACON\_DATATEMPLATE.GDT 11/22/19

# BORING LOG NO. P-3

**PROJECT:** Proposed Commercial and Residential Development

**CLIENT:** Perris at Pentecostal LLC  
Irvine, CA

**SITE:** Perris Boulevard & Santiago Drive  
Moreno Valley

GRAPHIC LOG	LOCATION See <a href="#">Exploration Plan</a> Latitude: 33.8909° Longitude: -117.2284°	DEPTH (Ft)	WATER LEVEL OBSERVATIONS	SAMPLE TYPE	FIELD TEST RESULTS	WATER CONTENT (%)	DRY UNIT WEIGHT (pcf)	ATTERBERG LIMITS	PERCENT FINES
	LL-PL-PI								
DEPTH	<b>SILTY SAND (SM)</b> , fine to coarse grained, brown	5							24
10.0	<b>Boring Terminated at 10 Feet</b>	10							

Stratification lines are approximate. In-situ, the transition may be gradual.

Hammer Type: Automatic

Advancement Method: 8" Hollow Stem Auger	See <a href="#">Exploration and Testing Procedures</a> for a description of field and laboratory procedures used and additional data (if any).  See <a href="#">Supporting Information</a> for explanation of symbols and abbreviations.	Notes:
Abandonment Method: Boring backfilled with Auger Cuttings and Gravel		
<b>WATER LEVEL OBSERVATIONS</b> <i>Groundwater not encountered</i>	 <p>1355 E Cooley Dr, Ste C Colton, CA</p>	Boring Started: 11-20-2019 Boring Completed: 11-20-2019  Drill Rig: Driller: 2R Drilling  Project No.: CB195149

THIS BORING LOG IS NOT VALID IF SEPARATED FROM ORIGINAL REPORT. GEO SMART LOG-NO WELL\_CB195149 PROPOSED COMMERCIAL GPJ TERRACON\_DATATEMPLATE.GDT 11/22/19

# BORING LOG NO. P-4

**PROJECT:** Proposed Commercial and Residential Development

**CLIENT:** Perris at Pentecostal LLC  
Irvine, CA

**SITE:** Perris Boulevard & Santiago Drive  
Moreno Valley

GRAPHIC LOG	LOCATION See <a href="#">Exploration Plan</a> Latitude: 33.8909° Longitude: -117.2278°	DEPTH (Ft.)	WATER LEVEL OBSERVATIONS	SAMPLE TYPE	FIELD TEST RESULTS	WATER CONTENT (%)	DRY UNIT WEIGHT (pcf)	ATTERBERG LIMITS	PERCENT FINES
	DEPTH							LL-PL-PI	
5.0	<b>SILTY SAND (SM)</b> , fine to medium grained, brown	5							
	<b>Boring Terminated at 5 Feet</b>								

Stratification lines are approximate. In-situ, the transition may be gradual.

Hammer Type: Automatic

Advancement Method:  
8" Hollow Stem Auger

See [Exploration and Testing Procedures](#) for a description of field and laboratory procedures used and additional data (if any).

Notes:

Abandonment Method:  
Boring backfilled with Auger Cuttings and Gravel

See [Supporting Information](#) for explanation of symbols and abbreviations.

**WATER LEVEL OBSERVATIONS**  
*Groundwater not encountered*



Boring Started: 11-20-2019

Boring Completed: 11-20-2019

Drill Rig:

Driller: 2R Drilling

Project No.: CB195149

THIS BORING LOG IS NOT VALID IF SEPARATED FROM ORIGINAL REPORT. GEO SMART LOG-NO WELL\_CB195149 PROPOSED COMMERCIAL.GPJ TERRACON\_DATATEMPLATE.GDT 11/22/19



# BORING LOG NO. P-5

**PROJECT:** Proposed Commercial and Residential Development

**CLIENT:** Perris at Pentecostal LLC  
Irvine, CA

**SITE:** Perris Boulevard & Santiago Drive  
Moreno Valley

GRAPHIC LOG	LOCATION See <a href="#">Exploration Plan</a> Latitude: 33.8909° Longitude: -117.2271°	DEPTH (Ft.)	WATER LEVEL OBSERVATIONS	SAMPLE TYPE	FIELD TEST RESULTS	WATER CONTENT (%)	DRY UNIT WEIGHT (pcf)	ATTERBERG LIMITS	PERCENT FINES
	LL-PL-PI								
DEPTH									
5.0	<b>SILTY SAND (SM)</b> , fine to medium grained, brown	5							33
	<b>Boring Terminated at 5 Feet</b>								
Stratification lines are approximate. In-situ, the transition may be gradual.					Hammer Type: Automatic				

Advancement Method: 8" Hollow Stem Auger	See <a href="#">Exploration and Testing Procedures</a> for a description of field and laboratory procedures used and additional data (if any).  See <a href="#">Supporting Information</a> for explanation of symbols and abbreviations.	Notes:
Abandonment Method: Boring backfilled with Auger Cuttings and Gravel		
<b>WATER LEVEL OBSERVATIONS</b> <i>Groundwater not encountered</i>	1355 E Cooley Dr, Ste C Colton, CA	Boring Started: 11-20-2019 Boring Completed: 11-20-2019 Drill Rig: Driller: 2R Drilling Project No.: CB195149

THIS BORING LOG IS NOT VALID IF SEPARATED FROM ORIGINAL REPORT. GEO SMART LOG-NO WELL\_CB195149 PROPOSED COMMERCIAL.GPJ TERRACON\_DATATEMPLATE.GDT 11/22/19

# BORING LOG NO. P-6

**PROJECT:** Proposed Commercial and Residential Development

**CLIENT:** Perris at Pentecostal LLC  
Irvine, CA

**SITE:** Perris Boulevard & Santiago Drive  
Moreno Valley

GRAPHIC LOG	LOCATION See <a href="#">Exploration Plan</a> Latitude: 33.8885° Longitude: -117.229°	DEPTH (Ft)	WATER LEVEL OBSERVATIONS	SAMPLE TYPE	FIELD TEST RESULTS	WATER CONTENT (%)	DRY UNIT WEIGHT (pcf)	ATTERBERG LIMITS	PERCENT FINES
	DEPTH							LL-PL-PI	
	<p><b>SILTY SAND (SM)</b>, fine to medium grained, brown</p>	5							
	<p><b>Boring Terminated at 10 Feet</b></p>	10							

Stratification lines are approximate. In-situ, the transition may be gradual.

Hammer Type: Automatic

Advancement Method:  
8" Hollow Stem Auger

See [Exploration and Testing Procedures](#) for a description of field and laboratory procedures used and additional data (if any).

Notes:

Abandonment Method:  
Boring backfilled with Auger Cuttings and Gravel

See [Supporting Information](#) for explanation of symbols and abbreviations.

**WATER LEVEL OBSERVATIONS**  
*Groundwater not encountered*



Boring Started: 11-20-2019

Boring Completed: 11-20-2019

Drill Rig:

Driller: 2R Drilling

Project No.: CB195149

THIS BORING LOG IS NOT VALID IF SEPARATED FROM ORIGINAL REPORT. GEO SMART LOG-NO WELL\_CB195149 PROPOSED COMMERCIAL GPJ TERRACON\_DATATEMPLATE.GDT 11/22/19

# BORING LOG NO. P-7

**PROJECT:** Proposed Commercial and Residential Development

**CLIENT:** Perris at Pentecostal LLC  
Irvine, CA

**SITE:** Perris Boulevard & Santiago Drive  
Moreno Valley

GRAPHIC LOG	LOCATION See <a href="#">Exploration Plan</a> Latitude: 33.8886° Longitude: -117.2286°	DEPTH (Ft.)	WATER LEVEL OBSERVATIONS	SAMPLE TYPE	FIELD TEST RESULTS	WATER CONTENT (%)	DRY UNIT WEIGHT (pcf)	ATTERBERG LIMITS	PERCENT FINES
	DEPTH							LL-PL-PI	
5.0	<b>SILTY SAND (SM)</b> , fine to medium grained, brown	5							
	<b>Boring Terminated at 5 Feet</b>								

Stratification lines are approximate. In-situ, the transition may be gradual.

Hammer Type: Automatic

Advancement Method:  
8" Hollow Stem Auger

See [Exploration and Testing Procedures](#) for a description of field and laboratory procedures used and additional data (if any).

Notes:

Abandonment Method:  
Boring backfilled with Auger Cuttings and Gravel

See [Supporting Information](#) for explanation of symbols and abbreviations.

**WATER LEVEL OBSERVATIONS**  
*Groundwater not encountered*



Boring Started: 11-20-2019

Boring Completed: 11-20-2019

Drill Rig:

Driller: 2R Drilling

Project No.: CB195149

THIS BORING LOG IS NOT VALID IF SEPARATED FROM ORIGINAL REPORT. GEO SMART LOG-NO WELL\_CB195149 PROPOSED COMMERCIAL.GPJ TERRACON\_DATATEMPLATE.GDT 11/22/19

# GRAIN SIZE DISTRIBUTION

ASTM D422 / ASTM C136

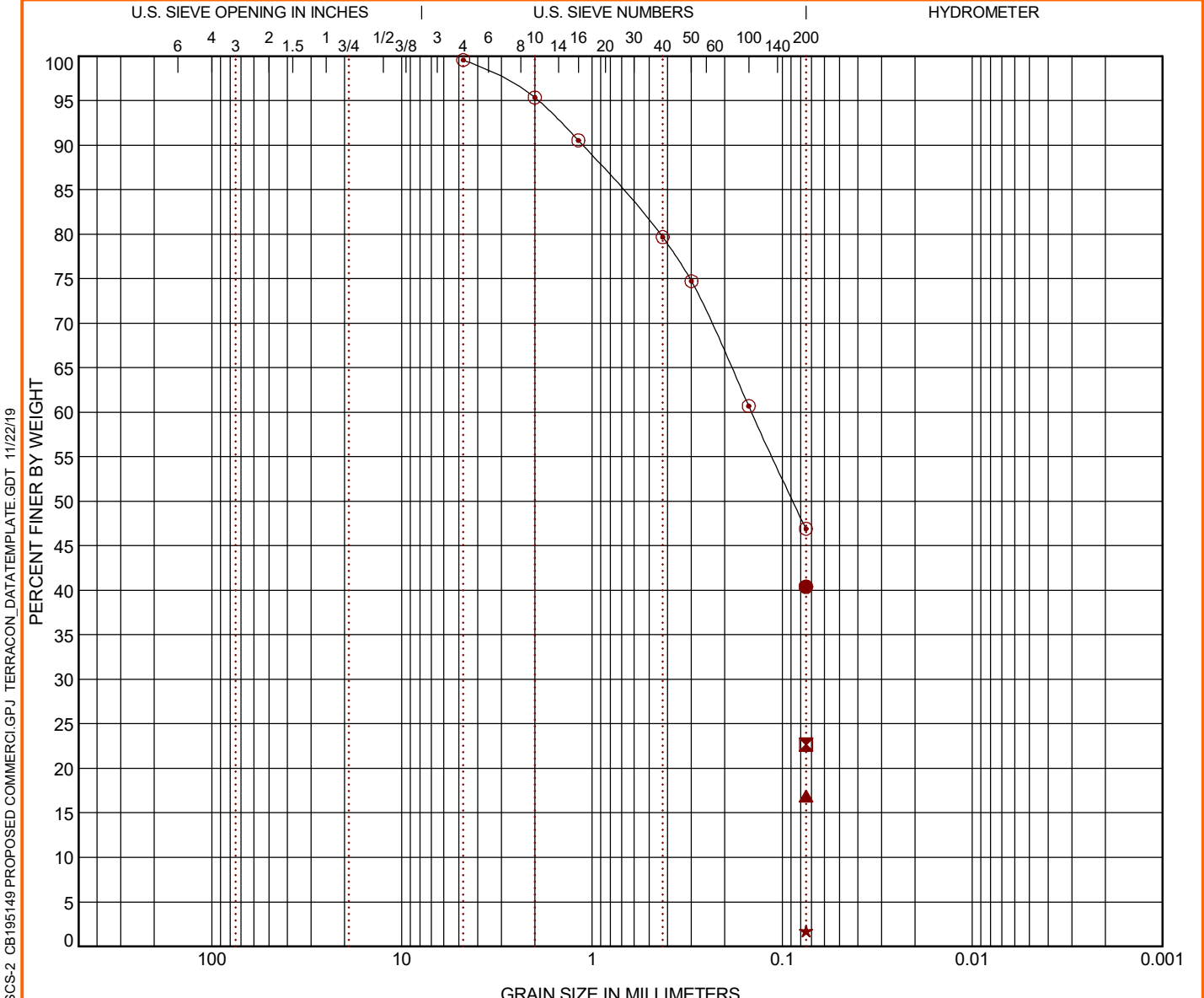

COBBLES	GRAVEL		SAND			SILT OR CLAY
	coarse	fine	coarse	medium	fine	

Boring ID	Depth	USCS Classification	WC (%)	LL	PL	PI	Cc	Cu
● B-2	2.5 - 4		4					
⊠ B-2	5 - 6.5		3					
▲ B-2	7.5 - 9		3					
★ B-2	10 - 11.5		1					
○ P-1	3 - 6							

Boring ID	Depth	D <sub>100</sub>	D <sub>60</sub>	D <sub>30</sub>	D <sub>10</sub>	%Cobbles	%Gravel	%Sand	%Silt	%Fines	%Clay
● B-2	2.5 - 4	0.075								40.4	
⊠ B-2	5 - 6.5	0.075								22.7	
▲ B-2	7.5 - 9	0.075								16.9	
★ B-2	10 - 11.5	0.075								1.7	
○ P-1	3 - 6	4.75	0.145					52.7		46.9	

PROJECT: Proposed Commercial and Residential Development  SITE: Perris Boulevard & Santiago Drive Moreno Valley	1355 E Cooley Dr, Ste C Colton, CA	PROJECT NUMBER: CB195149  CLIENT: Perris at Pentecostal LLC Irvine, CA
--	---------------------------------------	---

LABORATORY TESTS ARE NOT VALID IF SEPARATED FROM ORIGINAL REPORT. GRAIN SIZE: USCS-2 CB195149 PROPOSED COMMERCIAL.GPJ TERRACON\_DATATEMPLATE.GDT 11/22/19

# GRAIN SIZE DISTRIBUTION

ASTM D422 / ASTM C136

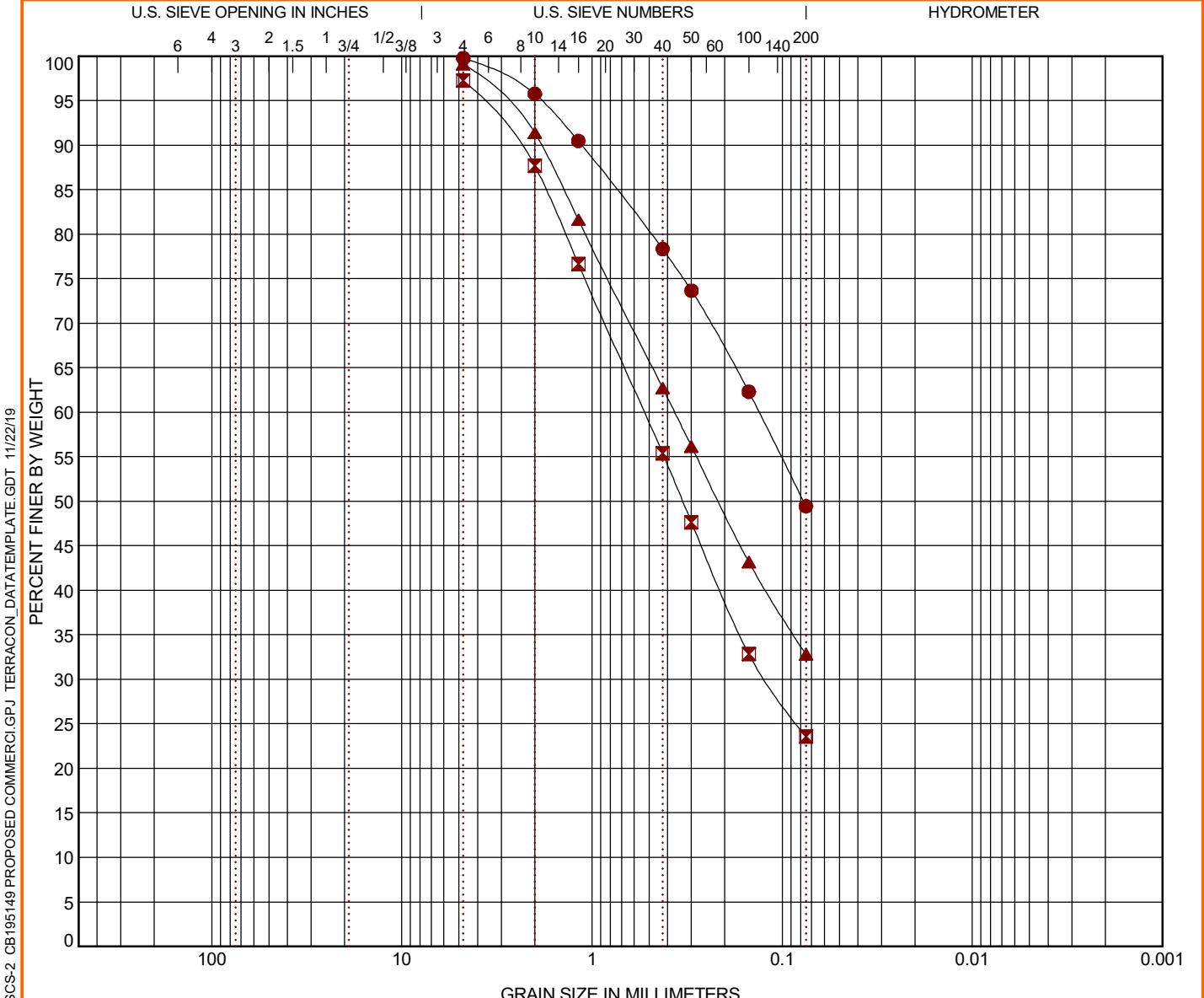

COBBLES	GRAVEL		SAND			SILT OR CLAY
	coarse	fine	coarse	medium	fine	

LABORATORY TESTS ARE NOT VALID IF SEPARATED FROM ORIGINAL REPORT. GRAIN SIZE: USCS-2 CB195149 PROPOSED COMMERCIAL.GPJ TERRACON\_DATATEMPLATE.GDT 11/22/19

Boring ID	Depth	USCS Classification	WC (%)	LL	PL	PI	Cc	Cu
● P-2	3 - 6							
☒ P-3	6 - 10							
▲ P-5	0 - 3							

Boring ID	Depth	D <sub>100</sub>	D <sub>60</sub>	D <sub>30</sub>	D <sub>10</sub>	%Cobbles	%Gravel	%Sand	%Silt	%Fines	%Clay
● P-2	3 - 6	4.75	0.132					50.3		49.4	
☒ P-3	6 - 10	4.75	0.531	0.121				73.7		23.6	
▲ P-5	0 - 3	4.75	0.368					66.3		32.8	

PROJECT: Proposed Commercial and Residential Development	1355 E Cooley Dr, Ste C Colton, CA	PROJECT NUMBER: CB195149
SITE: Perris Boulevard & Santiago Drive Moreno Valley		CLIENT: Perris at Pentecostal LLC Irvine, CA

### PERCOLATION TEST DATA

BORING NUMBER: P-1  
 LOT No: N/A  
 TRACT No: N/A

CLIENT: [REDACTED]  
 PROJECT: Proposed Commercial and Residential Development

DATE OF DRILLING: November 18, 2019      DEPTH BEFORE (ft.): 9.4  
 DATE OF TESTING: November 18, 2019      DEPTH AFTER (ft.): 9.4  
 DRILLED BY: MS      PVC PIPE DIA. (in.): 3.0  
 TESTED BY: MS      PERC HOLE DIA. (in.): 9.0

Time Interval (min.)	Total Elapsed Time (min.)	Initial Water Level (ft.)	Final Water Level (ft.)	Change in Water Level (ft.)	Initial Hole Depth (ft.)	Final Hole Depth (ft.)	Percolation Rate (in/hr)	Infiltration rate (Porchet Method) (in/hr)
25	25	5.00	6.50	1.50	9.4	9.4	43.20	2.1
25	50	4.80	7.30	2.50	9.4	9.4	72.00	3.8
10	60	5.80	6.70	0.90	9.4	9.4	64.80	3.6
10	70	5.40	6.05	0.65	9.4	9.4	46.80	2.3
10	80	5.15	5.90	0.75	9.4	9.4	54.00	2.5
10	90	4.55	5.40	0.85	9.4	9.4	61.20	2.5
10	100	4.80	5.55	0.75	9.4	9.4	54.00	2.3
10	110	4.75	5.55	0.80	9.4	9.4	57.60	2.4

Average of last 3 readings: 57.60      2.41

### PERCOLATION TEST DATA

BORING NUMBER: P-2  
 LOT No: N/A  
 TRACT No: N/A

CLIENT: [REDACTED]  
 PROJECT: Proposed Commercial and Residential Development

DATE OF DRILLING: November 18, 2019      DEPTH BEFORE (ft.): 9.7  
 DATE OF TESTING: November 18, 2019      DEPTH AFTER (ft.): 9.7  
 DRILLED BY: MS      PVC PIPE DIA. (in.): 3.0  
 TESTED BY: MS      PERC HOLE DIA. (in.): 9.0

Time Interval (min.)	Total Elapsed Time (min.)	Initial Water Level (ft.)	Final Water Level (ft.)	Change in Water Level (ft.)	Initial Hole Depth (ft.)	Final Hole Depth (ft.)	Percolation Rate (in/hr)	Infiltration rate (Porchet Method) (in/hr)
25	25	5.00	7.40	2.40	9.7	9.7	69.12	3.5
25	50	4.70	7.30	2.60	9.7	9.7	74.88	3.6
10	60	5.00	6.30	1.30	9.7	9.7	93.60	4.1
10	70	4.80	6.00	1.20	9.7	9.7	86.40	3.6
10	80	4.70	6.00	1.30	9.7	9.7	93.60	3.9
10	90	4.90	5.90	1.00	9.7	9.7	72.00	3.0
10	100	4.75	5.70	0.95	9.7	9.7	68.40	2.8
10	110	5.00	5.95	0.95	9.7	9.7	68.40	2.9

Average of last 3 readings: 69.60      2.89

### PERCOLATION TEST DATA

BORING NUMBER: P-3  
 LOT No: N/A  
 TRACT No: N/A

CLIENT: [REDACTED]  
 PROJECT: Proposed Commercial and Residential Development

DATE OF DRILLING: November 18, 2019      DEPTH BEFORE (ft.): 9.7  
 DATE OF TESTING: November 18, 2019      DEPTH AFTER (ft.): 9.7  
 DRILLED BY: MS      PVC PIPE DIA. (in.): 3.0  
 TESTED BY: MS      PERC HOLE DIA. (in.): 9.0

Time Interval (min.)	Total Elapsed Time (min.)	Initial Water Level (ft.)	Final Water Level (ft.)	Change in Water Level (ft.)	Initial Hole Depth (ft.)	Final Hole Depth (ft.)	Percolation Rate (in/hr)	Infiltration rate (Porchet Method) (in/hr)
25	25	5.00	9.70	4.70	9.7	9.7	135.36	10.0
25	50	4.70	9.70	5.00	9.7	9.7	144.00	10.0
10	60	5.20	7.85	2.65	9.7	9.7	190.80	10.6
10	70	4.95	7.40	2.45	9.7	9.7	176.40	8.9
10	80	4.75	7.55	2.80	9.7	9.7	201.60	10.1
10	90	5.15	7.52	2.37	9.7	9.7	170.64	9.0
10	100	5.07	7.37	2.30	9.7	9.7	165.60	8.5
10	110	5.00	7.30	2.30	9.7	9.7	165.60	8.3

Average of last 3 readings: **167.28**      **8.59**



### PERCOLATION TEST DATA

BORING NUMBER: P-4  
 LOT No: N/A  
 TRACT No: N/A

CLIENT: [REDACTED]  
 PROJECT: Proposed Commercial and Residential Development

DATE OF DRILLING: November 18, 2019      DEPTH BEFORE (ft.): 4.7  
 DATE OF TESTING: November 18, 2019      DEPTH AFTER (ft.): 4.7  
 DRILLED BY: MS      PVC PIPE DIA. (in.): 3.0  
 TESTED BY: MS      PERC HOLE DIA. (in.): 9.0

Time Interval (min.)	Total Elapsed Time (min.)	Initial Water Level (ft.)	Final Water Level (ft.)	Change in Water Level (ft.)	Initial Hole Depth (ft.)	Final Hole Depth (ft.)	Percolation Rate (in/hr)	Infiltration rate (Porchet Method) (in/hr)
25	25	0.00	4.70	4.70	4.7	4.7	135.36	10.0
25	50	0.00	4.30	4.30	4.7	4.7	123.84	8.5
10	60	0.00	2.70	2.70	4.7	4.7	194.40	10.3
10	70	0.00	2.40	2.40	4.7	4.7	172.80	8.8
10	80	0.00	2.40	2.40	4.7	4.7	172.80	8.8
10	90	0.00	2.40	2.40	4.7	4.7	172.80	8.8
10	100	0.00	2.40	2.40	4.7	4.7	172.80	8.8
10	110	0.00	2.30	2.30	4.7	4.7	165.60	8.3

Average of last 3 readings:      170.40      8.63

### PERCOLATION TEST DATA

BORING NUMBER: P-5  
 LOT No: N/A  
 TRACT No: N/A

CLIENT:   
 PROJECT: Proposed Commercial and Residential Development

DATE OF DRILLING: November 18, 2019      DEPTH BEFORE (ft.): 4.6  
 DATE OF TESTING: November 18, 2019      DEPTH AFTER (ft.): 4.6  
 DRILLED BY: MS      PVC PIPE DIA. (in.): 3.0  
 TESTED BY: MS      PERC HOLE DIA. (in.): 9.0

Time Interval (min.)	Total Elapsed Time (min.)	Initial Water Level (ft.)	Final Water Level (ft.)	Change in Water Level (ft.)	Initial Hole Depth (ft.)	Final Hole Depth (ft.)	Percolation Rate (in/hr)	Infiltration rate (Porchet Method) (in/hr)
25	25	0.00	4.60	4.60	4.6	4.6	132.48	10.0
25	50	0.00	4.60	4.60	4.6	4.6	132.48	10.0
10	60	0.00	1.50	1.50	4.6	4.6	108.00	5.0
10	70	0.00	1.50	1.50	4.6	4.6	108.00	5.0
10	80	0.00	1.60	1.60	4.6	4.6	115.20	5.4
10	90	0.00	1.70	1.70	4.6	4.6	122.40	5.8
10	100	0.00	1.40	1.40	4.6	4.6	100.80	4.6
10	110	0.00	1.50	1.50	4.6	4.6	108.00	5.0
10	120	0.00	1.50	1.50	4.6	4.6	108.00	5.0

Average of last 3 readings: 105.60      4.88

### PERCOLATION TEST DATA

BORING NUMBER: P-6  
 LOT No: N/A  
 TRACT No: N/A

CLIENT: [REDACTED]  
 PROJECT: Proposed Commercial and Residential Development

DATE OF DRILLING: November 18, 2019      DEPTH BEFORE (ft.): 9.5  
 DATE OF TESTING: November 18, 2019      DEPTH AFTER (ft.): 9.5  
 DRILLED BY: MS      PVC PIPE DIA. (in.): 3.0  
 TESTED BY: MS      PERC HOLE DIA. (in.): 9.0

Time Interval (min.)	Total Elapsed Time (min.)	Initial Water Level (ft.)	Final Water Level (ft.)	Change in Water Level (ft.)	Initial Hole Depth (ft.)	Final Hole Depth (ft.)	Percolation Rate (in/hr)	Infiltration rate (Porchet Method) (in/hr)
25	25	5.00	7.40	2.40	9.5	9.5	69.12	3.7
25	50	5.00	7.10	2.10	9.5	9.5	60.48	3.1
10	60	5.10	6.75	1.65	9.5	9.5	118.80	5.9
10	70	4.90	6.60	1.70	9.5	9.5	122.40	5.8
10	80	4.70	6.45	1.75	9.5	9.5	126.00	5.7
10	90	4.30	6.35	2.05	9.5	9.5	147.60	6.3
10	100	4.85	6.40	1.55	9.5	9.5	111.60	5.2
10	110	4.50	6.31	1.81	9.5	9.5	130.32	5.7
10	120	5.05	6.40	1.35	9.5	9.5	97.20	4.6
10	130	4.80	6.30	1.50	9.5	9.5	108.00	4.9
10	140	4.80	6.27	1.47	9.5	9.5	105.84	4.8

Average of last 3 readings: 103.68 4.76

### PERCOLATION TEST DATA

BORING NUMBER: P-7  
 LOT No: N/A  
 TRACT No: N/A

CLIENT: [REDACTED]  
 PROJECT: Proposed Commercial and Residential Development

DATE OF DRILLING: November 18, 2019      DEPTH BEFORE (ft.): 5.0  
 DATE OF TESTING: November 18, 2019      DEPTH AFTER (ft.): 5.0  
 DRILLED BY: MS      PVC PIPE DIA. (in.): 3.0  
 TESTED BY: MS      PERC HOLE DIA. (in.): 9.0

Time Interval (min.)	Total Elapsed Time (min.)	Initial Water Level (ft.)	Final Water Level (ft.)	Change in Water Level (ft.)	Initial Hole Depth (ft.)	Final Hole Depth (ft.)	Percolation Rate (in/hr)	Infiltration rate (Porchet Method) (in/hr)
25	25	0.00	5.00	5.00	5.0	5.0	144.00	10.0
25	50	0.00	5.00	5.00	5.0	5.0	144.00	10.0
10	60	0.00	5.00	5.00	5.0	5.0	360.00	25.1
10	70	0.00	5.00	5.00	5.0	5.0	360.00	25.1
10	80	0.00	5.00	5.00	5.0	5.0	360.00	25.1
10	90	0.00	5.00	5.00	5.0	5.0	360.00	25.1
10	100	0.00	4.80	4.80	5.0	5.0	345.60	23.2
10	110	0.00	4.70	4.70	5.0	5.0	338.40	22.4

Average of last 3 readings:      348.00      23.57

Criteria for Assigning Group Symbols and Group Names Using Laboratory Tests <sup>A</sup>				Soil Classification		
				Group Symbol	Group Name <sup>B</sup>	
<b>Coarse-Grained Soils:</b> More than 50% retained on No. 200 sieve	<b>Gravels:</b> More than 50% of coarse fraction retained on No. 4 sieve	<b>Clean Gravels:</b> Less than 5% fines <sup>C</sup>	$Cu \geq 4$ and $1 \leq Cc \leq 3$ <sup>E</sup>	GW	Well-graded gravel <sup>F</sup>	
			$Cu < 4$ and/or $[Cc < 1 \text{ or } Cc > 3.0]$ <sup>E</sup>	GP	Poorly graded gravel <sup>F</sup>	
		<b>Gravels with Fines:</b> More than 12% fines <sup>C</sup>	Fines classify as ML or MH	GM	Silty gravel <sup>F, G, H</sup>	
			Fines classify as CL or CH	GC	Clayey gravel <sup>F, G, H</sup>	
	<b>Sands:</b> 50% or more of coarse fraction passes No. 4 sieve	<b>Clean Sands:</b> Less than 5% fines <sup>D</sup>	$Cu \geq 6$ and $1 \leq Cc \leq 3$ <sup>E</sup>	SW	Well-graded sand <sup>I</sup>	
			$Cu < 6$ and/or $[Cc < 1 \text{ or } Cc > 3.0]$ <sup>E</sup>	SP	Poorly graded sand <sup>I</sup>	
		<b>Sands with Fines:</b> More than 12% fines <sup>D</sup>	Fines classify as ML or MH	SM	Silty sand <sup>G, H, I</sup>	
			Fines classify as CL or CH	SC	Clayey sand <sup>G, H, I</sup>	
<b>Fine-Grained Soils:</b> 50% or more passes the No. 200 sieve	<b>Silts and Clays:</b> Liquid limit less than 50	<b>Inorganic:</b>	$PI > 7$ and plots on or above "A" line	CL	Lean clay <sup>K, L, M</sup>	
			$PI < 4$ or plots below "A" line <sup>J</sup>	ML	Silt <sup>K, L, M</sup>	
		<b>Organic:</b>	Liquid limit - oven dried	< 0.75	OL	Organic clay <sup>K, L, M, N</sup>
			Liquid limit - not dried			Organic silt <sup>K, L, M, O</sup>
	<b>Silts and Clays:</b> Liquid limit 50 or more	<b>Inorganic:</b>	$PI$ plots on or above "A" line	CH	Fat clay <sup>K, L, M</sup>	
			$PI$ plots below "A" line	MH	Elastic Silt <sup>K, L, M</sup>	
		<b>Organic:</b>	Liquid limit - oven dried	< 0.75	OH	Organic clay <sup>K, L, M, P</sup>
			Liquid limit - not dried			Organic silt <sup>K, L, M, Q</sup>
<b>Highly organic soils:</b>	Primarily organic matter, dark in color, and organic odor			PT	Peat	

<sup>A</sup> Based on the material passing the 3-inch (75-mm) sieve.

<sup>B</sup> If field sample contained cobbles or boulders, or both, add "with cobbles or boulders, or both" to group name.

<sup>C</sup> Gravels with 5 to 12% fines require dual symbols: GW-GM well-graded gravel with silt, GW-GC well-graded gravel with clay, GP-GM poorly graded gravel with silt, GP-GC poorly graded gravel with clay.

<sup>D</sup> Sands with 5 to 12% fines require dual symbols: SW-SM well-graded sand with silt, SW-SC well-graded sand with clay, SP-SM poorly graded sand with silt, SP-SC poorly graded sand with clay.

$$Cu = D_{60}/D_{10} \quad Cc = \frac{(D_{30})^2}{D_{10} \times D_{60}}$$

<sup>F</sup> If soil contains <sup>3</sup> 15% sand, add "with sand" to group name.

<sup>G</sup> If fines classify as CL-ML, use dual symbol GC-GM, or SC-SM.

<sup>H</sup> If fines are organic, add "with organic fines" to group name.

<sup>I</sup> If soil contains <sup>3</sup> 15% gravel, add "with gravel" to group name.

<sup>J</sup> If Atterberg limits plot in shaded area, soil is a CL-ML, silty clay.

<sup>K</sup> If soil contains 15 to 29% plus No. 200, add "with sand" or "with gravel," whichever is predominant.

<sup>L</sup> If soil contains <sup>3</sup> 30% plus No. 200 predominantly sand, add "sandy" to group name.

<sup>M</sup> If soil contains <sup>3</sup> 30% plus No. 200, predominantly gravel, add "gravelly" to group name.

<sup>N</sup>  $PI \geq 4$  and plots on or above "A" line.

<sup>O</sup>  $PI < 4$  or plots below "A" line.

<sup>P</sup>  $PI$  plots on or above "A" line.



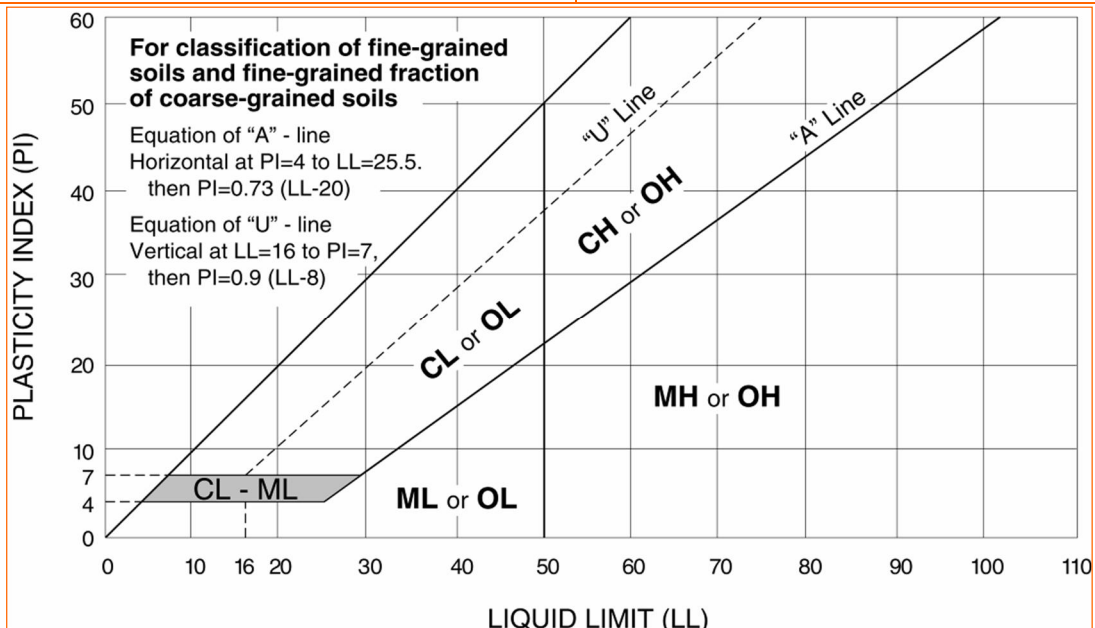

<sup>Q</sup>  $PI$  plots below "A" line.



# GENERAL NOTES

## DESCRIPTION OF SYMBOLS AND ABBREVIATIONS

Proposed Commercial and Residential Development ■ Moreno Valley,  
November 26, 2019 ■ Terracon Project No. CB195149

SAMPLING	WATER LEVEL	FIELD TESTS
 Auger Cuttings  Modified California Ring Sampler	 Water Initially Encountered  Water Level After a Specified Period of Time  Water Level After a Specified Period of Time  Water levels indicated on the soil boring logs are the levels measured in the borehole at the times indicated. Groundwater level variations will occur over time. In low permeability soils, accurate determination of groundwater levels is not possible with short term water level observations.	(N) Standard Penetration Test Resistance (Blows/Ft.) (HP) Hand Penetrometer (T) Torvane (DCP) Dynamic Cone Penetrometer (UC) Unconfined Compressive Strength (PID) Photo-Ionization Detector (OVA) Organic Vapor Analyzer

### DESCRIPTIVE SOIL CLASSIFICATION

Soil classification is based on the Unified Soil Classification System. Coarse Grained Soils have more than 50% of their dry weight retained on a #200 sieve; their principal descriptors are: boulders, cobbles, gravel or sand. Fine Grained Soils have less than 50% of their dry weight retained on a #200 sieve; they are principally described as clays if they are plastic, and silts if they are slightly plastic or non-plastic. Major constituents may be added as modifiers and minor constituents may be added according to the relative proportions based on grain size. In addition to gradation, coarse-grained soils are defined on the basis of their in-place relative density and fine-grained soils on the basis of their consistency.

### LOCATION AND ELEVATION NOTES

Unless otherwise noted, Latitude and Longitude are approximately determined using a hand-held GPS device. The accuracy of such devices is variable. Surface elevation data annotated with +/- indicates that no actual topographical survey was conducted to confirm the surface elevation. Instead, the surface elevation was approximately determined from topographic maps of the area.

### STRENGTH TERMS

RELATIVE DENSITY OF COARSE-GRAINED SOILS (More than 50% retained on No. 200 sieve.) Density determined by Standard Penetration Resistance			CONSISTENCY OF FINE-GRAINED SOILS (50% or more passing the No. 200 sieve.) Consistency determined by laboratory shear strength testing, field visual-manual procedures or standard penetration resistance			
Descriptive Term (Density)	Standard Penetration or N-Value Blows/Ft.	Ring Sampler Blows/Ft.	Descriptive Term (Consistency)	Unconfined Compressive Strength Qu, (tsf)	Standard Penetration or N-Value Blows/Ft.	Ring Sampler Blows/Ft.
Very Loose	0 - 3	0 - 6	Very Soft	less than 0.25	0 - 1	< 3
Loose	4 - 9	7 - 18	Soft	0.25 to 0.50	2 - 4	3 - 4
Medium Dense	10 - 29	19 - 58	Medium Stiff	0.50 to 1.00	4 - 8	5 - 9
Dense	30 - 50	59 - 98	Stiff	1.00 to 2.00	8 - 15	10 - 18
Very Dense	> 50	> 99	Very Stiff	2.00 to 4.00	15 - 30	19 - 42
			Hard	> 4.00	> 30	> 42

RELATIVE PROPORTIONS OF SAND AND GRAVEL		RELATIVE PROPORTIONS OF FINES	
Descriptive Term(s) of other constituents	Percent of Dry Weight	Descriptive Term(s) of other constituents	Percent of Dry Weight
Trace	<15	Trace	<5
With	15-29	With	5-12
Modifier	>30	Modifier	>12

GRAIN SIZE TERMINOLOGY		PLASTICITY DESCRIPTION	
Major Component of Sample	Particle Size	Term	Plasticity Index
Boulders	Over 12 in. (300 mm)	Non-plastic	0
Cobbles	12 in. to 3 in. (300mm to 75mm)	Low	1 - 10
Gravel	3 in. to #4 sieve (75mm to 4.75 mm)	Medium	11 - 30
Sand	#4 to #200 sieve (4.75mm to 0.075mm)	High	> 30
Silt or Clay	Passing #200 sieve (0.075mm)		



# Geotechnical Engineering Report

---

**Proposed Residential Development  
Moreno Valley, Riverside County, California**

November 29, 2021

Terracon Project No. CB205038

**Prepared for:**

Perris at Pentecostal, LLC  
Irvine, California

**Prepared by:**

Terracon Consultants, Inc.  
Colton, California



November 29, 2021

Perris at Pentecostal, LLC  
41 Corporate Park  
Irvine, California 92606



Attn: Mr. David Patton  
P: (949) 296 0450  
E: dpatton545@gmail.com

Re: Geotechnical Engineering Report  
Proposed Residential Development  
Northeast Corner of Iris Avenue and Emma Lane  
Moreno Valley, Riverside County, California  
Terracon Project No. CB205038

Dear Mr. Patton:

We have completed the Geotechnical Engineering services for the above referenced project. This study was performed in general accordance with the Terracon Proposal No. PCB205038 dated March 17, 2020, and authorized September 24, 2021. This report presents the findings of the subsurface exploration and provides geotechnical recommendations concerning earthwork and the design and construction of foundations, floor slabs and pavements for the proposed project.

We appreciate the opportunity to be of service to you on this project. If you have any questions concerning this report or if we may be of further service, please contact us.

Sincerely,  
**Terracon Consultants, Inc.**

Jay J. Martin, E.G.  
Principal Geologist

Keith P. Askew, P.E., G.E.  
Department Manager



## REPORT TOPICS

INTRODUCTION.....	1
SITE CONDITIONS.....	1
PROJECT DESCRIPTION.....	2
GEOTECHNICAL CHARACTERIZATION.....	3
SEISMIC CONSIDERATIONS.....	5
LIQUEFACTION AND SEISMIC SETTLEMENT.....	6
GEOTECHNICAL OVERVIEW.....	7
EARTHWORK.....	8
SHALLOW FOUNDATIONS.....	13
FLOOR SLABS.....	15
PAVEMENTS.....	16
CORROSIVITY.....	19
GENERAL COMMENTS.....	19

Note: This report was originally delivered in a web-based format. **Orange Bold** text in the report indicates a referenced section heading. The PDF version also includes hyperlinks which direct the reader to that section and clicking on the [GeoReport](#) logo will bring you back to this page. For more interactive features, please view your project online at [client.terracon.com](http://client.terracon.com).

## ATTACHMENTS

**EXPLORATION AND TESTING PROCEDURES**  
**SITE LOCATION AND EXPLORATION PLANS**  
**EXPLORATION RESULTS**  
**SUPPORTING INFORMATION**

**Note:** Refer to each individual Attachment for a listing of contents.

**Geotechnical Engineering Report**  
**Proposed Residential Development**  
**Northeast Corner of Iris Avenue and Emma Lane**  
**Moreno Valley, Riverside County, California**  
**Terracon Project No. CB205038**  
**November 29, 2021**

## **INTRODUCTION**

This report presents the results of our subsurface exploration and geotechnical engineering services performed for the proposed Residential Development to be located at the Northeast Corner of Iris Avenue and Emma Lane in Moreno Valley, Riverside County, California. The purpose of these services is to provide information and geotechnical engineering recommendations relative to:

- Subsurface soil conditions
- Groundwater conditions and historic high groundwater
- 2019 California Building Code (CBC) seismic design parameters
- Seismic settlement
- Subgrade preparation/earthwork recommendations
- Foundation design and concrete slabs-on-grade
- Design for preliminary pavement sections

The geotechnical engineering Scope of Services for this project included the advancement of eighteen test borings to depths ranging from approximately 21½ to 51½ feet below existing site grades and laboratory testing. Our scope also included conducting seven Cone Penetrometer Test (CPT) soundings to depths of approximately 50 to 100 feet below existing ground surface (bgs), and preparation of this report.

Maps showing the site and boring locations are shown in the **Site Location** and **Exploration Plan** sections, respectively. The results of the laboratory testing performed on soil samples obtained from the site during the field exploration are included on the boring logs and/or as separate graphs in the **Exploration Results** section.

## **SITE CONDITIONS**

The following description of site conditions is derived from our site visit in association with the field exploration and our review of publicly available geologic and topographic maps.

Item	Description
<b>Parcel Information</b>	<p>The project site is an approximately 20-acre tract of land located at the Northeast Corner of Iris Avenue and Emma Lane in Moreno Valley, Riverside County, California.</p> <p>The approximate coordinates of the site are: 33.8906°N/117.2288°W See <b>Site Location</b></p>
<b>Existing Improvements</b>	<p>The project site is generally an undeveloped vacant parcel of land; however, there is an abandoned commercial complex that is partially demolished in the northwest corner, a residence located off of Emma Lane, and a residence with horse stables/arena along the southern boundary. The property overall is bounded by the following improvements:</p> <p>West side: March Middle and Rainbow Ridge Elementary Schools North side: Vacant undeveloped land East side: Home Depot and a utility easement South side: Residential development</p>
<b>Background</b>	<p>Terracon Consultants previously prepared a Geotechnical Report for Perris at Pentecostal for this project site providing on-site infiltration rates based on percolation testing. A report for that study was issued on November 26, 2019 (Terracon project number CB195149).</p>
<b>Current Ground Cover</b>	<p>With the exception of the improvements detailed above, the site is covered with native soils and grass.</p>
<b>Existing Topography</b>	<p>The project site is relatively level with elevations generally ranging from 1,510 feet to 1,505 feet based on Google Earth imagery.</p>

## PROJECT DESCRIPTION

Our initial understanding of the project was provided in our proposal and was discussed during project planning. A period of collaboration has transpired since the project was initiated, and our final understanding of the project conditions is as follows:

Item	Description
<b>Proposed Development</b>	<p>A site plan was provided for our use dated February 28, 2020, prepared by Humphreys &amp; Partners Architects, L.P. The proposed construction includes eighteen 2-story Big House Buildings, three 3-story E-Urban Buildings and one Club/Leasing Building with a combined gross building area of approximately 592,037 SF (square feet). The project will also include appurtenant infrastructure, utilities, parking, and driveways. A total of approximately 830 parking spaces will be provided, of which approximately 340 will be covered with carports. The development will also include on-site stormwater infiltration basins. We understand that percolation tests conducted during the previous study for this project site will be utilized for infiltration rates.</p>

Item	Description
<b>Proposed Structures</b>	Eighteen 2-storey Big House Buildings, three 3-storey E-Urban Buildings and one Club/Leasing building with a combined gross building area of approximately 592,037 SF (square feet).
<b>Building Construction</b>	The proposed buildings will consist of wood-frame structures supported on a conventional shallow foundation system with slabs on grade.
<b>Finished Floor Elevation</b>	Anticipated to be within 3 feet of existing grade.
<b>Structural Loads</b> (assumed)	Structural loads were not provided at the time of this report. We assume that the proposed structures will have the following loads: <ul style="list-style-type: none"> <li>■ Columns: up to 200 kips</li> <li>■ Walls: 1 to 4 kips per linear foot (klf)</li> <li>■ Slabs: 100 to 150 pounds per square foot (psf)</li> </ul>
<b>Grading Requirements</b>	Grading plans were not provided; we assume cuts and fills for grading will be less than 3 feet excluding remedial grading requirements. Slopes are anticipated to have inclinations of 2:1 (horizontal:vertical) and maximum heights of 5 feet.
<b>Below Grade Structures</b>	Not anticipated
<b>Infiltration Systems</b>	An on-site stormwater retention/infiltration system is planned and may consist of either a basin or chamber.
<b>Free-Standing Retaining Wall</b>	Not anticipated
<b>Pavements</b>	Paved driveway and parking will be constructed on site. We assume both rigid (concrete) and flexible (asphalt) pavement sections will be considered with the following loadings. Anticipated traffic indices (TIs) are as follows for asphalt pavement: <ul style="list-style-type: none"> <li>■ Auto Parking Areas: TI=4.5</li> <li>■ Drive Lanes: TI=5.5</li> <li>■ Truck Delivery Areas: TI=6.0</li> <li>■ The pavement design period is 20 years.</li> </ul> Anticipated average daily truck traffic (ADTT) is as follows for concrete pavement: <ul style="list-style-type: none"> <li>■ Light Duty: ADTT=1 (Category A)</li> <li>■ Medium Duty: ADTT=25 (Category B)</li> <li>■ Dumpster Pad: ADTT=700 (Category C)</li> </ul>

## GEOTECHNICAL CHARACTERIZATION

### Site Geology

The site is located in the northern portion of the Perris Block, part of the Peninsular Ranges Geomorphic Province. The northern Perris Block is bounded on the southwest by the Chino-Elsinore fault, on the north by the Cucamonga fault, and on the northeast by the San Jacinto fault. The Perris Block is largely underlain by granitic rocks of the Peninsular Ranges batholith. These rocks consist mostly of varied granitic types such as exist in the Lakeview Mountains, east of the site.

Morton and others (2002, [https://ngmdb.usgs.gov/Prodesc/proddesc\\_464845.htm](https://ngmdb.usgs.gov/Prodesc/proddesc_464845.htm)) mapped most of the site as young alluvial fan deposits of Holocene and Pleistocene age. The northeast portion of the site is mapped as very old alluvial fan deposits of early Pleistocene age (Morton and others, 2002). As part of a relatively stable structural block, these older materials have been subjected to a long period of subaerial exposure (at least 25,000 years). The in-situ weathering of the alluvium has resulted in a strong reddish-brown color and elevated clay content associated with argillic soil horizons.

### **Subsurface Profile**

We have developed a general characterization of the subsurface conditions based upon our review of the subsurface exploration, laboratory data, geologic setting and our understanding of the project. In general, the site is underlain with interbedded layers of silty sand, sandy lean clay, lean clay, and poorly graded sand with varying amounts of silt. The soils encountered in the borings within the upper approximately 4 to 15 feet bgs were generally comprised of loose, silty sand and poorly graded sand with varying amount of silt. Layers of lean clay with varying amounts of sand were encountered at varying depths generally greater than 13 feet bgs with the exception of B-18 where it was encountered at 4 feet bgs.

The geotechnical characterization forms the basis of our geotechnical calculations and evaluation of site preparation, foundation options, and pavement options. As noted in **General Comments**, the characterization is based upon widely spaced exploration points across the site, and variations are likely.

Conditions encountered at each exploration point are indicated on the individual logs. The individual logs can be found in the **Exploration Results** section of this report. Stratification boundaries on the boring logs represent the approximate location of changes in native soil types; in situ, the transition between materials may be gradual.

### **Groundwater Conditions**

The borings were advanced using continuous flight auger drilling techniques that allow short-term groundwater observations to be made while drilling. Groundwater was observed within borings B-1, B-3 and B-13 at depths of 46½, 36½, and 39½ feet bgs respectively, during the course of drilling. Our review of historical information regarding groundwater levels for the area indicates that high historical groundwater levels are about 20 feet bgs. Groundwater level fluctuations occur due to seasonal variations in the amount of rainfall, runoff and other factors not evident at the time the borings were performed.

### **Hydroconsolidation**

To evaluate the potential deformation that may be caused by the addition of water to subsurface soils, hydroconsolidation testing was performed on four relatively undisturbed samples. The results are shown in Exploration Results section. The test results indicate collapse potentials of

1.9% (B-2 at 5 feet), 2.8% (B-6 at 5 feet), 1.7% (B-13 at 5 feet), and 0.4% (B-15 at 7.5 feet). The soil samples were saturated under a confining pressure of 2,000 psf. The risk of hydrocollapse can be reduced by the removal and recompaction of the upper zones of the existing soils within the building pads footprints as recommended in this report.

## SEISMIC CONSIDERATIONS

Based on the soil properties encountered at the site and as described on the exploration logs and results, it is our opinion that the Seismic Site Classification is D. The 2019 California Building Code (CBC) Seismic Design Parameters have been generated using the SEAOC/OSHPD Seismic Design Maps Tool. This web-based software application calculates seismic design parameters in accordance with ASCE 7-16 and 2019 CBC. The 2019 CBC requires that a site-specific ground motion study be performed in accordance with Section 11.4.8 of ASCE 7-16 for Site Class D sites with a mapped  $S_1$  value greater than or equal 0.2.

However, Section 11.4.8 of ASCE 7-16 includes an exception from such analysis for specific structures on Site Class D sites. The commentary for Section 11 of ASCE 7-16 (Page 534 of Section C11 of ASCE 7-16) states that “In general, this exception effectively limits the requirements for site-specific hazard analysis to very tall and or flexible structures at Site Class D sites.” Based on our understanding of the proposed structures, it is our assumption that the exception in Section 11.4.8 applies to the proposed structure. However, the structural engineer should verify the applicability of this exception.

Based on this exception, the spectral response accelerations presented below were calculated using the site coefficients ( $F_a$  and  $F_v$ ) from Tables 1613.2.3(1) and 1613.2.3(2) presented in Section 16.4.4 of the 2019 CBC.

Description	Value
Site Classification (CBC) <sup>1</sup>	D <sup>2</sup>
Site Latitude (°N)	33.8906
Site Longitude (°W)	117.2288
$S_s$ Spectral Acceleration for a 0.2-Second Period	1.5
$S_1$ Spectral Acceleration for a 1-Second Period	0.6
$F_a$ Site Coefficient for a 0.2-Second Period	1.0
$F_v$ Site Coefficient for a 1-Second Period	1.7
Site Modified Peak Ground Acceleration	0.661g
De-aggregated Modal Magnitude <sup>3</sup>	8.1

Description	Value
1. Seismic site classification in general accordance with the <i>2019 California Building Code</i> .	
2. The 2019 California Building Code (CBC) requires a site soil profile determination extending to a depth of 100 feet for seismic site classification. The current scope does not include the required 100-foot soil profile determination. Our borings were extended to a maximum depth of 51½ feet. This seismic site class definition considers that similar or denser soils continue below the maximum depth of the subsurface exploration. Additional exploration to deeper depths would be required to confirm the conditions below the current depth of exploration.	
3. These values were obtained using on-line Unified Hazard Tool by the USGS ( <a href="https://earthquake.usgs.gov/hazards/interactive/">https://earthquake.usgs.gov/hazards/interactive/</a> ) for return period of 2% in 50 years accessed	

A site-specific ground motion study may reduce design values and consequently construction costs. We recommend consulting with a structural engineer to evaluate the need for such study and its potential impact on construction costs. Terracon should be contacted if a site-specific ground motion study is desired.

### **Faulting and Estimated Ground Motions**

The site is located in the seismically active southern California area. The type and magnitude of seismic hazards affecting the site are dependent on the distance to causative faults, the intensity, and the magnitude of the seismic event. As calculated using the USGS Unified Hazard Tool, the San Jacinto (San Jacinto Valley segment) Fault, which is considered to have the most significant effect at the site from a design standpoint, has a maximum earthquake magnitude of 7.99 and is located approximately 10 kilometers from the site. Gridded point sources located a few kilometers north of the site comprise a seismic hazard nearly equal to that of the San Jacinto fault.

Based on the USGS Design Maps Summary Report, using the American Society of Civil Engineers (ASCE 7-16) standard, the peak ground acceleration (PGA<sub>M</sub>) at the project site is expected to be 0.661g. Based on the USGS Unified Hazard Tool, the project site has a de-aggregated modal magnitude of 8.1. The site is not located within an Alquist-Priolo Earthquake Fault Zone based on our review of the State Fault Hazard Maps.

## **LIQUEFACTION AND SEISMIC SETTLEMENT**

### **Liquefaction Potential**

Liquefaction is a mode of ground failure that results from the generation of high pore-water pressures during earthquake ground shaking, causing loss of shear strength, and is typically a hazard where loose sandy soils exist below groundwater. Riverside County has designated certain areas as potential liquefaction hazard zones. These are areas considered at a risk of liquefaction-related ground failure during a seismic event, based upon mapped surficial deposits and the presence of a relatively shallow water table.



## Geotechnical Engineering Report

Proposed Residential Development ■ Moreno Valley, Riverside County, California  
November 29, 2021 ■ Terracon Project No. CB205038



The subsurface materials generally consist of interbedded layers of silty sand, sandy and lean clays, and poorly graded sand with varying amounts of silt extending to the maximum depth of the borings. Groundwater was encountered at 39½ to 46½ feet bgs within three of the borings during drilling, and has historically ranged from 20 to greater than 100 feet bgs.

According to the County of Riverside geologic hazard GIS map, the site is located within an area having a moderate liquefaction potential. Based on the County of Riverside map, and the subsurface conditions encountered, we performed a liquefaction evaluation using the data from CPT tests CPT-1 to CPT-7.

### Seismic Settlement

To determine the amount of seismic settlement, we utilized the software "LiquefyPro" by CivilTech Software, seismic settlement was estimated using the soil profile from exploratory CPT test results. A Peak Ground Acceleration (PGA) of 0.661g and the de-aggregated mean magnitude of 7.04 were utilized as input into the liquefaction analysis program. Settlement analysis used the Ishihara / Yoshimine method and CPT calculation performed using the Modified Robertson method. We used a historical high ground water of 20 feet bgs for analysis.

Based on the calculation results, seismically induced settlement (dry sand and liquefaction settlement) is estimated to be on the order of 2 inches. The maximum differential seismic settlement could be on the order of half of total seismic settlement over a distance of 40 feet.

## GEOTECHNICAL OVERVIEW

The site appears suitable for the proposed construction based upon geotechnical conditions encountered in the test borings, provided that the recommendations provided in this report are implemented in the design and construction phases of this project.

Geotechnical engineering recommendations for foundation systems and other earth connected phases of the project are outlined below. The recommendations contained in this report are based upon the results of field and laboratory testing, engineering analyses, and our current understanding of the proposed project.

The subsurface materials generally consist of interbedded layers of silty sand, sandy lean clay, lean clay, and poorly graded sand with varying amounts of silt extending to the maximum depth of the borings. The soils encountered in the borings within the upper approximately 4 to 15 feet bgs were generally comprised of loose, silty sand and poorly graded sand with varying amount of silt. Layers of lean clay with varying amounts of sand were encountered at varying depths generally greater than 13 feet bgs with the exception of B-18 where it was encountered at 4 feet



bgs. On-site subsurface soils are not expected to experience substantial volumetric changes (shrink/swell) with fluctuations in moisture content.

The identification of previously placed fill soils was not discernable from native soils during the investigation and fill soils are likely present, particularly within the areas of existing structures. All fill soils should be removed during grading operations.

Based on the conditions encountered and assumptions regarding finish grade, the proposed buildings can be supported on shallow foundations, such as conventional spread footings provided the remedial grading outlined in this report is followed.

Groundwater was encountered in borings B-1, B-3 and B-13 at depths of 46½, 36½, and 39½ feet bgs respectively, Groundwater is not expected to affect shallow foundation construction on this site.

The **General Comments** section provides an understanding of the report limitations.

## **EARTHWORK**

The following recommendations include site preparation, excavation, subgrade preparation and placement of engineered fills on the project. The recommendations presented for design and construction of earth supported elements including foundations, slabs, and pavements are contingent upon following the recommendations outlined in this section.

The identification of previously placed fill soils was not discernable from native soils during the investigation, and there is the possibility that support of pavements may be on or above existing fill materials not encountered during this study; however, even with the recommended construction testing services, there is an inherent risk for the owner that compressible fill or unsuitable material within or buried by the fill will not be discovered. This risk of unforeseen conditions cannot be eliminated without completely removing the existing fill, but can be reduced by performing additional testing and evaluation.

Earthwork on the project should be observed and evaluated by Terracon. The evaluation of earthwork should include observation and testing of engineered fill, subgrade preparation, foundation bearing soils, and other geotechnical conditions exposed during the construction of the project.

### **Site Preparation**

Strip and remove existing vegetation, debris, pavements and other deleterious materials from proposed buildings and pavement areas. Exposed surfaces should be free of mounds and depressions which could prevent uniform compaction. The site should be initially graded to create

a relatively level surface to receive fill and provide for a relatively uniform thickness of fill beneath proposed building structures.

Demolition of the existing buildings should include complete removal of all foundation systems and remaining underground utilities within the proposed construction area. This should include removal of any loose backfill found adjacent to existing foundations. All materials derived from the demolition of existing structures and pavements should be removed from the site and not be allowed for use as on-site fill, unless processed in accordance with the fill requirements included in this report.

Although evidence of underground facilities such as septic tanks, cesspools, and basements was not observed during the reconnaissance, such features could be encountered during construction. If unexpected fills, utilities, or underground facilities are encountered, such features should be removed and the excavation thoroughly cleaned prior to backfill placement and/or construction.

### **Subgrade Preparation**

All previously placed fill associated with any previous development should be removed within the proposed development area. We recommend that the proposed buildings be supported on engineered fill extending to a minimum depth of 3 feet below the bottom of foundations, or 5 feet below existing grades, whichever is greater. Engineered fill placed beneath the entire footprint of the building should extend horizontally a minimum distance of 3 feet beyond the outside edge of perimeter footings.

Subgrade soils beneath exterior slabs and pavements should be removed to a depth of 2 feet below existing grade or bottom of proposed pavement section, whichever is greater, and replaced as engineered fill to the proposed grades. The bottom of excavations should then be scarified, moisture conditioned, and compacted to a minimum depth of 10 inches. The moisture content and compaction of subgrade soils should be maintained until slab or pavement construction.

Exposed areas which will receive fill, once properly cleared and benched where necessary, should be scarified to a minimum depth of 10 inches, moisture conditioned as necessary, and compacted per the compaction requirements in this report. Compacted fill soils should then be placed to the design grades, and the moisture content and compaction of soils should be maintained until slab, pavement, or proposed improvements are constructed.

Based upon the subsurface conditions determined from the geotechnical exploration, the on site soils are suitable for the proposed fill soils provided they are free from any organics and debris. and the on site soils are anticipated to be relatively workable; however, the workability of the soils may be affected by precipitation, repetitive construction traffic or other factors. If unworkable conditions develop, workability may be improved by scarifying and drying.

## Geotechnical Engineering Report

Proposed Residential Development ■ Moreno Valley, Riverside County, California  
November 29, 2021 ■ Terracon Project No. CB205038



### Excavation

We anticipate that excavations for the proposed construction can be accomplished with conventional earthmoving equipment. The bottom of excavations should be thoroughly cleaned of loose soils and disturbed materials prior to backfill placement and/or construction.

Individual contractors are responsible for designing and constructing stable, temporary excavations. Excavations should be sloped or shored in the interest of safety following local, and federal regulations, including current OSHA excavation and trench safety standards.

### Fill Material Types

All fill materials should be inorganic soils free of vegetation, debris, and fragments larger than three inches in size. Pea gravel or other similar non-cementitious, poorly-graded materials should not be used as fill or backfill without the prior approval of the geotechnical engineer.

Clean on-site soils or approved imported materials may be used as fill material for the following:

■ general site grading	■ foundation backfill
■ foundation areas	■ pavement areas
■ interior floor slab areas	■ exterior slab areas

If imported soils are used as fill materials to raise grades, these soils should conform to low volume change materials and should conform to the following requirements:

<b>Gradation</b>	<b>Percent Finer by Weight (ASTM C 136)</b>
3" .....	100
No. 4 Sieve .....	50 - 100
No. 200 Sieve .....	20 - 50
■ Liquid Limit .....	30 (max)
■ Plasticity Index .....	15 (max)
■ Maximum Expansive Index* .....	20 (max)

\*ASTM D 4829

The contractor shall notify the Geotechnical Engineer of import sources sufficiently ahead of their use so that the sources can be observed and approved as to the physical characteristic of the import material. For all import material, the contractor shall also submit current verified reports from a recognized analytical laboratory indicating that the import has a "not applicable" (Class S0) potential for sulfate attack based upon current ACI criteria and is "mildly corrosive" to ferrous metal and copper. The reports shall be accompanied by a written statement from the contractor

that the laboratory test results are representative of all import material that will be brought to the job.

Engineered fill should be placed and compacted in horizontal lifts, using equipment and procedures that will produce recommended moisture contents and densities throughout the lift. Fill lifts should not exceed 10 inches loose thickness.

**Compaction Requirements**

Material Type and Location	Per the Modified Proctor Test (ASTM D 1557)		
	Minimum Compaction Requirement (%)	Range of Moisture Contents for Compaction Above Optimum	
		Minimum	Maximum
On-site soils and/or low volume change imported fill:			
Beneath foundations:	90	0%	+3%
Beneath interior slabs:	90	0%	+3%
Miscellaneous backfill:	90	0%	+3%
Beneath pavements:	95	0%	+3%
Utility Trenches*:	90	0%	+3%
Bottom of excavation receiving fill:	90	0%	+3%
Aggregate base (beneath pavements):	95	0%	+3%

\* Upper 12 inches should be compacted to 95% within pavement and structural areas.

**Utility Trenches**

We anticipate that the on-site soils will provide suitable support for underground utilities and piping that may be installed. Any soft and/or unsuitable material encountered at the bottom of excavations should be removed and be replaced with an adequate bedding material. A non-expansive granular material with a sand equivalent greater than 30 is recommended for bedding and shading of utilities, unless otherwise allowed by the utility manufacturer.

On-site materials are considered suitable for backfill of utility and pipe trenches from one foot above the top of the pipe to the final ground surface, provided the material is free of organic matter and deleterious substances.

Trench backfill should be mechanically placed and compacted as discussed earlier in this report. Compaction of initial lifts should be accomplished with hand-operated tampers or other lightweight compactors. Where trenches are placed beneath slabs or footings, the backfill should satisfy the

gradation and expansion index requirements of engineered fill discussed in this report. Flooding or jetting for placement and compaction of backfill is not recommended.

### **Grading and Drainage**

Positive drainage should be provided during construction and maintained throughout the life of the development. Infiltration of water into utility trenches or foundation excavations should be prevented during construction. Planters and other surface features which could retain water in areas adjacent to the building or pavements should be sealed or eliminated. In areas where sidewalks or paving do not immediately adjoin the structure, we recommend that protective slopes be provided with a minimum grade of approximately 5 percent for at least 10 feet from perimeter walls. Backfill against footings, exterior walls, and in utility and sprinkler line trenches should be well compacted and free of all construction debris to reduce the possibility of moisture infiltration.

We recommend a minimum horizontal setback distance of 10 feet from the perimeter of any building and the high-water elevation of the nearest storm-water retention basin.

Roof drainage should discharge into splash blocks or extensions when the ground surface beneath such features is not protected by exterior slabs or paving. Sprinkler systems and landscaped irrigation should not be installed within 5 feet of foundation walls.

### **Exterior Slab Design and Construction**

Exterior slabs-on-grade, exterior architectural features, and utilities founded on, or in backfill may experience some movement due to the volume change of the backfill. To reduce the potential for damage caused by movement, we recommend:

- minimizing moisture increases in the backfill;
- controlling moisture-density during placement of backfill;
- using designs which allow vertical movement between the exterior features and adjoining structural elements;
- placing effective control joints on relatively close centers.

### **Construction Considerations**

Upon completion of filling and grading, care should be taken to maintain the subgrade moisture content prior to construction of floor slabs and pavements. Construction traffic over the completed subgrade should be avoided to the extent practical. The site should also be graded to prevent ponding of surface water on the prepared subgrades or in excavations. If the subgrade should become desiccated, saturated, or disturbed, the affected material should be removed or these materials should be scarified, moisture conditioned, and recompacted prior to floor slab and pavement construction.

## Geotechnical Engineering Report

Proposed Residential Development ■ Moreno Valley, Riverside County, California  
November 29, 2021 ■ Terracon Project No. CB205038



Onsite soils contains zones of cohesionless sandy soils. Such soils have the tendency to cave and slough during excavations. Therefore, formwork may be needed for foundation excavations.

We recommend that the earthwork portion of this project be completed during extended periods of dry weather if possible. If earthwork is completed during the wet season (typically November through April) it may be necessary to take extra precautionary measures to protect subgrade soils. Wet season earthwork operations may require additional mitigative measures beyond that which would be expected during the drier summer and fall months. This could include diversion of surface runoff around exposed soils and draining of ponded water on the site. Once subgrades are established, it may be necessary to protect the exposed subgrade soils from construction traffic.

### Construction Observation and Testing

The geotechnical engineer should be retained during the construction phase of the project to observe earthwork and to perform necessary tests and observations during subgrade preparation, proof-rolling, placement and compaction of controlled compacted fills, backfilling of excavations to the completed subgrade.

The exposed subgrade and each lift of compacted fill should be tested, evaluated, and reworked as necessary until approved by the Geotechnical Engineer prior to placement of additional lifts. Each lift of fill should be tested for density and water content at a frequency of at least one test for every 2,500 square feet of compacted fill in the building areas and 5,000 square feet in pavement areas. One density and water content test for every 50 linear feet of compacted utility trench backfill.

In areas of foundation excavations, the bearing subgrade should be evaluated under the direction of the Geotechnical Engineer. In the event that unanticipated conditions are encountered, the Geotechnical Engineer should prescribe mitigation options.

In addition to the documentation of the essential parameters necessary for construction, the continuation of the Geotechnical Engineer into the construction phase of the project provides the continuity to maintain the Geotechnical Engineer's evaluation of subsurface conditions, including assessing variations and associated design changes.

## SHALLOW FOUNDATIONS

If the site has been prepared in accordance with the requirements noted in **Earthwork**, the following design parameters are applicable for shallow foundations.

Item	Description
<b>Foundation Support</b>	Engineered fill extending 3 feet below the bottom of foundations, or 5 feet below existing grades, whichever is greater.
<b>Net Allowable Bearing pressure<sup>1, 2</sup> (On-site soils or structural fill)</b>	2,500 psf
<b>Minimum Foundation Dimensions</b>	Columns: 24 inches Continuous: 18 inches
<b>Minimum Footing Depth</b>	24" below finished grade
<b>Ultimate Passive Resistance<sup>4</sup></b>	350 pcf
<b>Ultimate Coefficient of Sliding Friction<sup>5</sup></b>	0.36
<b>Estimated Total Static Settlement from Structural Loads<sup>2</sup></b>	about 1 inch
<b>Estimated Differential Settlement<sup>2, 6</sup></b>	About 1/2 of total settlement

1. The maximum net allowable bearing pressure is the pressure in excess of the minimum surrounding overburden pressure at the footing base elevation. An appropriate factor of safety has been applied.
2. Values provided are for maximum loads noted in **Project Description**. The foundation settlement will depend upon the variations within the subsurface soil profile, the structural loading conditions, the embedment depth of the footings, the thickness of compacted fill, and the quality of the earthwork operations.
3. Unsuitable or soft soils should be over-excavated and replaced per the recommendations presented in the **Earthwork**.
4. Use of passive earth pressures requires the footing forms be removed and compacted structural fill be placed against the vertical footing face. A factor of safety of 2.0 is recommended.
5. Can be used to compute sliding resistance where foundations are placed on suitable soil/materials. Should be neglected for foundations subject to net uplift conditions. A factor of safety of 1.5 is recommended.
6. Differential settlements are as measured over a span of 40 feet.

### Shallow Foundations Designed for Uplift Conditions

Reinforced concrete footing foundations for canopy structures, cast against undisturbed native soils, are recommended for resistance to uplift. Footings may be designed using the cone method. The equation for determining the ultimate uplift capacity as a function of footing dimension, foundation depth, and soil weight based on the import low volume change soils is:



$$T_u = \gamma \times D^2 \times (B + L) + W$$

Where:

Variable	Description	Unit
$T_u$	Ultimate uplift capacity	lbs.
$\gamma$	Unit weight of soil <sup>1</sup>	pcf
$D$	Depth to base of footing/dead-man foundation below final grade	ft
$B$	Width of footing/dead-man foundation	ft
$L$	Length of footing/dead-man foundation	ft
$W$	Weight of footing/dead-man + weight of soil directly over the top of the footing/block	lbs.

<sup>1</sup>A unit weight ( $\gamma$ ) of 120 pcf is recommended for soil (either undisturbed or compacted backfill) at this site.

The design uplift resistance should be calculated by dividing the ultimate resistance obtained from the equation above by an appropriate factor of safety. A factor of safety of at least 2 is recommended for live uplift loads in the analysis.

### Foundation Construction Considerations

As noted in **Earthwork**, the footing excavations should be evaluated under the direction of the Geotechnical Engineer. The base of all foundation excavations should be free of water and loose soil, prior to placing concrete. Concrete should be placed soon after excavating to reduce bearing soil disturbance. Care should be taken to prevent wetting or drying of the bearing materials during construction. Excessively wet or dry material or any loose/disturbed material in the bottom of the footing excavations should be removed/reconditioned before foundation concrete is placed.

To ensure foundations have adequate support, special care should be taken when footings are located adjacent to trenches. The bottom of such footings should be at least 1 foot below an imaginary plane with an inclination of 1.5 horizontal to 1.0 vertical extending upward from the nearest edge of adjacent trenches.

### FLOOR SLABS

DESCRIPTION	RECOMMENDATION
<b>Interior floor system</b>	Slab-on-grade concrete
<b>Floor slab support</b>	Engineered fill extending 3 feet below the bottom of associated foundations, or 5 feet below existing grades, whichever is greater.
<b>Subbase</b>	Minimum 4-inches of Aggregate Base



DESCRIPTION	RECOMMENDATION
<b>Modulus of subgrade reaction</b>	150 pounds per square inch per inch (psi/in) (The modulus was obtained based on estimates obtained from NAVFAC 7.1 design charts). This value is for a small loaded area (1 Sq. ft or less) such as for forklift wheel loads or point loads and should be adjusted for larger loaded areas.

The use of a vapor retarder should be considered beneath concrete slabs on grade covered with wood, tile, carpet, or other moisture sensitive or impervious coverings, or when the slab will support equipment sensitive to moisture. When conditions warrant the use of a vapor retarder, the slab designer should refer to ACI 302 and/or ACI 360 for procedures and cautions regarding the use and placement of a vapor retarder.

Saw-cut control joints should be placed in the slab to help control the location and extent of cracking. For additional recommendations refer to the ACI Design Manual. Joints or cracks should be sealed with a water-proof, non-extruding compressible compound specifically recommended for heavy duty concrete pavement and wet environments.

Where floor slabs are tied to perimeter walls or turn-down slabs to meet structural or other construction objectives, our experience indicates differential movement between the walls and slabs will likely be observed in adjacent slab expansion joints or floor slab cracks beyond the length of the structural dowels. The Structural Engineer should account for potential differential settlement through use of sufficient control joints, appropriate reinforcing or other means.

## PAVEMENTS

### General Pavement Comments

Pavement designs are provided for the traffic conditions and pavement life conditions as noted in **Project Description** and in the following sections of this report. A critical aspect of pavement performance is site preparation. Pavement designs noted in this section must be applied to the site which has been prepared as recommended in the **Earthwork** section.

### Pavement Design Parameters

Design of asphalt concrete (AC) pavements is based on the procedures outlined in the Caltrans "Highway Design Manual for Safety Roadside Rest Areas" (Caltrans, 2016). Design of Portland cement concrete (PCC) pavements are based upon American Concrete Institute (ACI) 330R-08; "Guide for Design and Construction of Concrete Parking Lots."

During the field investigation at the site, one sample of the near surface soil taken from our borings was tested in our laboratory to determine the Hveem Stabilometer Value (R-value). The test produced an R-value of 50 and was used to calculate the AC pavement thickness sections. A

modulus of subgrade reaction of 150 pci and a modulus of rupture of 600 psi were used for the PCC pavement designs.

The structural sections are predicated upon proper compaction of the utility trench backfills and the subgrade soils as prescribed by in **Earthwork**, with the upper 12 inches of subgrade soils and all aggregate base material brought to a minimum relative compaction of 95 percent in accordance with ASTM D 1557 prior to paving. The aggregate base should meet Caltrans requirements for Class 2 base.

The pavement designs were based upon the results of preliminary sampling and testing and should be verified by additional sampling and testing (specifically R-value testing) during construction when the actual subgrade soils are exposed. Additionally, the preliminary sections provided are minimums based on procedures previously referenced. The project civil engineer should confirm minimum Traffic Indices and sections required by local agencies or jurisdictions if applicable.

**Pavement Section Thicknesses**

The following table provides options for AC and PCC Sections:

Asphalt Concrete Design		
Usage	Assumed Traffic Index	Recommended Structural Section
Auto Parking Areas	4.5	3" HMA <sup>1</sup> /4" Class 2 AB <sup>2</sup>
Drive lanes	5.5	3" HMA <sup>1</sup> /4" Class 2 AB <sup>2</sup>
Truck Delivery Areas	6.0	3.5" HMA <sup>1</sup> /4" Class 2 AB <sup>2</sup>

1. HMA = hot mix asphalt  
 2. AB = aggregate base

Portland Cement Concrete Design			
Layer	Thickness (inches)		
	Light Duty <sup>1</sup>	Medium Duty <sup>2</sup>	Dumpster Pad <sup>3</sup>
PCC	4.0	5.0	6.5
Aggregate Base <sup>4</sup>	--	--	--

1. Car Parking and Access Lanes, Average Daily Truck Traffic (ADTT) = 1 (Category A).  
 2. Truck Parking Areas, Multiple Units, ADTT = 25 (Category B)

Portland Cement Concrete Design			
Layer	Thickness (inches)		
	Light Duty <sup>1</sup>	Medium Duty <sup>2</sup>	Dumpster Pad <sup>3</sup>

3. In areas of anticipated heavy traffic, fire trucks, delivery trucks, or concentrated loads (e.g., dumpster pads), and areas with repeated turning or maneuvering of heavy vehicles, ADTT = 700 (Category C).

4. Aggregate base is not required. Compacted on-site material is considered competent.

Recommended structural sections were calculated based on assumed TIs and our preliminary sampling and testing.

Terracon does not practice traffic engineering. We recommend that the project civil engineer or traffic engineer verify that the TIs and ADTT traffic indices used are appropriate for this project.

### Pavement Drainage

Pavements should be sloped to provide rapid drainage of surface water. Water allowed to pond on or adjacent to the pavements could saturate the subgrade and contribute to premature pavement deterioration. In addition, the pavement subgrade should be graded to provide positive drainage within the granular base section. Appropriate sub-drainage or connection to a suitable daylight outlet should be provided to remove water from the granular subbase.

### Pavement Maintenance

The pavement sections represent minimum recommended thicknesses and, as such, periodic maintenance should be anticipated. Therefore, preventive maintenance should be planned and provided for through an on-going pavement management program. Maintenance activities are intended to slow the rate of pavement deterioration and to preserve the pavement investment. Maintenance consists of both localized maintenance (e.g., crack and joint sealing and patching) and global maintenance (e.g., surface sealing). Preventive maintenance is usually the priority when implementing a pavement maintenance program. Additional engineering observation is recommended to determine the type and extent of a cost-effective program. Even with periodic maintenance, some movements and related cracking may still occur and repairs may be required.

Pavement performance is affected by its surroundings. In addition to providing preventive maintenance, the civil engineer should consider the following recommendations in the design and layout of pavements:

- Final grade adjacent to paved areas should slope down from the edges at a minimum 2 percent.
- Subgrade and pavement surfaces should have a minimum 2 percent slope to promote proper surface drainage.

- Install below pavement drainage systems surrounding areas anticipated for frequent wetting.
- Install joint sealant and seal cracks immediately.
- Seal all landscaped areas in or adjacent to pavements to reduce moisture migration to subgrade soils.
- Place compacted, low permeability backfill against the exterior side of curb and gutter.
- Place curb, gutter and/or sidewalk directly on clay subgrade soils rather than on unbound granular base course materials.

## CORROSIVITY

The following table lists the laboratory electrical resistivity (standard and as-received), chlorides, soluble sulfates, and pH testing results. These values may be used to estimate potential corrosive characteristics of the on-site soils with respect to contact with the various underground materials which will be used for project construction.

Boring	Depth (feet)	Soluble Sulfate (mg/kg)	Soluble Chloride (mg/kg)	Total Salts (mg/kg)	pH	Resistivity (as-received) (Ohm-cm)	Resistivity (saturated) (Ohm-cm)
B-8	0 to 5	83	53	239	7.73	34,920	4,462

Results of soluble sulfate testing indicate samples of the on-site soils tested possess negligible sulfate concentrations when classified in accordance with Table 4.3.1 of the ACI Design Manual. Concrete should be designed in accordance with the provisions of the ACI Design Manual, Section 318, Chapter 4.

For protection against corrosion to buried metals, Terracon recommends that an experienced corrosion engineer be retained to design a suitable corrosion protection system for underground metal structures or components.

If corrosion of buried metal is critical, it should be protected using a non-corrosive backfill, wrapping, coating, sacrificial anodes, or a combination of these methods, as designed by a qualified corrosion engineer.

## GENERAL COMMENTS

Our analysis and opinions are based upon our understanding of the project, the geotechnical conditions in the area, and the data obtained from our site exploration. Natural variations will occur between exploration point locations or due to the modifying effects of construction or weather. The nature and extent of such variations may not become evident until during or after construction.

## Geotechnical Engineering Report

Proposed Residential Development ■ Moreno Valley, Riverside County, California  
November 29, 2021 ■ Terracon Project No. CB205038



Terracon should be retained as the Geotechnical Engineer, where noted in this report, to provide observation and testing services during pertinent construction phases. If variations appear, we can provide further evaluation and supplemental recommendations. If variations are noted in the absence of our observation and testing services on-site, we should be immediately notified so that we can provide evaluation and supplemental recommendations.

Our Scope of Services does not include either specifically or by implication any environmental or biological (e.g., mold, fungi, bacteria) assessment of the site or identification or prevention of pollutants, hazardous materials or conditions. If the owner is concerned about the potential for such contamination or pollution, other studies should be undertaken.

Our services and any correspondence or collaboration through this system are intended for the sole benefit and exclusive use of our client for specific application to the project discussed and are accomplished in accordance with generally accepted geotechnical engineering practices with no third-party beneficiaries intended. Any third-party access to services or correspondence is solely for information purposes to support the services provided by Terracon to our client. Reliance upon the services and any work product is limited to our client, and is not intended for third parties. Any use or reliance of the provided information by third parties is done solely at their own risk. No warranties, either express or implied, are intended or made.

Site characteristics as provided are for design purposes and not to estimate excavation cost. Any use of our report in that regard is done at the sole risk of the excavating cost estimator as there may be variations on the site that are not apparent in the data that could significantly impact excavation cost. Any parties charged with estimating excavation costs should seek their own site characterization for specific purposes to obtain the specific level of detail necessary for costing. Site safety, and cost estimating including, excavation support, and dewatering requirements/design are the responsibility of others. If changes in the nature, design, or location of the project are planned, our conclusions and recommendations shall not be considered valid unless we review the changes and either verify or modify our conclusions in writing.

## ATTACHMENTS

## EXPLORATION AND TESTING PROCEDURES

### Field Exploration

Terracon conducted six (6) soil-testing borings. These borings were drilled at the locations and to depths indicated in the table below.

Boring Number	Boring Depth (feet) <sup>1</sup>	Location
B-1	51½	EU-1
B-2	31 ½	EU-2
B-3	51½	EU-3
B-4	21 ½	BH-18
B-5	21 ½	Carport
B-6	21 ½	BH-11
B-7	21 ½	BH-10
B-8	31 ½	BH-17
B-9	31 ½	BH-9
B-10	21 ½	BH-13
B-11	21 ½	BH-8
B-12	21 ½	BH-15
B-13	51½	BH-14
B-14	21 ½	Carport
B-15	21 ½	Club/Leasing
B-16	21 ½	BH-7
B-17	31 ½	BH-1
B-18	21 ½	BH-4
CPT-1	50	EU-1
CPT-2	50	EU-2
CPT-3	50	EU-3
CPT-4	100	BH-12
CPT-5	50	BH-16
CPT-6	50	BH-6
CPT-7	50	BH-2 and BH-3

1. Below ground surface.

**Cone Penetration Test:** The Cone Penetration Test (CPT) soundings were performed in accordance with ASTM D 5778. CPT testing has proven to be a more reliable approach to characterize the subsurface conditions for seismic settlement analysis than SPT/ring sampling with conventional borings.

**Boring/CPT Layout and Elevations:** Unless otherwise noted, Terracon personnel provided the boring layout. Coordinates were obtained with a handheld GPS unit (estimated horizontal accuracy of about  $\pm 10$  feet) and approximate elevations were obtained by interpolation from the Google Earth. If elevations and a more precise boring layout are desired, we recommend borings be surveyed following completion of fieldwork.

**Subsurface Exploration Procedures:** We advance the borings with a truck-mounted drill rig using hollow-stem augers. Both a standard penetration test (SPT) sampler (2-inch outer diameter and 1-3/8-inch inner diameter) and a modified California ring-lined sampler (3-inch outer diameter and 2-3/8-inch inner diameter) are utilized in our investigation. The penetration resistance is recorded on the boring logs as the number of hammer blows used to advance the sampler in 6-inch increments (or less if noted). The samplers are driven with an automatic hammer that drops a 140-pound weight 30 inches for each blow. After the required seating, samplers are advanced up to 18 inches, providing up to three sets of blowcounts at each sampling interval. The sampling depths, penetration distances, and other sampling information are recorded on the field boring logs. The recorded blows are raw numbers without any corrections for hammer type (automatic vs. manual cathead) or sampler size (ring sampler vs. SPT sampler). Relatively undisturbed and bulk samples of the soils encountered are placed in sealed containers and returned to the laboratory for testing and evaluation.

We observe and record groundwater levels during drilling and sampling. For safety purposes, all borings are backfilled with auger cuttings after their completion.

Our exploration team prepares field boring logs as part of the drilling operations. These field logs include visual classifications of the materials encountered during drilling and our interpretation of the subsurface conditions between samples. Final boring logs are prepared from the field logs. The final boring logs represent the Geotechnical Engineer's interpretation of the field logs and include modifications based on observations and tests of the samples in our laboratory.

## **Laboratory Testing**

The project engineer reviewed the field data and assigned laboratory tests to understand the engineering properties of the various soil strata, as necessary, for this project. Procedural standards noted below are for reference to methodology in general. In some cases, variations to methods were applied because of local practice or professional judgment. Standards noted below include reference to other, related standards. Such references are not necessarily applicable to describe the specific test performed.

- Water (Moisture) Content of Soil by Mass



- Laboratory Determination of Density (Unit Weight) of Soil Specimens
- Particle-Size Distribution (Gradation) of Soils Using Sieve Analysis
- Atterberg limits
- Modified Proctor test
- Hydro-consolidation
- R-value
- Corrosivity suite test

The laboratory testing program often included examination of soil samples by an engineer. Based on the material's texture and plasticity, we described and classified the soil samples in accordance with the Unified Soil Classification System.

## **SITE LOCATION AND EXPLORATION PLANS**

**EXPLORATION PLAN**

Proposed Residential Development ■ Moreno Valley, Riverside County, California  
November 29, 2021 ■ Terracon Project No. CB205038



DIAGRAM IS FOR GENERAL LOCATION ONLY, AND IS NOT INTENDED FOR CONSTRUCTION PURPOSES

MAP PROVIDED BY MICROSOFT BING MAPS



**EXPLORATION PLAN**

Proposed Residential Development ■ Moreno Valley, Riverside County, California  
November 29, 2021 ■ Terracon Project No. CB205038

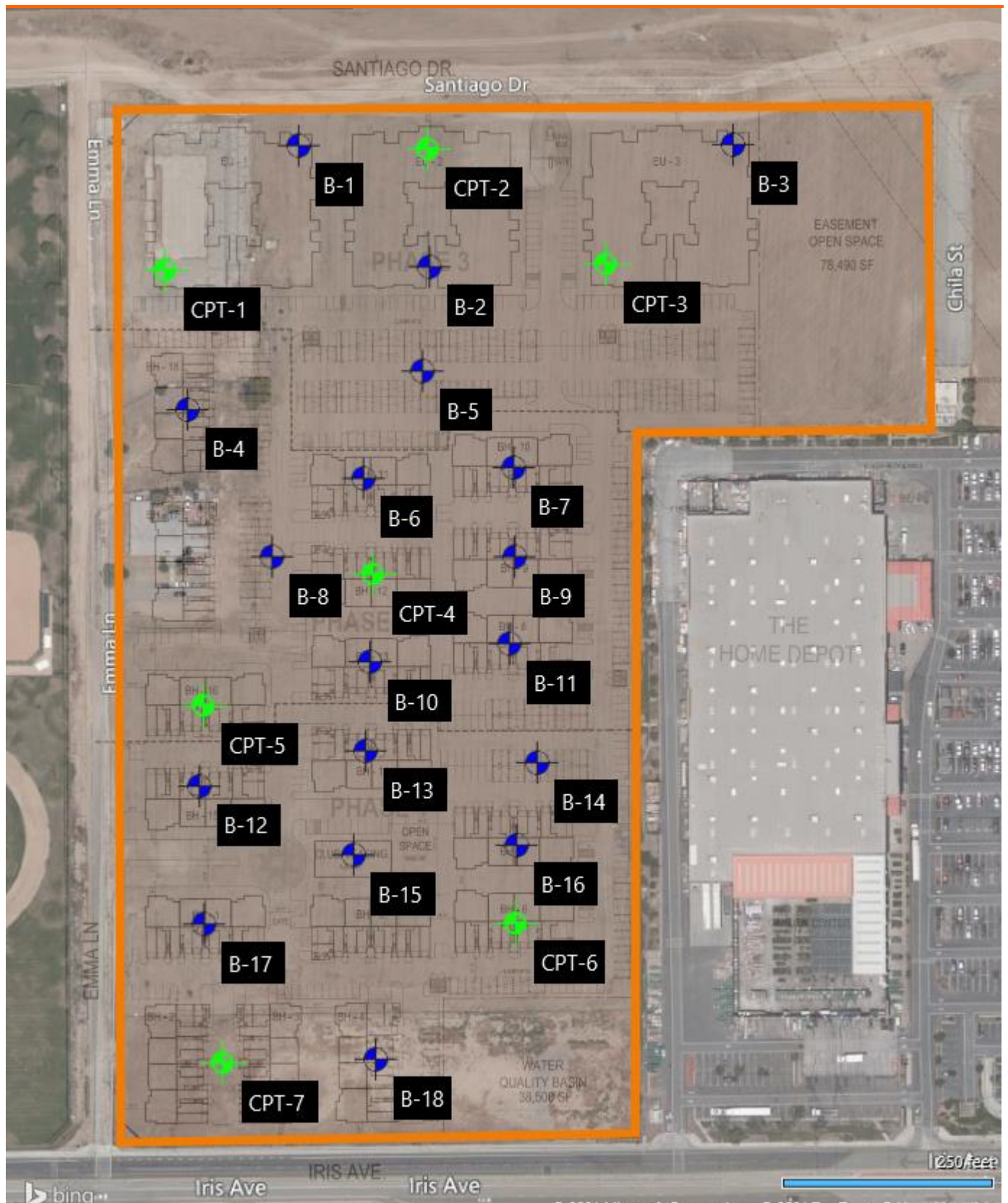

DIAGRAM IS FOR GENERAL LOCATION ONLY, AND IS NOT INTENDED FOR CONSTRUCTION

## **EXPLORATION RESULTS**

# BORING LOG NO. B-1

**PROJECT:** Proposed Residential Development

**CLIENT:** Perris at Pentecostal LLC  
Irvine, CA

**SITE:** Perris Boulevard & Santiago Drive  
Moreno Valley

GRAPHIC LOG	LOCATION See <a href="#">Exploration Plan</a> Latitude: 33.8918° Longitude: -117.2298°	DEPTH (FL)	WATER LEVEL OBSERVATIONS	SAMPLE TYPE	FIELD TEST RESULTS	WATER CONTENT (%)	DRY UNIT WEIGHT (pcf)	ATTERBERG LIMITS	
								LL-PL-PI	PERCENT FINES
DEPTH									
11.29/21	<b>SILTY SAND (SM)</b> , fine grained, brown, loose								
		5		7-8-6	2.7	103		NP	38 34
	fine to medium grained			2-2-6	6.5	104			28
		10		3-5-6	4.3	108			21
		15		3-6-6	4.4	104			21
	15.0								
	<b>SANDY LEAN CLAY (CL)</b> , brown, very stiff 2" silty sand lens at 16'	15		4-9-7 N=16					61
	20.0								
	<b>LEAN CLAY (CL)</b> , brown, very stiff	20		3-7-13 N=20					
	23.0								
	<b>SILTY SAND (SM)</b> , fine to coarse grained, brown, medium dense 6" sandy clay lens at 26'	25		5-7-4 N=11					33

Stratification lines are approximate. In-situ, the transition may be gradual.

Hammer Type: Automatic (79.3%)

Advancement Method:  
6" Hollow-Stem Auger

See [Exploration and Testing Procedures](#) for a description of field and laboratory procedures used and additional data (if any).

Notes:

Abandonment Method:  
Boring backfilled with auger cuttings upon completion.

See [Supporting Information](#) for explanation of symbols and abbreviations.

**WATER LEVEL OBSERVATIONS**

- While sampling
- 10 minutes after drilling



Boring Started: 10-15-2021

Boring Completed: 10-15-2021

Drill Rig: CME 75

Driller: Martini Drilling

Project No.: CB205038

THIS BORING LOG IS NOT VALID IF SEPARATED FROM ORIGINAL REPORT. GEO SMART LOG-NO WELL CB205038 PROPOSED RESIDENT.GPJ TERRACON\_DATATEMPLATE.GDT 11/29/21



# BORING LOG NO. B-1

**PROJECT:** Proposed Residential Development

**CLIENT:** Perris at Pentecostal LLC  
Irvine, CA

**SITE:** Perris Boulevard & Santiago Drive  
Moreno Valley

THIS BORING LOG IS NOT VALID IF SEPARATED FROM ORIGINAL REPORT. GEO SMART LOG-NO WELL CB205038 PROPOSED RESIDENT.GPJ TERRACON.DATATEMPLATE.GDT 11/29/21

GRAPHIC LOG	LOCATION See <a href="#">Exploration Plan</a> Latitude: 33.8918° Longitude: -117.2298°	DEPTH (FL)	WATER LEVEL OBSERVATIONS	SAMPLE TYPE	FIELD TEST RESULTS	WATER CONTENT (%)	DRY UNIT WEIGHT (pcf)	ATTERBERG LIMITS	
								LL-PL-PI	PERCENT FINES
	<b>SILTY SAND (SM)</b> , fine to coarse grained, brown, medium dense <i>(continued)</i>	30	X		6-6-5 N=11				30
	coarse sand and clay lenses								
	35.5	<b>SANDY LEAN CLAY (CL)</b> , brown, very stiff	35	X		7-9-10 N=19			50
	38.0	<b>LEAN CLAY (CL)</b> , brown, medium stiff	40	X		2-2-2 N=4		27-16-11	87
	43.0	<b>SANDY LEAN CLAY (CL)</b> , brown, stiff	45	X		2-3-6 N=9			56
	48.0	<b>SILTY SAND (SM)</b> , fine to coarse grained, brown, medium dense	50	▽		5-9-8 N=17			31
	<b>Boring Terminated at 51.5 Feet</b>								

Stratification lines are approximate. In-situ, the transition may be gradual.

Hammer Type: Automatic (79.3%)

Advancement Method:  
6" Hollow-Stem Auger

See [Exploration and Testing Procedures](#) for a description of field and laboratory procedures used and additional data (if any).

Notes:

Abandonment Method:  
Boring backfilled with auger cuttings upon completion.

See [Supporting Information](#) for explanation of symbols and abbreviations.

**WATER LEVEL OBSERVATIONS**

- ▽ While sampling
- ▽ 10 minutes after drilling



Boring Started: 10-15-2021

Boring Completed: 10-15-2021

Drill Rig: CME 75

Driller: Martini Drilling

Project No.: CB205038

# BORING LOG NO. B-2

**PROJECT:** Proposed Residential Development

**CLIENT:** Perris at Pentecostal LLC  
Irvine, CA

**SITE:** Perris Boulevard & Santiago Drive  
Moreno Valley

THIS BORING LOG IS NOT VALID IF SEPARATED FROM ORIGINAL REPORT. GEO SMART LOG-NO WELL CB205038 PROPOSED RESIDENT.GPJ TERRACON\_DATATEMPLATE.GDT 11/29/21

GRAPHIC LOG	LOCATION See <a href="#">Exploration Plan</a> Latitude: 33.8914° Longitude: -117.2293°	DEPTH (FL)	WATER LEVEL OBSERVATIONS	SAMPLE TYPE	FIELD TEST RESULTS	WATER CONTENT (%)	DRY UNIT WEIGHT (pcf)	ATTERBERG LIMITS		PERCENT FINES
								LL-PL-PI		
DEPTH										
0.0 - 8.0	<b>SILTY SAND (SM)</b> , fine grained, brown, loose  medium dense	5		X	3-3-5	3.0	104			
8.0 - 10.0	<b>POORLY GRADED SAND WITH SILT (SP-SM)</b> , fine to coarse grained, reddish brown, loose			X	4-8-11	5.3	111			
10.0 - 13.0	<b>POORLY GRADED SAND (SP)</b> , medium to coarse grained, reddish brown, medium dense	10		X	6-7-8	0.4	104			
13.0 - 23.0	<b>LEAN CLAY (CL)</b> , brown, stiff	15		X	4-7-12	0.4	113			
23.0 - 25.0	<b>SANDY LEAN CLAY (CL)</b> , brown, stiff	20		X	3-5-7 N=12				30-18-12	
25.0 - 27.0		25		X	3-5-11 N=16					
27.0 - 29.0				X	4-5-7 N=12					

Stratification lines are approximate. In-situ, the transition may be gradual.

Hammer Type: Automatic (79.3%)

Advancement Method:  
6" Hollow-Stem Auger

See [Exploration and Testing Procedures](#) for a description of field and laboratory procedures used and additional data (if any).

Notes:

Abandonment Method:  
Boring backfilled with auger cuttings upon completion.

See [Supporting Information](#) for explanation of symbols and abbreviations.

**WATER LEVEL OBSERVATIONS**

Groundwater not encountered



Boring Started: 10-15-2021

Boring Completed: 10-15-2021

Drill Rig: CME 75

Driller: Martini Drilling

Project No.: CB205038

# BORING LOG NO. B-2

**PROJECT:** Proposed Residential Development

**CLIENT:** Perris at Pentecostal LLC  
Irvine, CA

**SITE:** Perris Boulevard & Santiago Drive  
Moreno Valley

GRAPHIC LOG	LOCATION See <a href="#">Exploration Plan</a> Latitude: 33.8914° Longitude: -117.2293°	DEPTH (FL)	WATER LEVEL OBSERVATIONS	SAMPLE TYPE	FIELD TEST RESULTS	WATER CONTENT (%)	DRY UNIT WEIGHT (pcf)	ATTERBERG LIMITS LL-PL-PI	PERCENT FINES
	DEPTH								
	28.0 <b>SANDY LEAN CLAY (CL)</b> , brown, stiff <i>(continued)</i>								
	<b>SILTY SAND (SM)</b> , fine to coarse grained, brown, medium dense	30		X	7-10-11 N=21				
	31.5 <b>Boring Terminated at 31.5 Feet</b>								

Stratification lines are approximate. In-situ, the transition may be gradual.

Hammer Type: Automatic (79.3%)

Advancement Method:  
6" Hollow-Stem Auger

See [Exploration and Testing Procedures](#) for a description of field and laboratory procedures used and additional data (if any).

Notes:

Abandonment Method:  
Boring backfilled with auger cuttings upon completion.

See [Supporting Information](#) for explanation of symbols and abbreviations.

**WATER LEVEL OBSERVATIONS**

*Groundwater not encountered*



Boring Started: 10-15-2021

Boring Completed: 10-15-2021

Drill Rig: CME 75

Driller: Martini Drilling

Project No.: CB205038

THIS BORING LOG IS NOT VALID IF SEPARATED FROM ORIGINAL REPORT. GEO SMART LOG-NO WELL CB205038 PROPOSED RESIDENT.GPJ TERRACON\_DATATEMPLATE.GDT 11/29/21

# BORING LOG NO. B-3

**PROJECT:** Proposed Residential Development

**CLIENT:** Perris at Pentecostal LLC  
Irvine, CA

**SITE:** Perris Boulevard & Santiago Drive  
Moreno Valley

GRAPHIC LOG	LOCATION See <a href="#">Exploration Plan</a> Latitude: 33.8918° Longitude: -117.2281°	DEPTH (FL)	WATER LEVEL OBSERVATIONS	SAMPLE TYPE	FIELD TEST RESULTS	WATER CONTENT (%)	DRY UNIT WEIGHT (pcf)	ATTERBERG LIMITS	
								LL-PL-PI	PERCENT FINES
	DEPTH								
	<b>SILTY SAND (SM)</b> , fine to coarse grained, reddish brown, loose								
	5.0				3-5-6	5.3	107	NP	22
	<b>POORLY GRADED SAND WITH SILT (SP-SM)</b> , fine to coarse grained, reddish brown, loose	5			3-4-6	0.8			22
	medium to coarse grained				5-5-10	1.2	104		5
	9.5				5-12-21	9.9	117		43
<b>SILTY SAND (SM)</b> , fine grained, brown, medium dense		10							
loose		15		2-3-5 N=8				45	
18.0		20		5-11-18 N=29				50	
<b>SANDY LEAN CLAY (CL)</b> , reddish brown, very stiff		25		4-6-9 N=15				51	
stiff									
3" silty sand lens at 26'									

Stratification lines are approximate. In-situ, the transition may be gradual.

Hammer Type: Automatic (79.3%)

Advancement Method:  
6" Hollow-Stem Auger

See [Exploration and Testing Procedures](#) for a description of field and laboratory procedures used and additional data (if any).

Notes:

Abandonment Method:  
Boring backfilled with auger cuttings upon completion.

See [Supporting Information](#) for explanation of symbols and abbreviations.

**WATER LEVEL OBSERVATIONS**

- While sampling
- 10 minutes after sampling
- 10 minutes after drilling



Boring Started: 10-15-2021

Boring Completed: 10-15-2021

Drill Rig: CME 75

Driller: Martini Drilling

Project No.: CB205038

THIS BORING LOG IS NOT VALID IF SEPARATED FROM ORIGINAL REPORT. GEO SMART LOG-NO WELL CB205038 PROPOSED RESIDENT.GPJ TERRACON\_DATATEMPLATE.GDT 11/29/21

# BORING LOG NO. B-3

**PROJECT:** Proposed Residential Development

**CLIENT:** Perris at Pentecostal LLC  
Irvine, CA

**SITE:** Perris Boulevard & Santiago Drive  
Moreno Valley

THIS BORING LOG IS NOT VALID IF SEPARATED FROM ORIGINAL REPORT. GEO SMART LOG-NO WELL CB205038 PROPOSED RESIDENT.GPJ TERRACON\_DATATEMPLATE.GDT 11/29/21

GRAPHIC LOG	LOCATION See <a href="#">Exploration Plan</a> Latitude: 33.8918° Longitude: -117.2281°	DEPTH (FL)	WATER LEVEL OBSERVATIONS	SAMPLE TYPE	FIELD TEST RESULTS	WATER CONTENT (%)	DRY UNIT WEIGHT (pcf)	ATTERBERG LIMITS	
								LL-PL-PI	PERCENT FINES
	DEPTH								
	<b>SANDY LEAN CLAY (CL)</b> , reddish brown, very stiff ( <i>continued</i> )	28.0							
	<b>SILTY SAND (SM)</b> , fine to medium grained, brown, medium dense, with occasional sandy clay lenses	30.0			4-6-8 N=14				40
	<b>SANDY LEAN CLAY (CL)</b> , brown with olive, stiff	33.0							
	<b>SANDY LEAN CLAY (CL)</b> , brown with olive, stiff	36.5	▽		4-5-5 N=10				59
	<b>SILTY SAND (SM)</b> , fine to medium grained, brown, medium dense, with occasional coarse sand lenses	38.0	▽						
	<b>SANDY LEAN CLAY (CL)</b> , brown, stiff	41.5			6-10-11 N=21				20
	<b>SANDY LEAN CLAY (CL)</b> , brown, stiff	45.0			3-6-8 N=14				55
	<b>SILTY SAND (SM)</b> , fine to coarse grained, brown, medium dense	48.0							
	<b>SILTY SAND (SM)</b> , fine to coarse grained, brown, medium dense	51.5			7-11-12 N=23				16
	<b>Boring Terminated at 51.5 Feet</b>								

Stratification lines are approximate. In-situ, the transition may be gradual.

Hammer Type: Automatic (79.3%)

Advancement Method:  
6" Hollow-Stem Auger

See [Exploration and Testing Procedures](#) for a description of field and laboratory procedures used and additional data (if any).

Notes:

Abandonment Method:  
Boring backfilled with auger cuttings upon completion.

See [Supporting Information](#) for explanation of symbols and abbreviations.

**WATER LEVEL OBSERVATIONS**

- ▽ While sampling
- ▽ 10 minutes after sampling
- ▽ 10 minutes after drilling



Boring Started: 10-15-2021

Boring Completed: 10-15-2021

Drill Rig: CME 75

Driller: Martini Drilling

Project No.: CB205038

# BORING LOG NO. B-4

**PROJECT:** Proposed Residential Development

**CLIENT:** Perris at Pentecostal LLC  
Irvine, CA

**SITE:** Perris Boulevard & Santiago Drive  
Moreno Valley

THIS BORING LOG IS NOT VALID IF SEPARATED FROM ORIGINAL REPORT. GEO SMART LOG-NO WELL CB205038 PROPOSED RESIDENT.GPJ TERRACON\_DATATEMPLATE.GDT 11/29/21

GRAPHIC LOG	LOCATION See <a href="#">Exploration Plan</a> Latitude: 33.8909° Longitude: -117.2302°	DEPTH (FL)	WATER LEVEL OBSERVATIONS	SAMPLE TYPE	FIELD TEST RESULTS	WATER CONTENT (%)	DRY UNIT WEIGHT (pcf)	ATTERBERG LIMITS	PERCENT FINES
								LL-PL-PI	
	DEPTH								
7.0	<b>SILTY SAND (SM)</b> , fine to medium grained, brown, loose								
		5		X	5-8-10	0.4	115		
				X	5-8-9	2.0	108		
15.0	<b>POORLY GRADED SAND (SP)</b> , medium to coarse grained, reddish brown, loose								
		10		X	4-8-10	0.2	106		
				X	5-6-10	0.5	108		
18.0	<b>SILTY SAND (SM)</b> , fine to coarse grained, brown, medium dense								
		15		X	6-8-11 N=19				
21.5	<b>LEAN CLAY (CL)</b> , brown, stiff								
		20		X	2-4-10 N=14				
	<b>Boring Terminated at 21.5 Feet</b>								

Stratification lines are approximate. In-situ, the transition may be gradual.

Hammer Type: Automatic (79.3%)

Advancement Method:  
6" Hollow-Stem Auger

See [Exploration and Testing Procedures](#) for a description of field and laboratory procedures used and additional data (if any).

Notes:

Abandonment Method:  
Boring backfilled with auger cuttings upon completion.

See [Supporting Information](#) for explanation of symbols and abbreviations.

**WATER LEVEL OBSERVATIONS**

Groundwater not encountered



Boring Started: 10-15-2021

Boring Completed: 10-15-2021

Drill Rig: CME 75

Driller: Martini Drilling

Project No.: CB205038



# BORING LOG NO. B-5

**PROJECT:** Proposed Residential Development

**CLIENT:** Perris at Pentecostal LLC  
Irvine, CA

**SITE:** Perris Boulevard & Santiago Drive  
Moreno Valley

THIS BORING LOG IS NOT VALID IF SEPARATED FROM ORIGINAL REPORT. GEO SMART LOG-NO WELL CB205038 PROPOSED RESIDENT.GPJ TERRACON\_DATATEMPLATE.GDT 11/29/21

GRAPHIC LOG	LOCATION See <a href="#">Exploration Plan</a> Latitude: 33.8910° Longitude: -117.2293°	DEPTH (FL)	WATER LEVEL OBSERVATIONS	SAMPLE TYPE	FIELD TEST RESULTS	WATER CONTENT (%)	DRY UNIT WEIGHT (pcf)	ATTERBERG LIMITS	
								LL-PL-PI	PERCENT FINES
	DEPTH								
█	<b>SILTY SAND (SM)</b> , fine grained, brown, loose			█					
	very loose	5		X	3-4-6	3.6	107		40
	loose			X	1-2-1 N=3				46
	with occasional silt lenses	10		X	3-6-8	5.5	104		47
		15		X	2-2-2 N=4				38
█	<b>LEAN CLAY WITH SAND (CL)</b> , brown, very stiff	15.5		X	6-9-8 N=17				75
█	<b>SANDY LEAN CLAY (CL)</b> , reddish brown, hard	18.0		X					
█		21.5		X	8-14-28 N=42				55
	<b>Boring Terminated at 21.5 Feet</b>								

Stratification lines are approximate. In-situ, the transition may be gradual.

Hammer Type: Automatic (79.3%)

Advancement Method:  
6" Hollow-Stem Auger

See [Exploration and Testing Procedures](#) for a description of field and laboratory procedures used and additional data (if any).

Notes:

Abandonment Method:  
Boring backfilled with auger cuttings upon completion.

See [Supporting Information](#) for explanation of symbols and abbreviations.

**WATER LEVEL OBSERVATIONS**

Groundwater not encountered



Boring Started: 10-15-2021

Boring Completed: 10-15-2021

Drill Rig: CME 75

Driller: Martini Drilling

Project No.: CB205038

# BORING LOG NO. B-6

**PROJECT:** Proposed Residential Development

**CLIENT:** Perris at Pentecostal LLC  
Irvine, CA

**SITE:** Perris Boulevard & Santiago Drive  
Moreno Valley

GRAPHIC LOG	LOCATION See <a href="#">Exploration Plan</a> Latitude: 33.8907° Longitude: -117.2296°	DEPTH (FL)	WATER LEVEL OBSERVATIONS	SAMPLE TYPE	FIELD TEST RESULTS	WATER CONTENT (%)	DRY UNIT WEIGHT (pcf)	ATTERBERG LIMITS	PERCENT FINES
								LL-PL-PI	
	DEPTH								
7.0	<b>SILTY SAND (SM)</b> , fine grained, brown, loose	5		X	2-2-2 N=4				
7.0	<b>POORLY GRADED SAND (SP)</b> , medium to coarse grained, reddish brown, loose	7.0		X	2-3-9	1.9	111		
18.0	medium dense	10		X	2-3-5 N=8				
18.0	fine to coarse grained	15		X	7-12-12	1.0	110		
21.5	<b>SILTY SAND (SM)</b> , fine to coarse grained, brown, medium dense	20		X	8-8-9 N=17				
21.5	<b>Boring Terminated at 21.5 Feet</b>	21.5		X	7-12-12 N=24				

Stratification lines are approximate. In-situ, the transition may be gradual.

Hammer Type: Automatic (79.3%)

Advancement Method:  
6" Hollow-Stem Auger

See [Exploration and Testing Procedures](#) for a description of field and laboratory procedures used and additional data (if any).

Notes:

Abandonment Method:  
Boring backfilled with auger cuttings upon completion.

See [Supporting Information](#) for explanation of symbols and abbreviations.

**WATER LEVEL OBSERVATIONS**

Groundwater not encountered



Boring Started: 10-15-2021

Boring Completed: 10-15-2021

Drill Rig: CME 75

Driller: Martini Drilling

Project No.: CB205038

THIS BORING LOG IS NOT VALID IF SEPARATED FROM ORIGINAL REPORT. GEO SMART LOG-NO WELL CB205038 PROPOSED RESIDENT.GPJ TERRACON\_DATATEMPLATE.GDT 11/29/21

# BORING LOG NO. B-7

**PROJECT:** Proposed Residential Development

**CLIENT:** Perris at Pentecostal LLC  
Irvine, CA

**SITE:** Perris Boulevard & Santiago Drive  
Moreno Valley

THIS BORING LOG IS NOT VALID IF SEPARATED FROM ORIGINAL REPORT. GEO SMART LOG-NO WELL CB205038 PROPOSED RESIDENT.GPJ TERRACON\_DATATEMPLATE.GDT 11/29/21

GRAPHIC LOG	LOCATION See <a href="#">Exploration Plan</a> Latitude: 33.8907° Longitude: -117.2290°	DEPTH (FL)	WATER LEVEL OBSERVATIONS	SAMPLE TYPE	FIELD TEST RESULTS	WATER CONTENT (%)	DRY UNIT WEIGHT (pcf)	ATTERBERG LIMITS	
								LL-PL-PI	PERCENT FINES
	DEPTH								
	<b>SILTY SAND (SM)</b> , fine grained, brown, loose								
		5		X	2-3-4	2.4	105		
	fine to medium grained			X	2-2-2 N=4				
		10		X	5-7-9	5.2	110		
	11.0			X	2-2-2 N=4				
	<b>POORLY GRADED SAND (SP)</b> , medium to coarse grained, reddish brown, loose								
		15		X	6-9-12 N=21				
	13.0			X	4-6-10 N=16				
	<b>SILTY SAND (SM)</b> , fine to coarse grained, brown, medium dense, with interbedded clay lenses								
		20		X					
	21.5								
	<b>Boring Terminated at 21.5 Feet</b>								

Stratification lines are approximate. In-situ, the transition may be gradual.

Hammer Type: Automatic (79.3%)

Advancement Method:  
6" Hollow-Stem Auger

See [Exploration and Testing Procedures](#) for a description of field and laboratory procedures used and additional data (if any).

Notes:

Abandonment Method:  
Boring backfilled with auger cuttings upon completion.

See [Supporting Information](#) for explanation of symbols and abbreviations.

**WATER LEVEL OBSERVATIONS**

Groundwater not encountered



Boring Started: 10-15-2021

Boring Completed: 10-15-2021

Drill Rig: CME 75

Driller: Martini Drilling

Project No.: CB205038

# BORING LOG NO. B-8

**PROJECT:** Proposed Residential Development

**CLIENT:** Perris at Pentecostal LLC  
Irvine, CA

**SITE:** Perris Boulevard & Santiago Drive  
Moreno Valley

THIS BORING LOG IS NOT VALID IF SEPARATED FROM ORIGINAL REPORT. GEO SMART LOG-NO WELL CB205038 PROPOSED RESIDENT.GPJ TERRACON\_DATATEMPLATE.GDT 11/29/21

GRAPHIC LOG	LOCATION See <a href="#">Exploration Plan</a> Latitude: 33.8904° Longitude: -117.2303°	DEPTH (FL)	WATER LEVEL OBSERVATIONS	SAMPLE TYPE	FIELD TEST RESULTS	WATER CONTENT (%)	DRY UNIT WEIGHT (pcf)	ATTERBERG LIMITS	
								LL-PL-PI	PERCENT FINES
DEPTH									
0.0	<b>SILTY SAND (SM)</b> , fine grained, brown, loose								
	medium dense				9-8-13	3.2	51	NP	34 31
7.0					2-5-10	4.0	108		29
9.0	<b>POORLY GRADED SAND WITH SILT (SP-SM)</b> , medium to coarse grained, reddish brown, loose				4-7-10	1.0	108		7
	<b>POORLY GRADED SAND (SP)</b> , medium to coarse grained, reddish brown, medium dense				4-10-13	0.6	104		4
15.0									
20.0	<b>SILTY SAND (SM)</b> , fine to medium grained, brown, medium dense				5-5-5 N=10				29
	<b>SANDY LEAN CLAY (CL)</b> , dark brown, stiff				3-5-6 N=11				51
25	reddish brown				3-6-9 N=15				64

Stratification lines are approximate. In-situ, the transition may be gradual.

Hammer Type: Automatic (79.3%)

Advancement Method:  
6" Hollow-Stem Auger

See [Exploration and Testing Procedures](#) for a description of field and laboratory procedures used and additional data (if any).

Notes:

Abandonment Method:  
Boring backfilled with auger cuttings upon completion.

See [Supporting Information](#) for explanation of symbols and abbreviations.

**WATER LEVEL OBSERVATIONS**

Groundwater not encountered



Boring Started: 10-15-2021

Boring Completed: 10-15-2021

Drill Rig: CME 75

Driller: Martini Drilling

Project No.: CB205038

# BORING LOG NO. B-8

**PROJECT:** Proposed Residential Development

**CLIENT:** Perris at Pentecostal LLC  
Irvine, CA

**SITE:** Perris Boulevard & Santiago Drive  
Moreno Valley

GRAPHIC LOG	LOCATION See <a href="#">Exploration Plan</a> Latitude: 33.8904° Longitude: -117.2303°	DEPTH (FL)	WATER LEVEL OBSERVATIONS	SAMPLE TYPE	FIELD TEST RESULTS	WATER CONTENT (%)	DRY UNIT WEIGHT (pcf)	ATTERBERG LIMITS LL-PL-PI	PERCENT FINES
	DEPTH								
	28.0 <b>SANDY LEAN CLAY (CL)</b> , dark brown, stiff <i>(continued)</i>								
	<b>SILTY SAND (SM)</b> , fine grained, brown, medium dense	30		X	5-7-6 N=13				34
	31.5 <b>Boring Terminated at 31.5 Feet</b>								

Stratification lines are approximate. In-situ, the transition may be gradual.

Hammer Type: Automatic (79.3%)

Advancement Method:  
6" Hollow-Stem Auger

See [Exploration and Testing Procedures](#) for a description of field and laboratory procedures used and additional data (if any).

Notes:

Abandonment Method:  
Boring backfilled with auger cuttings upon completion.

See [Supporting Information](#) for explanation of symbols and abbreviations.

**WATER LEVEL OBSERVATIONS**

*Groundwater not encountered*



Boring Started: 10-15-2021

Boring Completed: 10-15-2021

Drill Rig: CME 75

Driller: Martini Drilling

Project No.: CB205038

THIS BORING LOG IS NOT VALID IF SEPARATED FROM ORIGINAL REPORT. GEO SMART LOG-NO WELL CB205038 PROPOSED RESIDENT.GPJ TERRACON\_DATATEMPLATE.GDT 11/29/21

# BORING LOG NO. B-9

**PROJECT:** Proposed Residential Development

**CLIENT:** Perris at Pentecostal LLC  
Irvine, CA

**SITE:** Perris Boulevard & Santiago Drive  
Moreno Valley

GRAPHIC LOG	LOCATION See <a href="#">Exploration Plan</a> Latitude: 33.8904° Longitude: -117.2290°	DEPTH (FL)	WATER LEVEL OBSERVATIONS	SAMPLE TYPE	FIELD TEST RESULTS	WATER CONTENT (%)	DRY UNIT WEIGHT (pcf)	ATTERBERG LIMITS	PERCENT FINES
								LL-PL-PI	
DEPTH									
7.0	<b>SILTY SAND (SM)</b> , trace gravel up to 1/4", fine to coarse grained, yellowish brown, loose	5		X	4-6-6	2.4	109		
7.0		5		X	3-4-5	3.0	110		
15.0	<b>POORLY GRADED SAND WITH SILT (SP-SM)</b> , trace gravel up to 1/4", fine to coarse grained, grayish brown, loose to medium dense	10		X	4-7-8	0.7			
15.0		10		X	4-6-8	0.7	109		
20.0	<b>SILTY SAND (SM)</b> , trace gravel up to 1/4", fine grained, brown, medium dense	15		X	5-9-12 N=21				
20.0		20		X	3-5-8 N=13				
25.0	<b>SANDY LEAN CLAY (CL)</b> , fine to coarse grained, brown, stiff	25		X	8-13-14 N=27				
25.0		25		X					
25.0	<b>SILTY SAND (SM)</b> , trace clay, fine to coarse grained, brown, medium dense	25		X					

Stratification lines are approximate. In-situ, the transition may be gradual.

Hammer Type: Automatic (79.3%)

Advancement Method:  
6" Hollow-Stem Auger

See [Exploration and Testing Procedures](#) for a description of field and laboratory procedures used and additional data (if any).

Notes:

Abandonment Method:  
Boring backfilled with auger cuttings upon completion.

See [Supporting Information](#) for explanation of symbols and abbreviations.

**WATER LEVEL OBSERVATIONS**

Groundwater not encountered



1355 E Cooley Dr, Ste C  
Colton, CA

Boring Started: 10-14-2021

Boring Completed: 10-14-2021

Drill Rig: CME 75

Driller: Martini Drilling

Project No.: CB205038

THIS BORING LOG IS NOT VALID IF SEPARATED FROM ORIGINAL REPORT. GEO SMART LOG-NO WELL CB205038 PROPOSED RESIDENT.GPJ TERRACON.DATATEMPLATE.GDT 11/29/21



# BORING LOG NO. B-9

**PROJECT:** Proposed Residential Development

**CLIENT:** Perris at Pentecostal LLC  
Irvine, CA

**SITE:** Perris Boulevard & Santiago Drive  
Moreno Valley

GRAPHIC LOG	LOCATION See <a href="#">Exploration Plan</a> Latitude: 33.8904° Longitude: -117.2290°	DEPTH (FL)	WATER LEVEL OBSERVATIONS	SAMPLE TYPE	FIELD TEST RESULTS	WATER CONTENT (%)	DRY UNIT WEIGHT (pcf)	ATTERBERG LIMITS LL-PL-PI	PERCENT FINES
DEPTH									
30.0	<b>SILTY SAND (SM)</b> , trace clay, fine to coarse grained, brown, medium dense <i>(continued)</i>	30							
31.5	<b>POORLY GRADED SAND WITH SILT (SP-SM)</b> , trace gravel up to 1/4", fine to coarse grained, light brown, medium dense			X	7-9-10 N=19				
	<b>Boring Terminated at 31.5 Feet</b>								

Stratification lines are approximate. In-situ, the transition may be gradual.

Hammer Type: Automatic (79.3%)

Advancement Method:  
6" Hollow-Stem Auger

See [Exploration and Testing Procedures](#) for a description of field and laboratory procedures used and additional data (if any).

Notes:

Abandonment Method:  
Boring backfilled with auger cuttings upon completion.

See [Supporting Information](#) for explanation of symbols and abbreviations.

**WATER LEVEL OBSERVATIONS**

*Groundwater not encountered*



Boring Started: 10-14-2021

Boring Completed: 10-14-2021

Drill Rig: CME 75

Driller: Martini Drilling

Project No.: CB205038

THIS BORING LOG IS NOT VALID IF SEPARATED FROM ORIGINAL REPORT. GEO SMART LOG-NO WELL CB205038 PROPOSED RESIDENT.GPJ TERRACON\_DATATEMPLATE.GDT 11/29/21

# BORING LOG NO. B-10

**PROJECT:** Proposed Residential Development

**CLIENT:** Perris at Pentecostal LLC  
Irvine, CA

**SITE:** Perris Boulevard & Santiago Drive  
Moreno Valley

GRAPHIC LOG	LOCATION See <a href="#">Exploration Plan</a> Latitude: 33.8901° Longitude: -117.2295°	DEPTH (FL)	WATER LEVEL OBSERVATIONS	SAMPLE TYPE	FIELD TEST RESULTS	WATER CONTENT (%)	DRY UNIT WEIGHT (pcf)	ATTERBERG LIMITS	
								LL-PL-PI	PERCENT FINES
DEPTH									
	<b>SILTY SAND (SM)</b> , trace gravel up to 1/4", fine to coarse grained, yellowish brown, loose								
		5		X	4-5-8	3.0	102	NP	33
	medium dense			X	8-21-25	5.0	111		
	medium to coarse grained loose			X	3-5-9	3.9	103		
	fine to coarse grained, medium dense	10		X	4-9-14	3.1	111		
		15		X	5-10-12 N=22				
		20		X	3-5-8 N=13				
	<b>SANDY LEAN CLAY (CL)</b> , brown, stiff								
	<b>Boring Terminated at 21.5 Feet</b>								

Stratification lines are approximate. In-situ, the transition may be gradual.

Hammer Type: Automatic (79.3%)

Advancement Method:  
6" Hollow-Stem Auger

See [Exploration and Testing Procedures](#) for a description of field and laboratory procedures used and additional data (if any).

Notes:

Abandonment Method:  
Boring backfilled with auger cuttings upon completion.

See [Supporting Information](#) for explanation of symbols and abbreviations.

**WATER LEVEL OBSERVATIONS**

Groundwater not encountered



1355 E Cooley Dr, Ste C  
Colton, CA

Boring Started: 10-14-2021

Boring Completed: 10-14-2021

Drill Rig: CME 75

Driller: Martini Drilling

Project No.: CB205038

THIS BORING LOG IS NOT VALID IF SEPARATED FROM ORIGINAL REPORT. GEO SMART LOG-NO WELL CB205038 PROPOSED RESIDENT.GPJ TERRACON\_DATATEMPLATE.GDT 11/29/21

# BORING LOG NO. B-11

**PROJECT:** Proposed Residential Development

**CLIENT:** Perris at Pentecostal LLC  
Irvine, CA

**SITE:** Perris Boulevard & Santiago Drive  
Moreno Valley

THIS BORING LOG IS NOT VALID IF SEPARATED FROM ORIGINAL REPORT. GEO SMART LOG-NO WELL CB205038 PROPOSED RESIDENT.GPJ TERRACON\_DATATEMPLATE.GDT 11/29/21

GRAPHIC LOG	LOCATION See <a href="#">Exploration Plan</a> Latitude: 33.8901° Longitude: -117.2290°	DEPTH (FL)	WATER LEVEL OBSERVATIONS	SAMPLE TYPE	FIELD TEST RESULTS	WATER CONTENT (%)	DRY UNIT WEIGHT (pcf)	ATTERBERG LIMITS	PERCENT FINES
								LL-PL-PI	
	<b>SILTY SAND (SM)</b> , trace clay, fine to coarse grained, brown, loose								
		5		X	3-4-4	4.2	111		42
				X	3-5-9	4.3	108		20
	<b>POORLY GRADED SAND WITH SILT (SP-SM)</b> , trace gravel up to 1/4", fine to coarse grained, grayish brown, loose								
	medium dense	10		X	4-7-11	0.7	108		5
				X	5-11-13	1.0			6
	<b>SILTY SAND (SM)</b> , trace gravel up to 1/4", fine grained, brown, medium dense								
		15		X	7-12-13 N=25				16
	<b>SANDY LEAN CLAY (CL)</b> , fine to coarse grained, brown, stiff								
		20		X	3-5-6 N=11				53
	<b>Boring Terminated at 21.5 Feet</b>								

Stratification lines are approximate. In-situ, the transition may be gradual.

Hammer Type: Automatic (79.3%)

Advancement Method:  
6" Hollow-Stem Auger

See [Exploration and Testing Procedures](#) for a description of field and laboratory procedures used and additional data (if any).

Notes:

Abandonment Method:  
Boring backfilled with auger cuttings upon completion.

See [Supporting Information](#) for explanation of symbols and abbreviations.

**WATER LEVEL OBSERVATIONS**

Groundwater not encountered



Boring Started: 10-14-2021

Boring Completed: 10-14-2021

Drill Rig: CME 75

Driller: Martini Drilling

Project No.: CB205038

# BORING LOG NO. B-12

**PROJECT:** Proposed Residential Development

**CLIENT:** Perris at Pentecostal LLC  
Irvine, CA

**SITE:** Perris Boulevard & Santiago Drive  
Moreno Valley

GRAPHIC LOG	LOCATION See <a href="#">Exploration Plan</a> Latitude: 33.8897° Longitude: -117.2302°	DEPTH (FL)	WATER LEVEL OBSERVATIONS	SAMPLE TYPE	FIELD TEST RESULTS	WATER CONTENT (%)	DRY UNIT WEIGHT (pcf)	ATTERBERG LIMITS	PERCENT FINES
								LL-PL-PI	
	DEPTH								
	<p><b>SILTY SAND (SM)</b>, trace gravel up to 1", fine to coarse grained, yellowish brown, loose</p>	<p>5</p>			<p>5-5-4</p>	<p>3.6</p>	<p>102</p>		
	<p>trace clay, fine to medium grained, medium dense</p>	<p>10</p>			<p>2-3-6</p>	<p>5.4</p>	<p>108</p>		
		<p>15</p>			<p>5-8-11</p>	<p>4.8</p>	<p>112</p>		
		<p>20</p>			<p>5-8-10</p>	<p>4.1</p>	<p>113</p>		
		<p>20.0</p>			<p>4-5-8 N=13</p>				
	<p><b>SANDY LEAN CLAY (CL)</b>, fine to medium grained, brown, stiff</p>	<p>21.5</p>			<p>5-5-7 N=12</p>				
	<p><b>Boring Terminated at 21.5 Feet</b></p>								

Stratification lines are approximate. In-situ, the transition may be gradual.

Hammer Type: Automatic (79.3%)

Advancement Method:  
6" Hollow-Stem Auger

See [Exploration and Testing Procedures](#) for a description of field and laboratory procedures used and additional data (if any).

Notes:

Abandonment Method:  
Boring backfilled with auger cuttings upon completion.

See [Supporting Information](#) for explanation of symbols and abbreviations.

**WATER LEVEL OBSERVATIONS**

Groundwater not encountered



Boring Started: 10-14-2021

Boring Completed: 10-14-2021

Drill Rig: CME 75

Driller: Martini Drilling

Project No.: CB205038

THIS BORING LOG IS NOT VALID IF SEPARATED FROM ORIGINAL REPORT. GEO SMART LOG-NO WELL CB205038 PROPOSED RESIDENT.GPJ TERRACON\_DATATEMPLATE.GDT 11/29/21

# BORING LOG NO. B-13

**PROJECT:** Proposed Residential Development

**CLIENT:** Perris at Pentecostal LLC  
Irvine, CA

**SITE:** Perris Boulevard & Santiago Drive  
Moreno Valley

GRAPHIC LOG	LOCATION See <a href="#">Exploration Plan</a> Latitude: 33.8898° Longitude: -117.2295°	DEPTH (FL)	WATER LEVEL OBSERVATIONS	SAMPLE TYPE	FIELD TEST RESULTS	WATER CONTENT (%)	DRY UNIT WEIGHT (pcf)	ATTERBERG LIMITS	
								LL-PL-PI	PERCENT FINES
	<b>SILTY SAND (SM)</b> , trace gravel up to 1/4", fine to coarse grained, yellowish brown, very loose								
	fine to medium grained	5		X	3-2-2	3.1	91	NP	34 29
	loose			X	2-3-5	2.9	102		19
	trace clay medium dense			X	5-10-14	4.9	112		35
		10		X	6-9-11	4.4	106		30
		15		X	6-9-8 N=17				29
	no clay, fine to coarse grained, dark brown	20		X	5-9-10 N=19				34
		25		X	6-9-8 N=17				40

Stratification lines are approximate. In-situ, the transition may be gradual.

Hammer Type: Automatic (79.3%)

Advancement Method:  
6" Hollow-Stem Auger

See [Exploration and Testing Procedures](#) for a description of field and laboratory procedures used and additional data (if any).

Notes:

Abandonment Method:  
Boring backfilled with auger cuttings upon completion.

See [Supporting Information](#) for explanation of symbols and abbreviations.

**WATER LEVEL OBSERVATIONS**

- While drilling
- After 15 minutes



Boring Started: 10-14-2021

Boring Completed: 10-14-2021

Drill Rig: CME 75

Driller: Martini Drilling

Project No.: CB205038

THIS BORING LOG IS NOT VALID IF SEPARATED FROM ORIGINAL REPORT. GEO SMART LOG-NO WELL CB205038 PROPOSED RESIDENT.GPJ TERRACON\_DATATEMPLATE.GDT 11/29/21

# BORING LOG NO. B-13

**PROJECT:** Proposed Residential Development

**CLIENT:** Perris at Pentecostal LLC  
Irvine, CA

**SITE:** Perris Boulevard & Santiago Drive  
Moreno Valley

GRAPHIC LOG	LOCATION See <a href="#">Exploration Plan</a> Latitude: 33.8898° Longitude: -117.2295°	DEPTH (FL)	WATER LEVEL OBSERVATIONS	SAMPLE TYPE	FIELD TEST RESULTS	WATER CONTENT (%)	DRY UNIT WEIGHT (pcf)	ATTERBERG LIMITS	PERCENT FINES
								LL-PL-PI	
	DEPTH								
●●●●●	<b>SILTY SAND (SM)</b> , trace gravel up to 1/4", fine to coarse grained, yellowish brown, very loose ( <i>continued</i> )	30		X	6-9-10 N=19				33
●●●●●		35		X	7-8-8 N=16				18
●●●●●	trace clay	40	▽	X	8-8-11 N=19				17
●●●●●		45		X	3-4-6 N=10				70
●●●●●	<b>SANDY LEAN CLAY (CL)</b> , dark brown, stiff	48.0							
●●●●●	<b>SILTY SAND (SM)</b> , dark brown, medium dense	50		X	5-8-12 N=20				43
●●●●●	<b>Boring Terminated at 51.5 Feet</b>	51.5							

Stratification lines are approximate. In-situ, the transition may be gradual.

Hammer Type: Automatic (79.3%)

Advancement Method:  
6" Hollow-Stem Auger

See [Exploration and Testing Procedures](#) for a description of field and laboratory procedures used and additional data (if any).

Notes:

Abandonment Method:  
Boring backfilled with auger cuttings upon completion.

See [Supporting Information](#) for explanation of symbols and abbreviations.

**WATER LEVEL OBSERVATIONS**

- ▽ While drilling
- ▽ After 15 minutes



Boring Started: 10-14-2021

Boring Completed: 10-14-2021

Drill Rig: CME 75

Driller: Martini Drilling

Project No.: CB205038

THIS BORING LOG IS NOT VALID IF SEPARATED FROM ORIGINAL REPORT. GEO SMART LOG-NO WELL CB205038 PROPOSED RESIDENT.GPJ TERRACON\_DATATEMPLATE.GDT 11/29/21



# BORING LOG NO. B-14

**PROJECT:** Proposed Residential Development

**CLIENT:** Perris at Pentecostal LLC  
Irvine, CA

**SITE:** Perris Boulevard & Santiago Drive  
Moreno Valley

THIS BORING LOG IS NOT VALID IF SEPARATED FROM ORIGINAL REPORT. GEO SMART LOG-NO WELL CB205038 PROPOSED RESIDENT.GPJ TERRACON\_DATATEMPLATE.GDT 11/29/21

GRAPHIC LOG	LOCATION See <a href="#">Exploration Plan</a> Latitude: 33.8897° Longitude: -117.2289°	DEPTH (FL)	WATER LEVEL OBSERVATIONS	SAMPLE TYPE	FIELD TEST RESULTS	WATER CONTENT (%)	DRY UNIT WEIGHT (pcf)	ATTERBERG LIMITS		PERCENT FINES
								LL-PL-PI		
DEPTH										
0.0	<b>SILTY SAND (SM)</b> , trace gravel up to 1/4", fine to coarse grained, yellowish brown, loose									
7.0	medium dense	5		X	3-3-4	2.3	99			
10.0	<b>POORLY GRADED SAND WITH SILT (SP-SM)</b> , trace gravel up to 1/4", fine to coarse grained, grayish brown, loose									
15.0	medium dense	10		X	4-7-9	0.5				
20.0	<b>SILTY SAND (SM)</b> , trace gravel up to 1/4", fine grained, brown, medium dense									
21.5	<b>SANDY LEAN CLAY (CL)</b> , fine to coarse grained, brown, stiff	15		X	7-8-10 N=18					
21.5	<b>Boring Terminated at 21.5 Feet</b>	20		X	3-6-8 N=14					

Stratification lines are approximate. In-situ, the transition may be gradual.

Hammer Type: Automatic (79.3%)

Advancement Method:  
6" Hollow-Stem Auger

See [Exploration and Testing Procedures](#) for a description of field and laboratory procedures used and additional data (if any).

Notes:

Abandonment Method:  
Boring backfilled with auger cuttings upon completion.

See [Supporting Information](#) for explanation of symbols and abbreviations.

**WATER LEVEL OBSERVATIONS**

Groundwater not encountered



Boring Started: 10-14-2021

Boring Completed: 10-14-2021

Drill Rig: CME 75

Driller: Martini Drilling

Project No.: CB205038

# BORING LOG NO. B-15

**PROJECT:** Proposed Residential Development

**CLIENT:** Perris at Pentecostal LLC  
Irvine, CA

**SITE:** Perris Boulevard & Santiago Drive  
Moreno Valley

GRAPHIC LOG	LOCATION See <a href="#">Exploration Plan</a> Latitude: 33.8894° Longitude: -117.2296°	DEPTH (FL)	WATER LEVEL OBSERVATIONS	SAMPLE TYPE	FIELD TEST RESULTS	WATER CONTENT (%)	DRY UNIT WEIGHT (pcf)	ATTERBERG LIMITS	PERCENT FINES
								LL-PL-PI	
DEPTH									
	<b>SILTY SAND (SM)</b> , trace clay, trace gravel up to 1/4", fine to medium grained, yellowish brown, loose								
		5		X	5-6-7	3.8	114		
				X	3-4-7	5.5	106		
				X	4-6-7	8.6	107		
	6" lens of coarse sand with gravel	10		X	2-5-8	0.8	104		
				X	3-5-6 N=11				
	medium dense	15		X					
		20		X	4-5-9 N=14				
	20.0								
	<b>SANDY LEAN CLAY (CL)</b> , fine to coarse grained, dark brown, stiff	21.5							
	<b>Boring Terminated at 21.5 Feet</b>								

Stratification lines are approximate. In-situ, the transition may be gradual.

Hammer Type: Automatic (79.3%)

Advancement Method:  
6" Hollow-Stem Auger

See [Exploration and Testing Procedures](#) for a description of field and laboratory procedures used and additional data (if any).

Notes:

Abandonment Method:  
Boring backfilled with auger cuttings upon completion.

See [Supporting Information](#) for explanation of symbols and abbreviations.

**WATER LEVEL OBSERVATIONS**

Groundwater not encountered



1355 E Cooley Dr, Ste C  
Colton, CA

Boring Started: 10-14-2021

Boring Completed: 10-14-2021

Drill Rig: CME 75

Driller: Martini Drilling

Project No.: CB205038

THIS BORING LOG IS NOT VALID IF SEPARATED FROM ORIGINAL REPORT. GEO SMART LOG-NO WELL CB205038 PROPOSED RESIDENT.GPJ TERRACON\_DATATEMPLATE.GDT 11/29/21

# BORING LOG NO. B-16

**PROJECT:** Proposed Residential Development

**CLIENT:** Perris at Pentecostal LLC  
Irvine, CA

**SITE:** Perris Boulevard & Santiago Drive  
Moreno Valley

THIS BORING LOG IS NOT VALID IF SEPARATED FROM ORIGINAL REPORT. GEO SMART LOG-NO WELL CB205038 PROPOSED RESIDENT.GPJ TERRACON.DATATEMPLATE.GDT 11/29/21

GRAPHIC LOG	LOCATION See <a href="#">Exploration Plan</a> Latitude: 33.8895° Longitude: -117.2290°	DEPTH (FL)	WATER LEVEL OBSERVATIONS	SAMPLE TYPE	FIELD TEST RESULTS	WATER CONTENT (%)	DRY UNIT WEIGHT (pcf)	ATTERBERG LIMITS	PERCENT FINES
								LL-PL-PI	
DEPTH									
7.0	<b>SILTY SAND (SM)</b> , trace gravel up to 1/4", fine grained, brown, loose	5		X	4-5-6	2.7	103		
10.0	<b>POORLY GRADED SAND WITH SILT (SP-SM)</b> , trace gravel up to 1/4", fine to coarse grained, grayish brown, loose	7.0		X	4-6-6	4.3	99		
20.0	<b>SILTY SAND (SM)</b> , trace gravel up to 1/4", fine grained, brown, medium dense	10		X	3-6-10	2.5	111		
21.5	<b>SANDY LEAN CLAY (CL)</b> , fine to coarse grained, brown, stiff	15		X	7-14-16	5.9	109		
21.5	<b>Boring Terminated at 21.5 Feet</b>	20		X	6-9-9 N=18				
21.5		20		X	3-4-7 N=11				

Stratification lines are approximate. In-situ, the transition may be gradual.

Hammer Type: Automatic (79.3%)

Advancement Method:  
6" Hollow-Stem Auger

See [Exploration and Testing Procedures](#) for a description of field and laboratory procedures used and additional data (if any).

Notes:

Abandonment Method:  
Boring backfilled with auger cuttings upon completion.

See [Supporting Information](#) for explanation of symbols and abbreviations.

**WATER LEVEL OBSERVATIONS**

Groundwater not encountered



Boring Started: 10-14-2021

Boring Completed: 10-14-2021

Drill Rig: CME 75

Driller: Martini Drilling

Project No.: CB205038

# BORING LOG NO. B-17

**PROJECT:** Proposed Residential Development

**CLIENT:** Perris at Pentecostal LLC  
Irvine, CA

**SITE:** Perris Boulevard & Santiago Drive  
Moreno Valley

GRAPHIC LOG	LOCATION See <a href="#">Exploration Plan</a> Latitude: 33.8892° Longitude: -117.2302°	DEPTH (FL)	WATER LEVEL OBSERVATIONS	SAMPLE TYPE	FIELD TEST RESULTS	WATER CONTENT (%)	DRY UNIT WEIGHT (pcf)	ATTERBERG LIMITS	PERCENT FINES
								LL-PL-PI	
	<b>SILTY SAND (SM)</b> , trace clay, trace gravel 1/4", fine to medium grained, yellowish brown, very loose								
		5			5-5-4	6.5	102		43
	no clay loose				3-3-2	7.4	99		48
		10			2-4-7	3.8	106		35
					4-7-10	3.2	101		29
	medium dense	15			6-11-12 N=23				46
	trace clay, fine to coarse grained	20			7-10-11 N=21				46
	calcium carbonate	25			3-6-5 N=11				41

Stratification lines are approximate. In-situ, the transition may be gradual.

Hammer Type: Automatic (79.3%)

Advancement Method:  
6" Hollow-Stem Auger

See [Exploration and Testing Procedures](#) for a description of field and laboratory procedures used and additional data (if any).

Notes:

Abandonment Method:  
Boring backfilled with auger cuttings upon completion.

See [Supporting Information](#) for explanation of symbols and abbreviations.

**WATER LEVEL OBSERVATIONS**

Groundwater not encountered



Boring Started: 10-14-2021

Boring Completed: 10-14-2021

Drill Rig: CME 75

Driller: Martini Drilling

Project No.: CB205038

THIS BORING LOG IS NOT VALID IF SEPARATED FROM ORIGINAL REPORT. GEO SMART LOG-NO WELL CB205038 PROPOSED RESIDENT.GPJ TERRACON\_DATATEMPLATE.GDT 11/29/21

# BORING LOG NO. B-17

**PROJECT:** Proposed Residential Development

**CLIENT:** Perris at Pentecostal LLC  
Irvine, CA

**SITE:** Perris Boulevard & Santiago Drive  
Moreno Valley

GRAPHIC LOG	LOCATION See <a href="#">Exploration Plan</a> Latitude: 33.8892° Longitude: -117.2302°	DEPTH (FL)	WATER LEVEL OBSERVATIONS	SAMPLE TYPE	FIELD TEST RESULTS	WATER CONTENT (%)	DRY UNIT WEIGHT (pcf)	ATTERBERG LIMITS	PERCENT FINES
								LL-PL-PI	
DEPTH									
31.5	<b>SILTY SAND (SM)</b> , trace clay, trace gravel 1/4", fine to medium grained, yellowish brown, very loose ( <i>continued</i> )	30		X	5-6-7 N=13				43
	<i>fine grained</i>								
	<b>Boring Terminated at 31.5 Feet</b>								

Stratification lines are approximate. In-situ, the transition may be gradual.

Hammer Type: Automatic (79.3%)

Advancement Method:  
6" Hollow-Stem Auger

See [Exploration and Testing Procedures](#) for a description of field and laboratory procedures used and additional data (if any).

Notes:

Abandonment Method:  
Boring backfilled with auger cuttings upon completion.

See [Supporting Information](#) for explanation of symbols and abbreviations.

**WATER LEVEL OBSERVATIONS**

*Groundwater not encountered*



Boring Started: 10-14-2021

Boring Completed: 10-14-2021

Drill Rig: CME 75

Driller: Martini Drilling

Project No.: CB205038

THIS BORING LOG IS NOT VALID IF SEPARATED FROM ORIGINAL REPORT. GEO SMART LOG-NO WELL CB205038 PROPOSED RESIDENT.GPJ TERRACON\_DATATEMPLATE.GDT 11/29/21

# BORING LOG NO. B-18

**PROJECT:** Proposed Residential Development

**CLIENT:** Perris at Pentecostal LLC  
Irvine, CA

**SITE:** Perris Boulevard & Santiago Drive  
Moreno Valley

THIS BORING LOG IS NOT VALID IF SEPARATED FROM ORIGINAL REPORT. GEO SMART LOG-NO WELL CB205038 PROPOSED RESIDENT.GPJ TERRACON\_DATATEMPLATE.GDT 11/29/21

GRAPHIC LOG	LOCATION See <a href="#">Exploration Plan</a> Latitude: 33.8888° Longitude: -117.2295°	DEPTH (FL)	WATER LEVEL OBSERVATIONS	SAMPLE TYPE	FIELD TEST RESULTS	WATER CONTENT (%)	DRY UNIT WEIGHT (pcf)	ATTERBERG LIMITS	
								LL-PL-PI	PERCENT FINES
DEPTH									
4.0	<b>SILTY SAND (SM)</b> , fine grained, brown, loose				4-5-6	4.8	109	NP	38
5	<b>SANDY LEAN CLAY (CL)</b> , dark brown, stiff				2-7-9	8.2	113		
9.5	<b>SILTY SAND (SM)</b> , fine to medium grained, brown, loose  coarse sand lens at 11'				5-8-10	8.5	110		
15.5	<b>SANDY LEAN CLAY (CL)</b> , brown, stiff				5-7-7 N=14				
21.5	very stiff				7-12-16 N=28				
	<b>Boring Terminated at 21.5 Feet</b>								

Stratification lines are approximate. In-situ, the transition may be gradual.

Hammer Type: Automatic (79.3%)

Advancement Method:  
6" Hollow-Stem Auger

See [Exploration and Testing Procedures](#) for a description of field and laboratory procedures used and additional data (if any).

Notes:

Abandonment Method:  
Boring backfilled with auger cuttings upon completion.

See [Supporting Information](#) for explanation of symbols and abbreviations.

**WATER LEVEL OBSERVATIONS**

Groundwater not encountered



Boring Started: 10-15-2021

Boring Completed: 10-15-2021

Drill Rig: CME 75

Driller: Martini Drilling

Project No.: CB205038



# GRAIN SIZE DISTRIBUTION

## ASTM D422 / ASTM C136

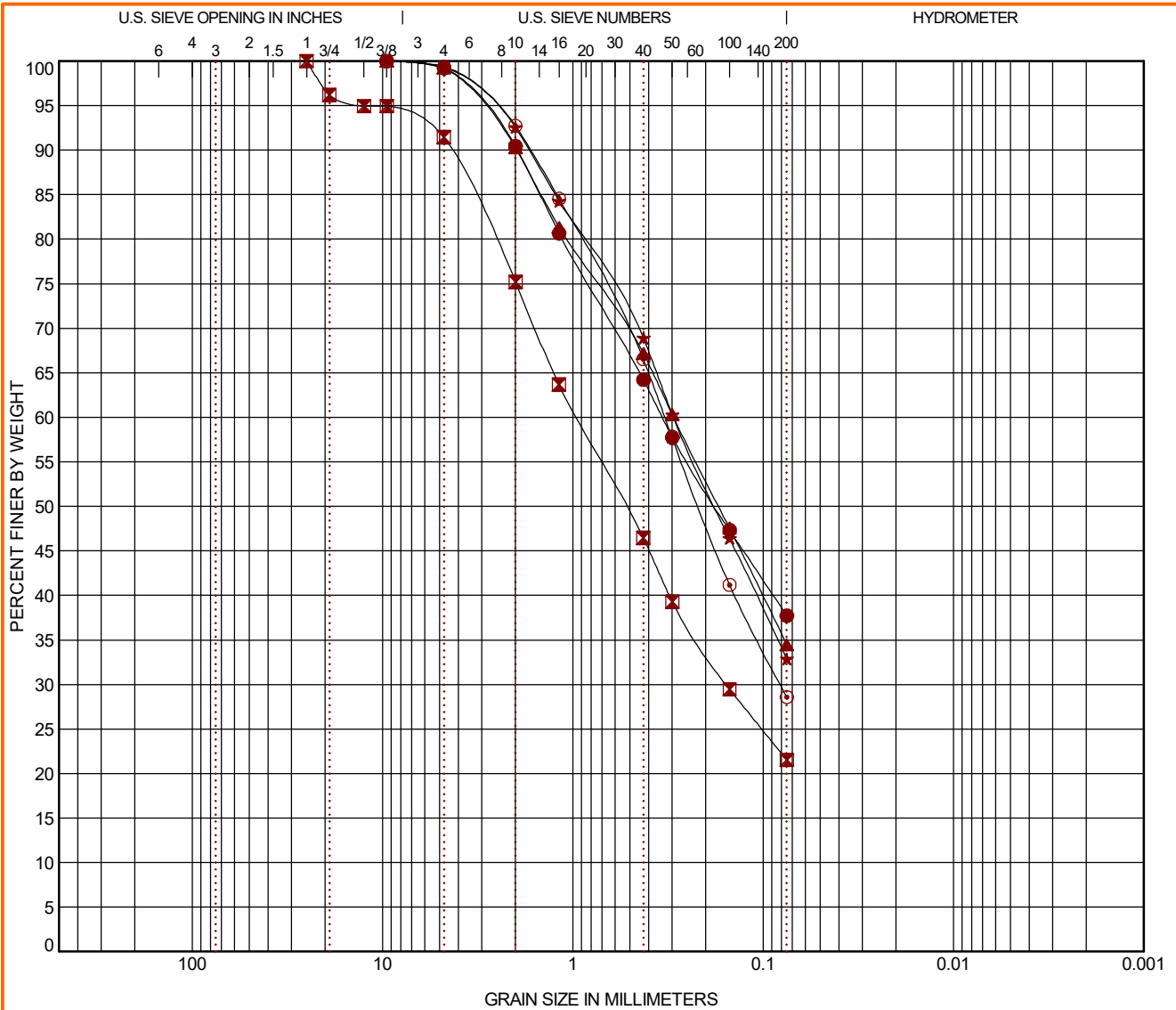

COBBLES	GRAVEL		SAND			SILT OR CLAY
	coarse	fine	coarse	medium	fine	

Boring ID	Depth	USCS Classification				WC (%)	LL	PL	PI	Cc	Cu
● B-1	0 - 5	SILTY SAND (SM)					NP	NP	NP		
☒ B-3	0 - 5	SILTY SAND (SM)					NP	NP	NP		
▲ B-8	0 - 5	SILTY SAND (SM)					NP	NP	NP		
★ B-10	2 - 5	SILTY SAND (SM)					NP	NP	NP		
⊙ B-13	2 - 5	SILTY SAND (SM)					NP	NP	NP		

Boring ID	Depth	D <sub>100</sub>	D <sub>60</sub>	D <sub>30</sub>	D <sub>10</sub>	%Cobbles	%Gravel	%Sand	%Silt	%Fines	%Clay
● B-1	0 - 5	9.5	0.338			0.0	0.8	61.5		37.7	
☒ B-3	0 - 5	25	0.95	0.156		0.0	8.6	69.9		21.5	
▲ B-8	0 - 5	9.5	0.295			0.0	0.8	64.7		34.4	
★ B-10	2 - 5	9.5	0.296			0.0	0.7	66.4		32.9	
⊙ B-13	2 - 5	9.5	0.329	0.081		0.0	0.6	70.8		28.6	

PROJECT: Proposed Residential Development

SITE: Perris Boulevard & Santiago Drive  
Moreno Valley



PROJECT NUMBER: CB205038

CLIENT: Perris at Pentecostal LLC  
Irvine, CA

LABORATORY TESTS ARE NOT VALID IF SEPARATED FROM ORIGINAL REPORT. GRAIN SIZE: USCS-2 CB205038 PROPOSED RESIDENT.GPJ TERRACON\_DATATEMPLATE.GDT 11/24/21

# GRAIN SIZE DISTRIBUTION

## ASTM D422 / ASTM C136

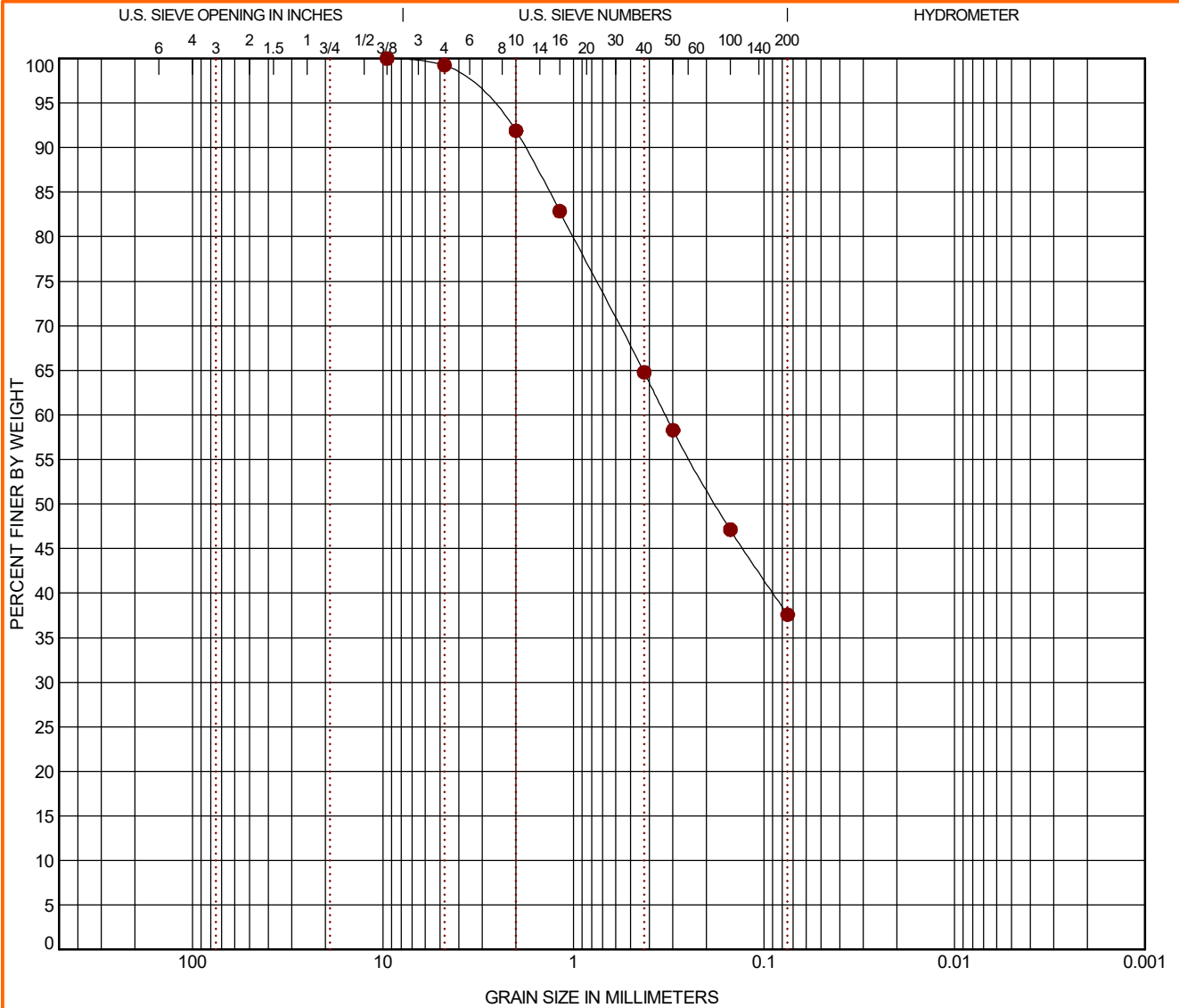

<b>COBBLES</b>	<b>GRAVEL</b>		<b>SAND</b>			<b>SILT OR CLAY</b>
	coarse	fine	coarse	medium	fine	

Boring ID	Depth	USCS Classification	WC (%)	LL	PL	PI	Cc	Cu
● B-18	0 - 5	SILTY SAND (SM)		NP	NP	NP		

Boring ID	Depth	D <sub>100</sub>	D <sub>60</sub>	D <sub>30</sub>	D <sub>10</sub>	%Cobbles	%Gravel	%Sand	%Silt	%Fines	%Clay
● B-18	0 - 5	9.5	0.329			0.0	0.8	61.7		37.6	

LABORATORY TESTS ARE NOT VALID IF SEPARATED FROM ORIGINAL REPORT. GRAIN SIZE: USCS-2 CB205038 PROPOSED RESIDENT.GPJ TERRACON\_DATATEMPLATE.GDT 11/24/21

PROJECT: Proposed Residential Development	<p style="font-size: small;">1355 E Cooley Dr, Ste C Colton, CA</p>	PROJECT NUMBER: CB205038
SITE: Perris Boulevard & Santiago Drive Moreno Valley		CLIENT: Perris at Pentecostal LLC Irvine, CA

# SWELL CONSOLIDATION TEST

ASTM D2435

LABORATORY TESTS ARE NOT VALID IF SEPARATED FROM ORIGINAL REPORT. TC\_CONSOL\_STRAIN-USCS CB205038 PROPOSED RESIDENT.GPJ TERRACON\_DATATEMPLATE.GDT 11/24/21

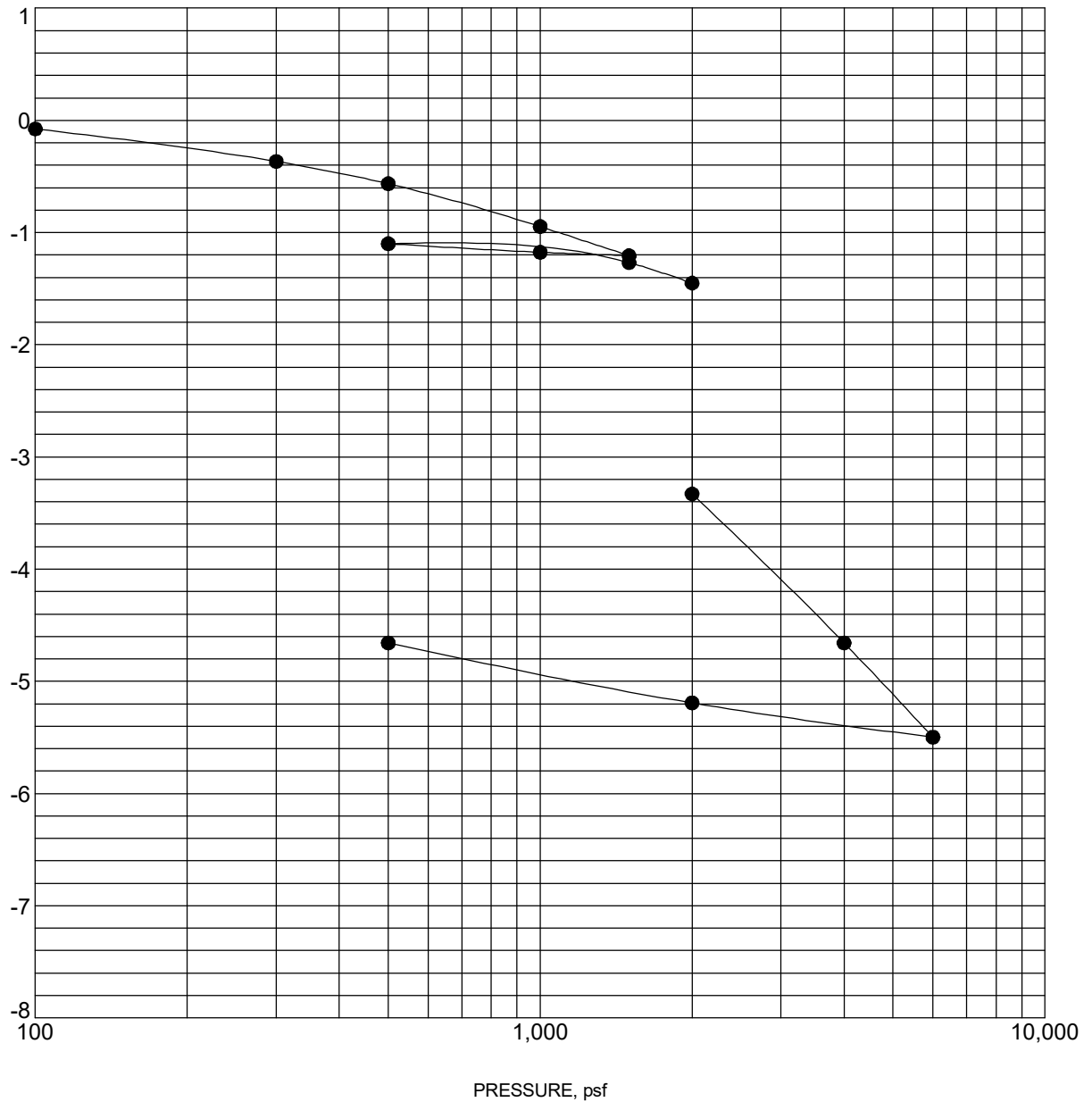

Specimen Identification			Classification	$\gamma_d$ , pcf	WC, %
○	B-2	5 - 6.5 ft	Silty Sand (SM)	109	5.1

NOTES:

PROJECT: Proposed Residential Development



PROJECT NUMBER: CB205038

SITE: Perris Boulevard & Santiago Drive  
Moreno Valley

CLIENT: Perris at Pentecostal LLC  
Irvine, CA

# SWELL CONSOLIDATION TEST

ASTM D2435

LABORATORY TESTS ARE NOT VALID IF SEPARATED FROM ORIGINAL REPORT. TC\_CONSOL\_STRAIN-USCS CB205038 PROPOSED RESIDENT.GPJ TERRACON\_DATATEMPLATE.GDT 11/24/21

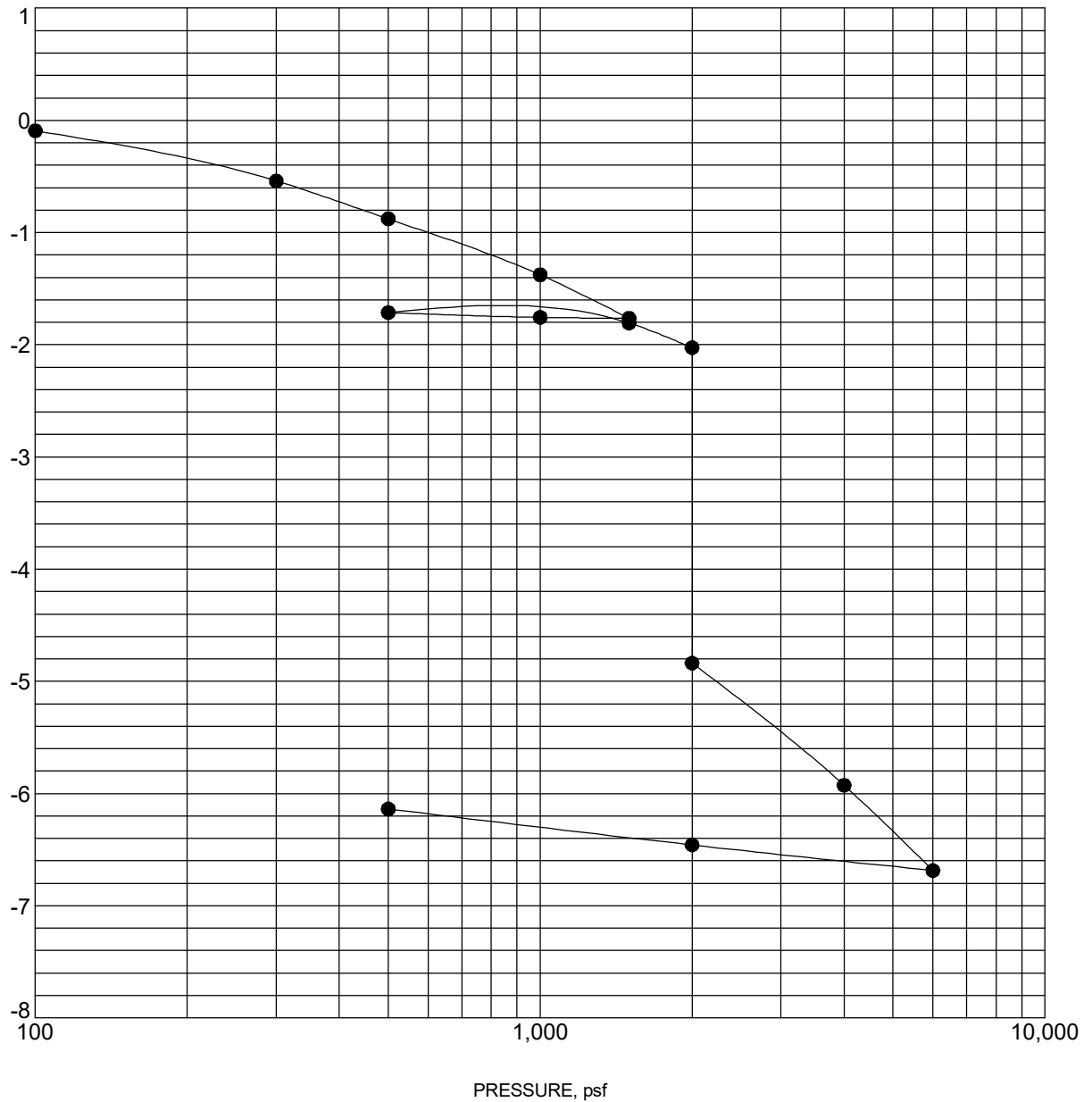

Specimen Identification		Classification	$\gamma_d$ , pcf	WC, %
○	B-6 5 - 6.5 ft	Silty Sand (SM)	105	2.3

NOTES:

PROJECT: Proposed Residential Development



PROJECT NUMBER: CB205038

SITE: Perris Boulevard & Santiago Drive  
Moreno Valley

CLIENT: Perris at Pentecostal LLC  
Irvine, CA

# SWELL CONSOLIDATION TEST

ASTM D2435

LABORATORY TESTS ARE NOT VALID IF SEPARATED FROM ORIGINAL REPORT. TC\_CONSOL\_STRAIN-USCS CB205038 PROPOSED RESIDENT.GPJ TERRACON\_DATATEMPLATE.GDT 11/24/21

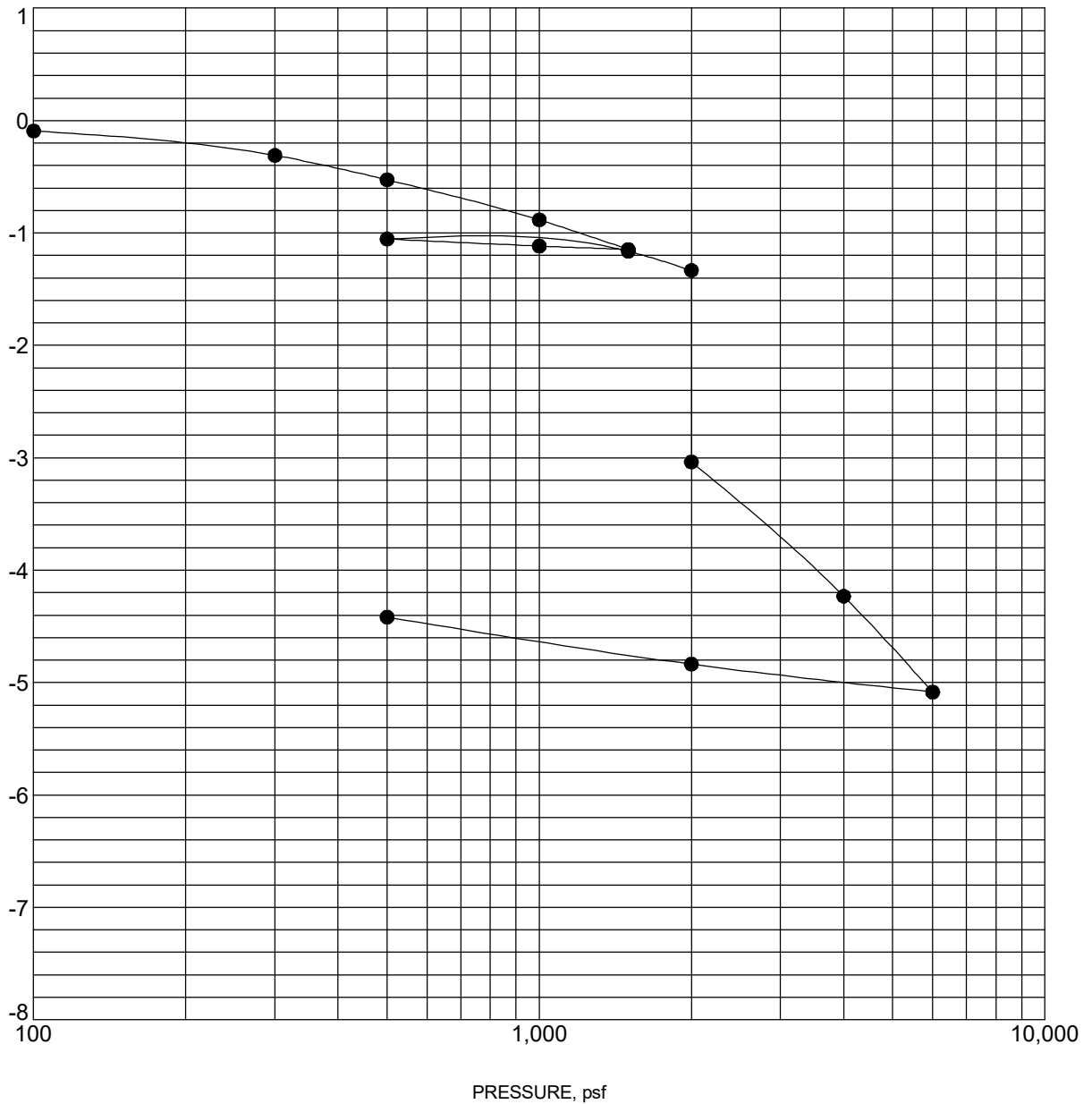

Specimen Identification		Classification	$\gamma_d$ , pcf	WC, %
○	B-13 5 - 6.5 ft	Silty Sand (SM)	100	3.2

NOTES:

PROJECT: Proposed Residential Development



PROJECT NUMBER: CB205038

SITE: Perris Boulevard & Santiago Drive  
Moreno Valley

CLIENT: Perris at Pentecostal LLC  
Irvine, CA

# SWELL CONSOLIDATION TEST

ASTM D2435

LABORATORY TESTS ARE NOT VALID IF SEPARATED FROM ORIGINAL REPORT. TC\_CONSOL\_STRAIN-USCS CB205038 PROPOSED RESIDENT.GPJ TERRACON\_DATATEMPLATE.GDT 11/24/21

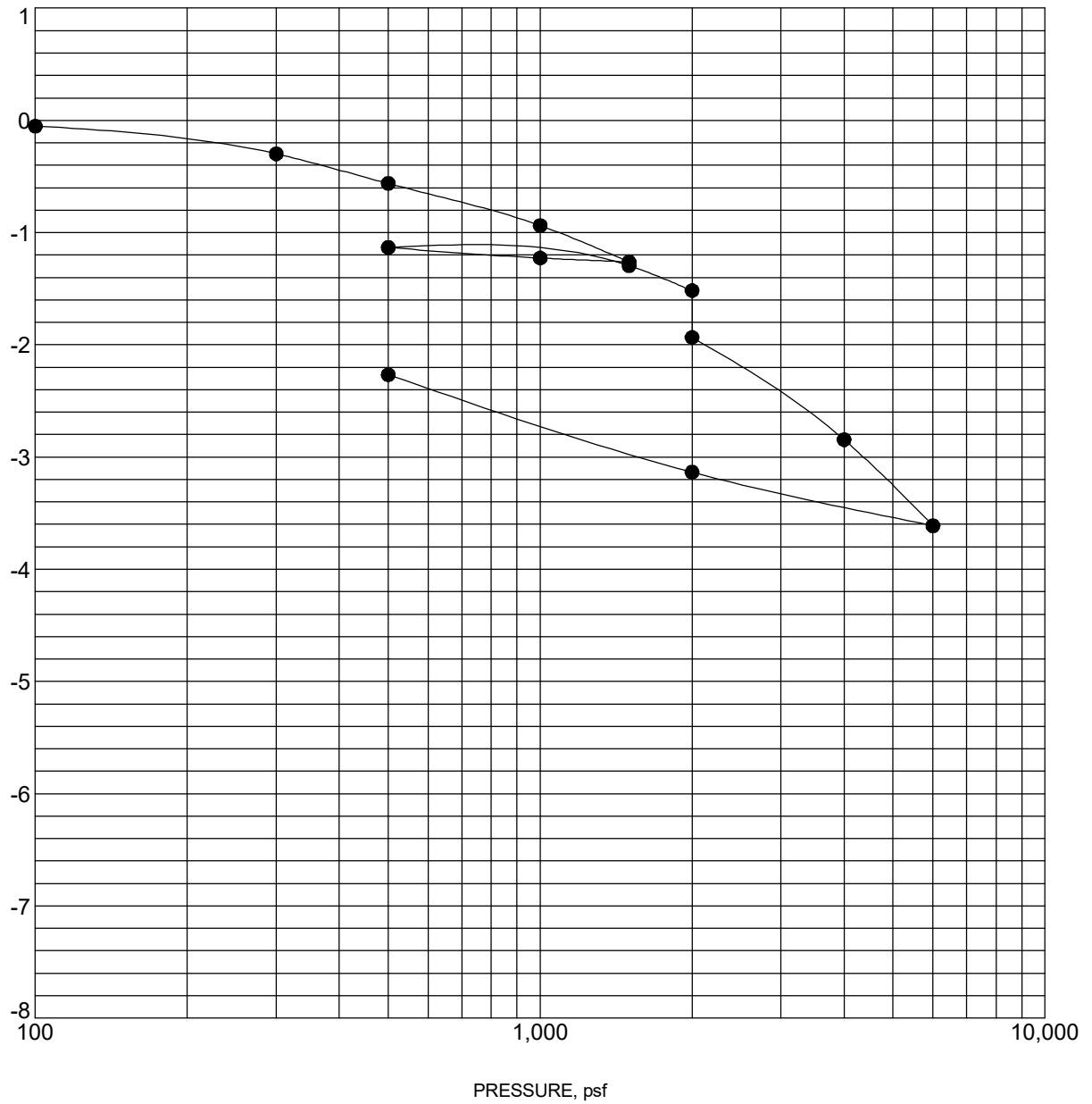

Specimen Identification			Classification	$\gamma_d$ , pcf	WC, %
○	B-15	7.5 - 9 ft	Silty Sand (SM)	105	8.9

NOTES:

PROJECT: Proposed Residential Development



PROJECT NUMBER: CB205038

SITE: Perris Boulevard & Santiago Drive  
Moreno Valley

CLIENT: Perris at Pentecostal LLC  
Irvine, CA

# MOISTURE-DENSITY RELATIONSHIP

ASTM D698/D1557

LABORATORY TESTS ARE NOT VALID IF SEPARATED FROM ORIGINAL REPORT. COMPACTION - V1 CB205038 PROPOSED RESIDENT.GPJ TERRACON\_DATATEMPLATE.GDT 11/24/21

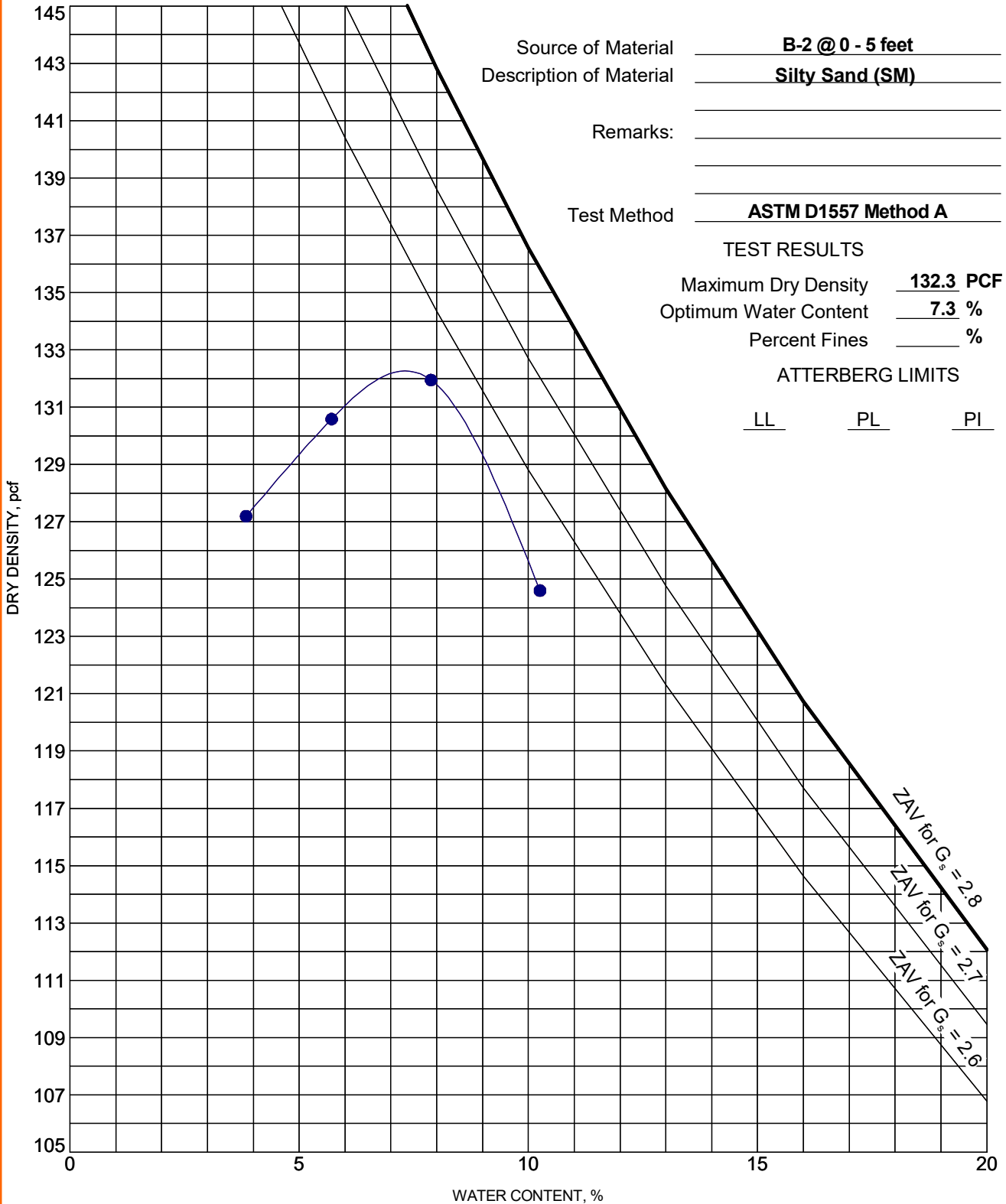

PROJECT: Proposed Residential Development

SITE: Perris Boulevard & Santiago Drive  
Moreno Valley



PROJECT NUMBER: CB205038

CLIENT: Perris at Pentecostal LLC  
Irvine, CA



# MOISTURE-DENSITY RELATIONSHIP

ASTM D698/D1557

LABORATORY TESTS ARE NOT VALID IF SEPARATED FROM ORIGINAL REPORT. COMPACTION - V1 CB205038 PROPOSED RESIDENTIAL.GPJ TERRACON.DATATEMPLATE.GDT 11/24/21

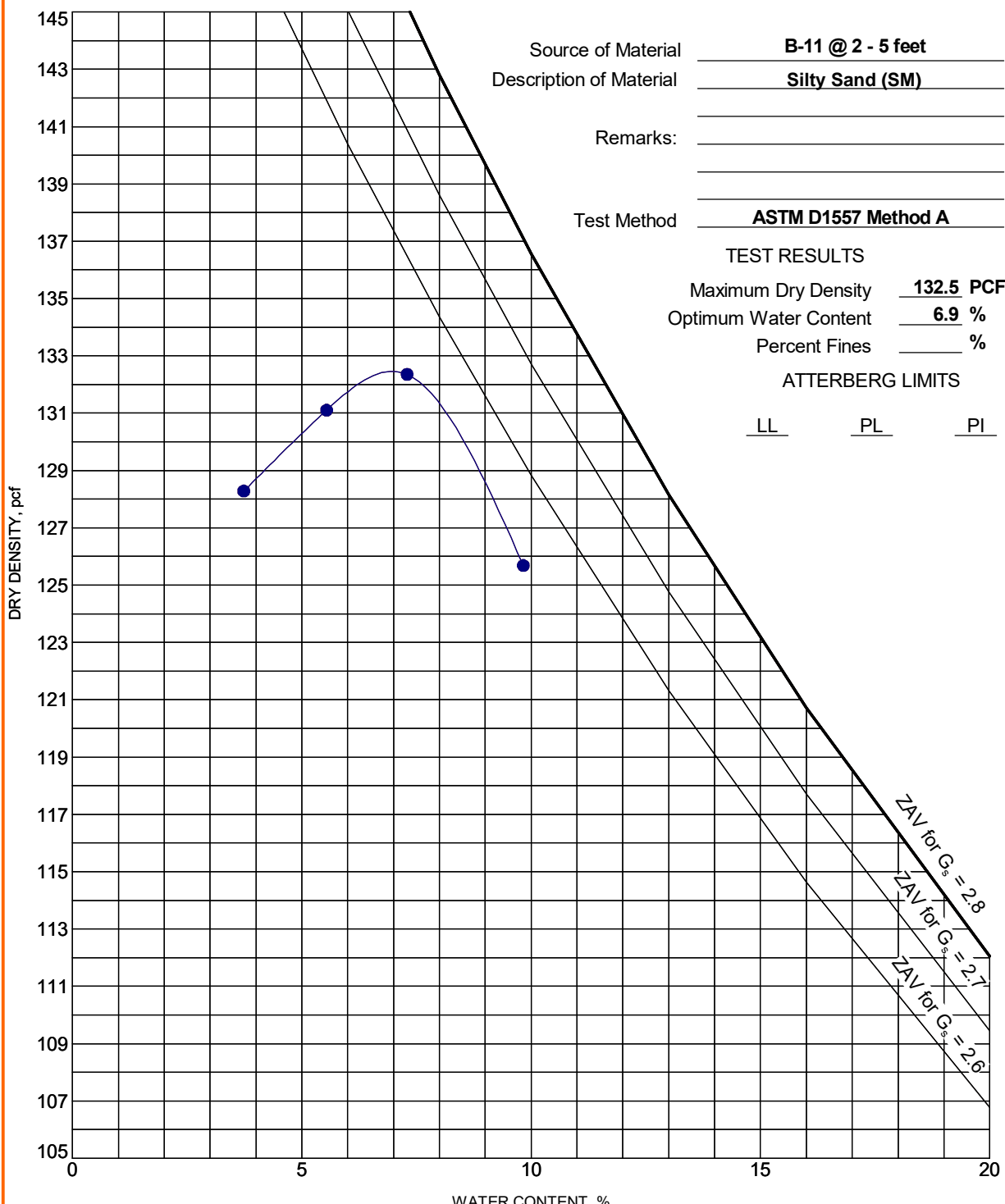

Source of Material B-11 @ 2 - 5 feet  
 Description of Material Silty Sand (SM)  
 Remarks: \_\_\_\_\_  
 Test Method ASTM D1557 Method A

**TEST RESULTS**  
 Maximum Dry Density 132.5 PCF  
 Optimum Water Content 6.9 %  
 Percent Fines \_\_\_\_\_ %  
**ATTERBERG LIMITS**  
LL PL PI

PROJECT: Proposed Residential Development  
 SITE: Perris Boulevard & Santiago Drive  
 Moreno Valley



PROJECT NUMBER: CB205038  
 CLIENT: Perris at Pentecostal LLC  
 Irvine, CA

Job No. CB205038  
 Date. 11/18/2021

**LABORATORY RECORD OF TESTS MADE ON  
 BASE, SUBBASE, AND BASEMENT SOILS**

**CLIENT:** Perris at Pentecostal  
**PROJECT** CCU  
**LOCATION:** Moreno Valley, CA  
**R-VALUE # :** 10A  
**T.I. :**

COMPACTOR AIR PRESSURE P.S.I.  
 INITIAL MOISTURE %  
 WATER ADDED, ML  
 WATER ADDED %  
 MOISTURE AT COMPACTION %  
 HEIGHT OF BRIQUETTE  
 WET WEIGHT OF BRIQUETTE  
 DENSITY LB. PER CU.FT.  
 STABILOMETER PH AT 1000 LBS.  
 2000 LBS.  
 DISPLACEMENT  
 R-VALUE  
 EXUDATION PRESSURE  
 THICK. INDICATED BY STAB.  
 EXPANSION PRESSURE  
 THICK. INDICATED BY E.P.

	<b>A</b>	<b>B</b>	<b>C</b>	<b>D</b>
COMPACTOR AIR PRESSURE P.S.I.	350	350	350	
INITIAL MOISTURE %	3.1	3.1	3.1	
WATER ADDED, ML	90	80	70	
WATER ADDED %	8.2	7.3	6.3	
MOISTURE AT COMPACTION %	11.3	10.4	9.4	
HEIGHT OF BRIQUETTE	2.47	2.49	2.51	
WET WEIGHT OF BRIQUETTE	1129	1136	1138	
DENSITY LB. PER CU.FT.	124.4	125.3	125.5	
STABILOMETER PH AT 1000 LBS.	37	29	22	
2000 LBS.	71	52	47	
DISPLACEMENT	5.50	5.20	4.80	
R-VALUE	36	50	56	
EXUDATION PRESSURE	180	300	580	
THICK. INDICATED BY STAB.	0.00	0.00	0.00	
EXPANSION PRESSURE	0	0	0	
THICK. INDICATED BY E.P.	0.00	0.00	0.00	

**EXUDATION CHART**

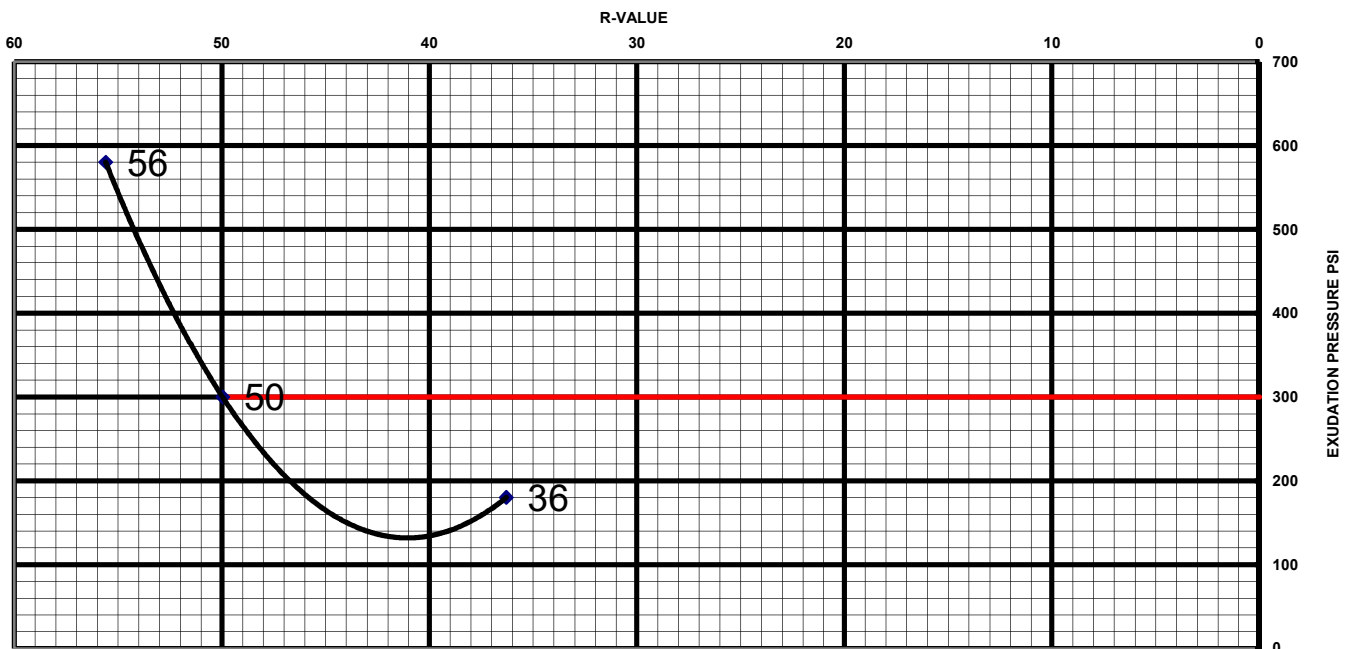

**R-Value: 50**

**Client**

Perris at Pentecostal LLC

**Project**

Proposed Residential Development  
Moreno Valley

**Sample Submitted By:** Terracon (CB)

**Date Received:** 11/1/2021

**Lab No.:** 21-0810

**Results of Corrosion Analysis**

<b>Sample Number</b>	8-A
<b>Sample Location</b>	B-8
<b>Sample Depth (ft.)</b>	0.0-5.0
pH Analysis, ASTM G 51	7.73
Water Soluble Sulfate (SO <sub>4</sub> ), ASTM C 1580 (mg/kg)	83
Chlorides, ASTM D 512, (mg/kg)	53
Total Salts, AWWA 2540, (mg/kg)	239
As-Received Resistivity, ASTM G 57, (ohm-cm)	34920
Saturated Minimum Resistivity, ASTM G 57, (ohm-cm)	4462



**Analyzed By:**

Nathan Campo  
Engineering Technician II

The tests were performed in general accordance with applicable ASTM and AWWA test methods. This report is exclusively for the use of the client indicated above and shall not be reproduced except in full without the written consent of our company. Test results transmitted herein are only applicable to the actual samples tested at the location(s) referenced and are not necessarily indicative of the properties of other apparently similar or identical materials.

**SUMMARY**  
**OF**  
**CONE PENETRATION TEST DATA**

Project:

**Residential Development  
Emma Lane & Iris Avenue  
Moreno Valley, CA  
October 20, 2021**

Prepared for:

**Mr. Sean Paroski  
Terracon Consultants, Inc.  
1355 E. Cooley Drive, Ste C  
Colton, CA 92324  
Office (909) 824-7311 / Fax (909) 301-6016**

Prepared by:



**KEHOE TESTING & ENGINEERING**

5415 Industrial Drive  
Huntington Beach, CA 92649-1518  
Office (714) 901-7270 / Fax (714) 901-7289  
[www.kehoetesting.com](http://www.kehoetesting.com)

# **TABLE OF CONTENTS**

- 1. INTRODUCTION**
- 2. SUMMARY OF FIELD WORK**
- 3. FIELD EQUIPMENT & PROCEDURES**
- 4. CONE PENETRATION TEST DATA & INTERPRETATION**

## **APPENDIX**

- CPT Plots
- CPT Classification/Soil Behavior Chart
- CPT Data Files (sent via email)

# SUMMARY OF CONE PENETRATION TEST DATA

## 1. INTRODUCTION

This report presents the results of a Cone Penetration Test (CPT) program carried out for the Residential Development project located at Emma Lane & Iris Avenue in Moreno Valley, California. The work was performed by Kehoe Testing & Engineering (KTE) on October 20, 2021. The scope of work was performed as directed by Terracon Consultants, Inc. personnel.

## 2. SUMMARY OF FIELD WORK

The fieldwork consisted of performing CPT soundings at seven locations to determine the soil lithology. A summary is provided in **TABLE 2.1**.

LOCATION	DEPTH OF CPT (ft)	COMMENTS/NOTES:
CPT-1	50	
CPT-2	50	
CPT-3	50	
CPT-4	100	
CPT-5	50	
CPT-6	50	
CPT-7	50	

**TABLE 2.1 - Summary of CPT Soundings**

## 3. FIELD EQUIPMENT & PROCEDURES

The CPT soundings were carried out by **KTE** using an integrated electronic cone system manufactured by Vertek. The CPT soundings were performed in accordance with ASTM standards (D5778). The cone penetrometers were pushed using a 30-ton CPT rig. The cone used during the program was a 15 cm<sup>2</sup> cone with a cone net area ratio of 0.83. The following parameters were recorded at approximately 2.5 cm depth intervals:

- Cone Resistance (qc)
- Sleeve Friction (fs)
- Dynamic Pore Pressure (u)
- Inclination
- Penetration Speed

The above parameters were recorded and viewed in real time using a laptop computer. Data is stored at the KTE office for up to 2 years for future analysis and reference. A complete set of baseline readings was taken prior to each sounding to determine temperature shifts and any zero load offsets. Monitoring base line readings ensures that the cone electronics are operating properly.

#### **4. CONE PENETRATION TEST DATA & INTERPRETATION**

The Cone Penetration Test data is presented in graphical form in the attached Appendix. These plots were generated using the CPeT-IT program. Penetration depths are referenced to ground surface. The soil behavior type on the CPT plots is derived from the attached CPT SBT plot (Robertson, "Interpretation of Cone Penetration Test...", 2009) and presents major soil lithologic changes. The stratigraphic interpretation is based on relationships between cone resistance ( $q_c$ ), sleeve friction ( $f_s$ ), and penetration pore pressure ( $u$ ). The friction ratio ( $R_f$ ), which is sleeve friction divided by cone resistance, is a calculated parameter that is used along with cone resistance to infer soil behavior type. Generally, cohesive soils (clays) have high friction ratios, low cone resistance and generate excess pore water pressures. Cohesionless soils (sands) have lower friction ratios, high cone bearing and generate little (or negative) excess pore water pressures.

The CPT data files have also been provided. These files can be imported in CPeT-IT (software by GeoLogismiki) and other programs to calculate various geotechnical parameters.

It should be noted that it is not always possible to clearly identify a soil type based on  $q_c$ ,  $f_s$  and  $u$ . In these situations, experience, judgement and an assessment of the pore pressure data should be used to infer the soil behavior type.

If you have any questions regarding this information, please do not hesitate to call our office at (714) 901-7270.

Sincerely,

#### **KEHOE TESTING & ENGINEERING**



Steven P. Kehoe  
President



# APPENDIX

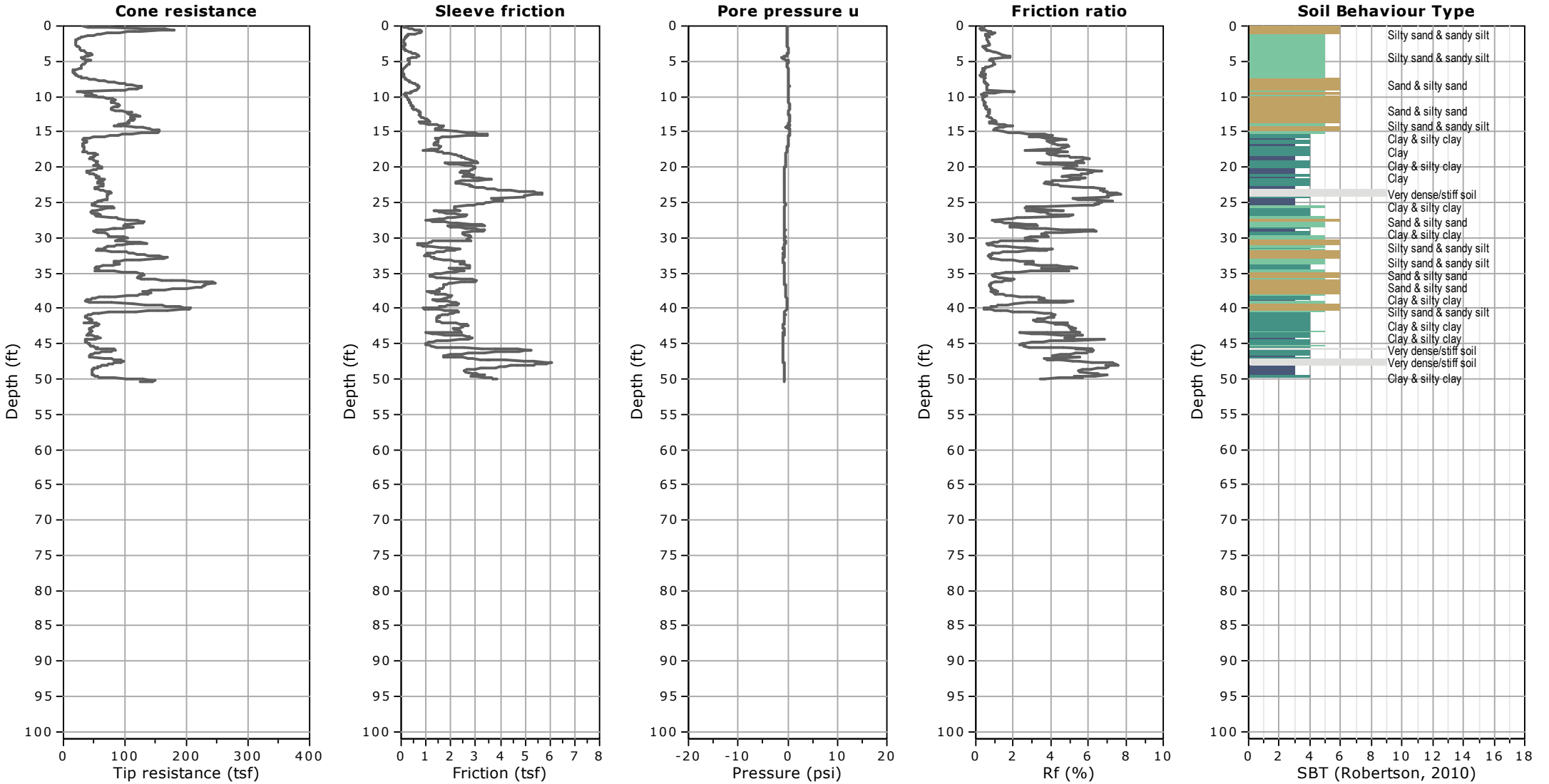

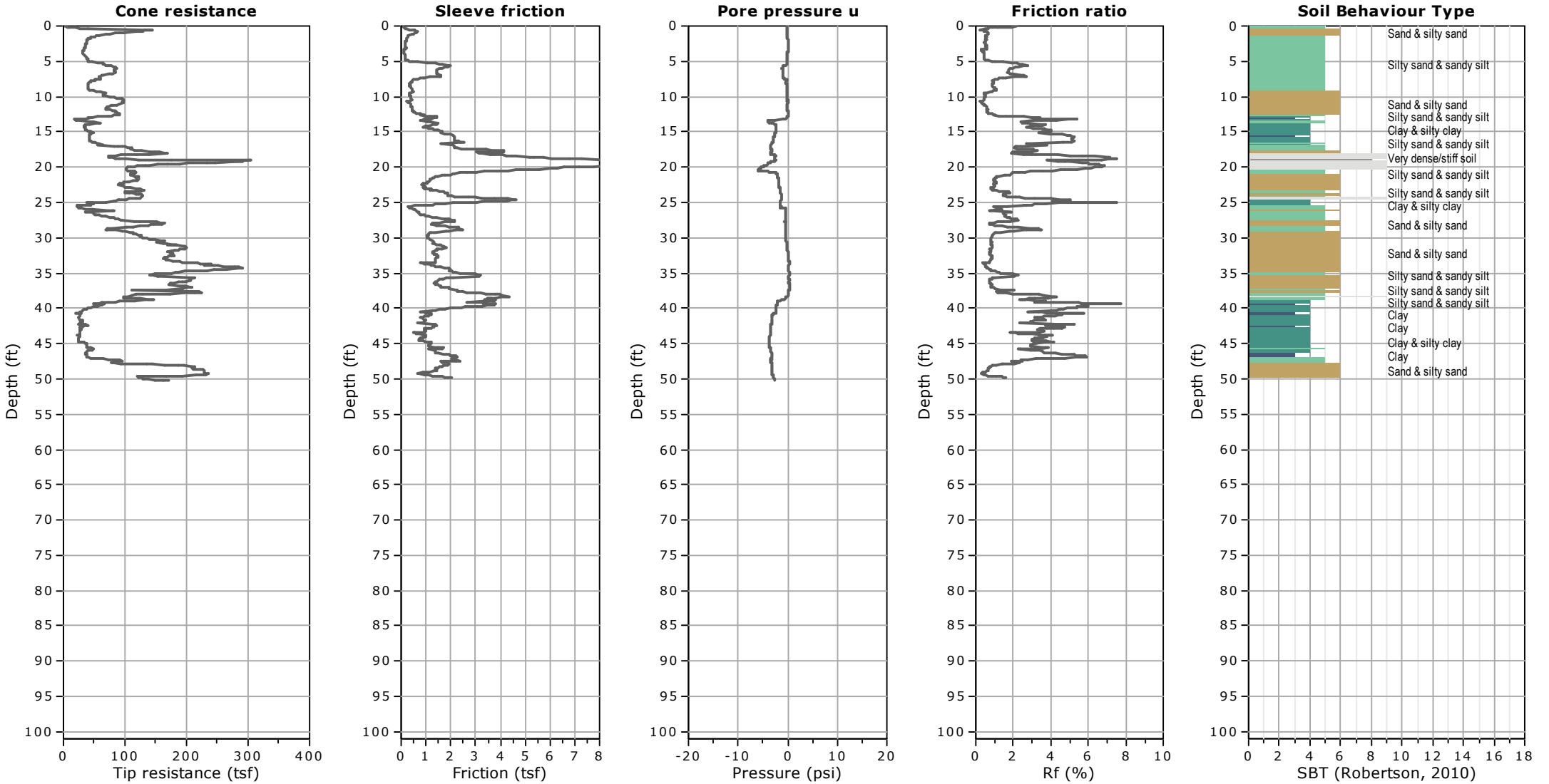

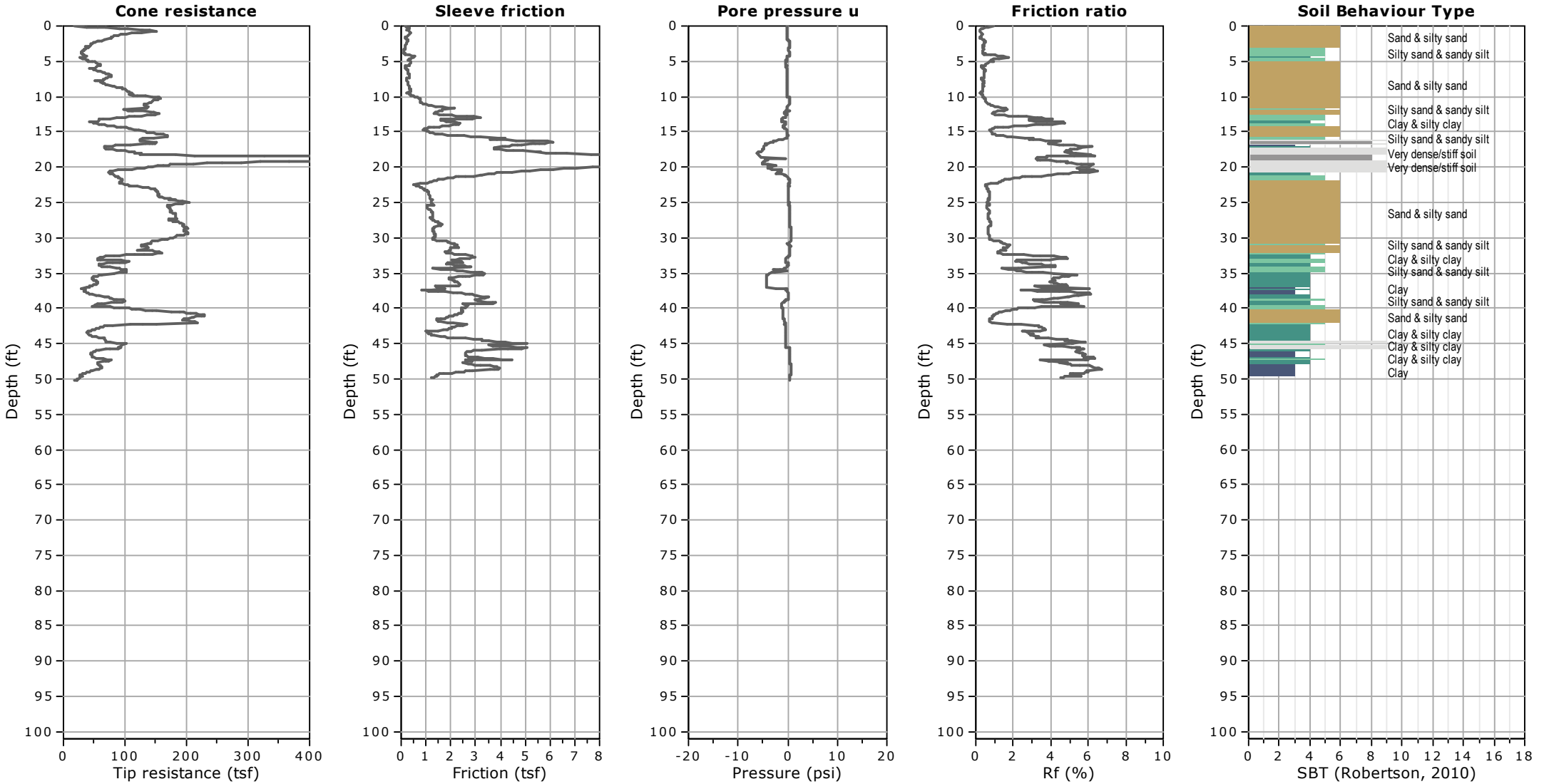

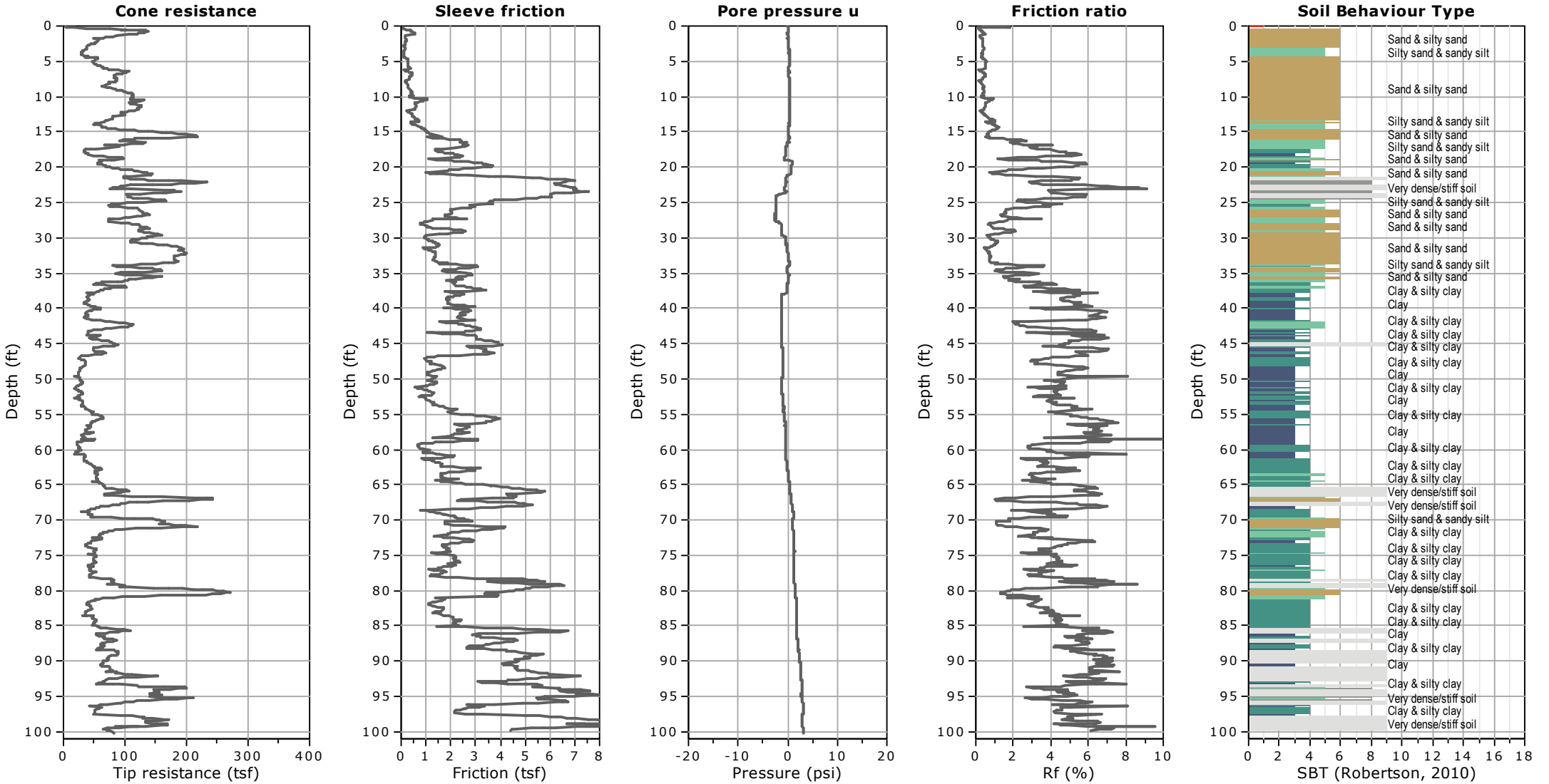

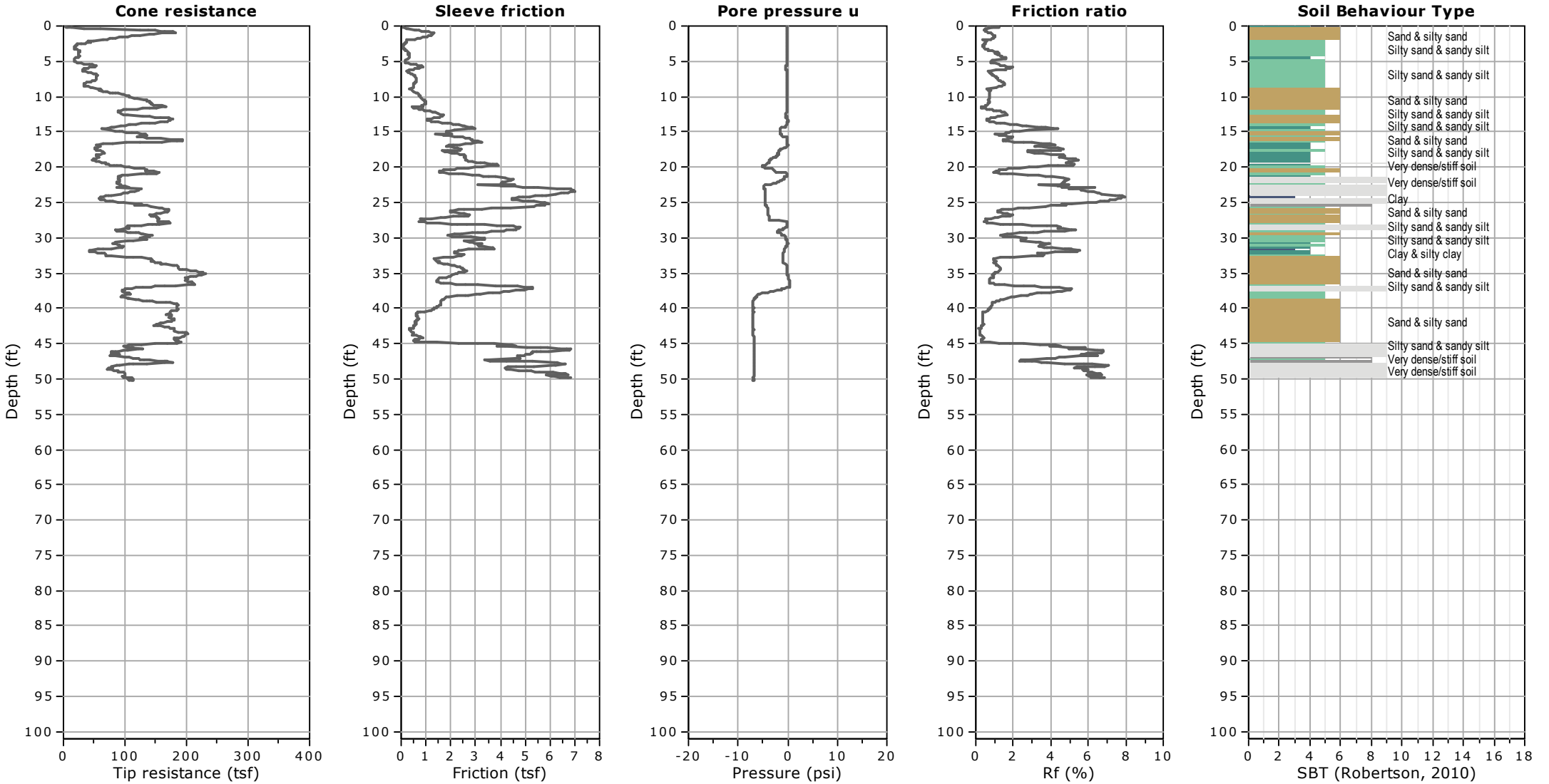

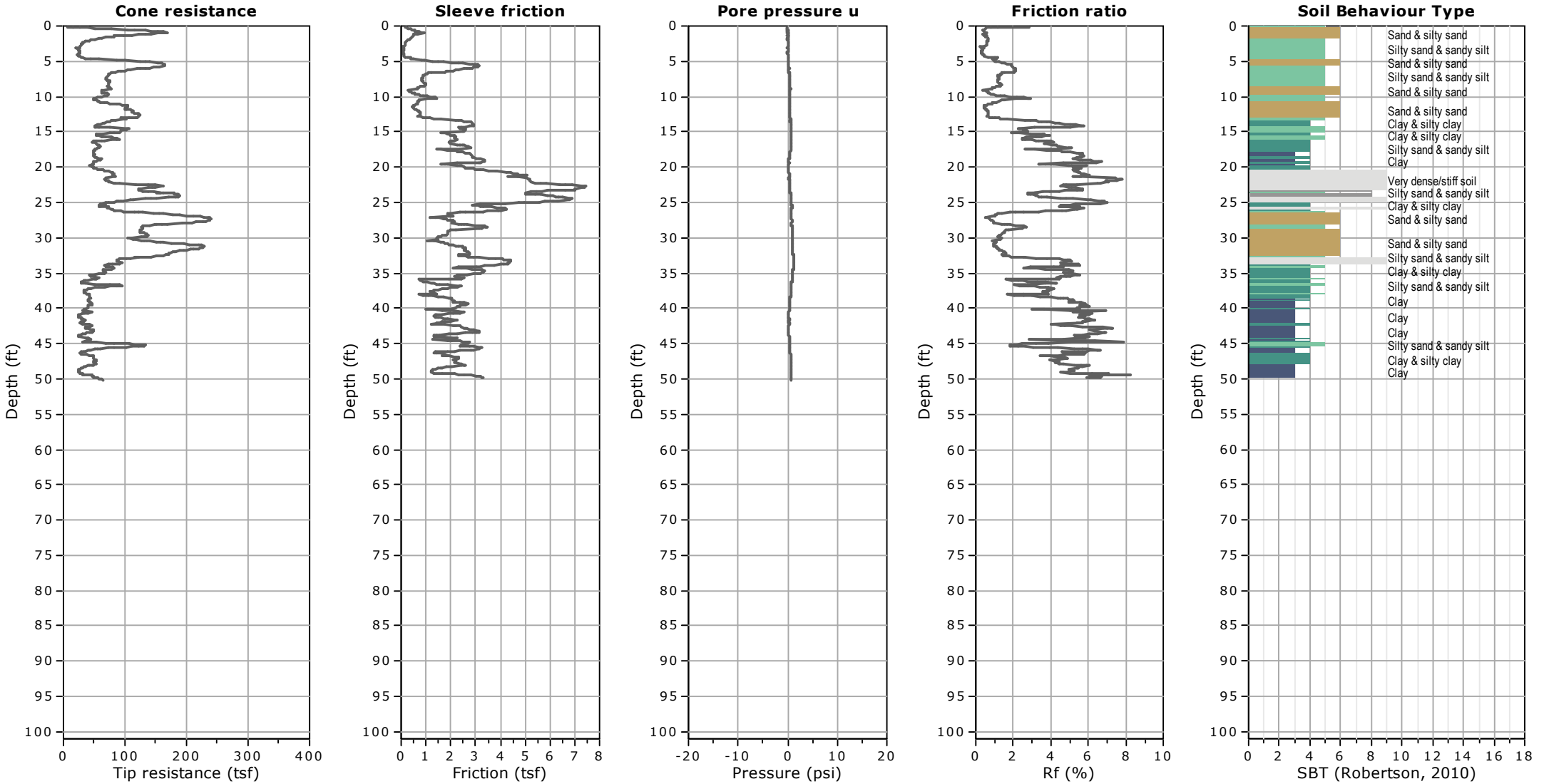



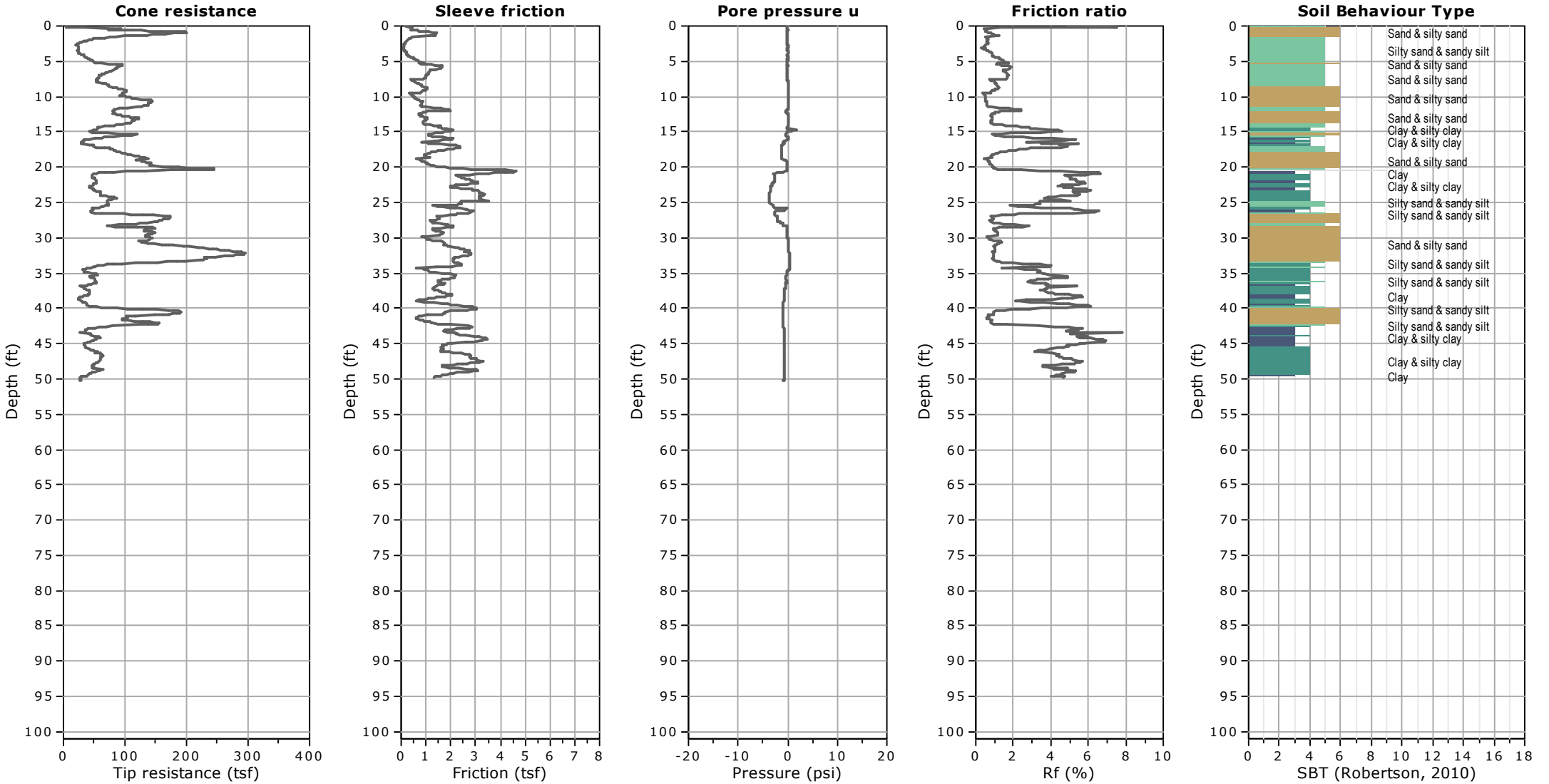



Kehoe Testing & Engineering

714-901-7270

steve@kehoetesting.com

www.kehoetesting.com

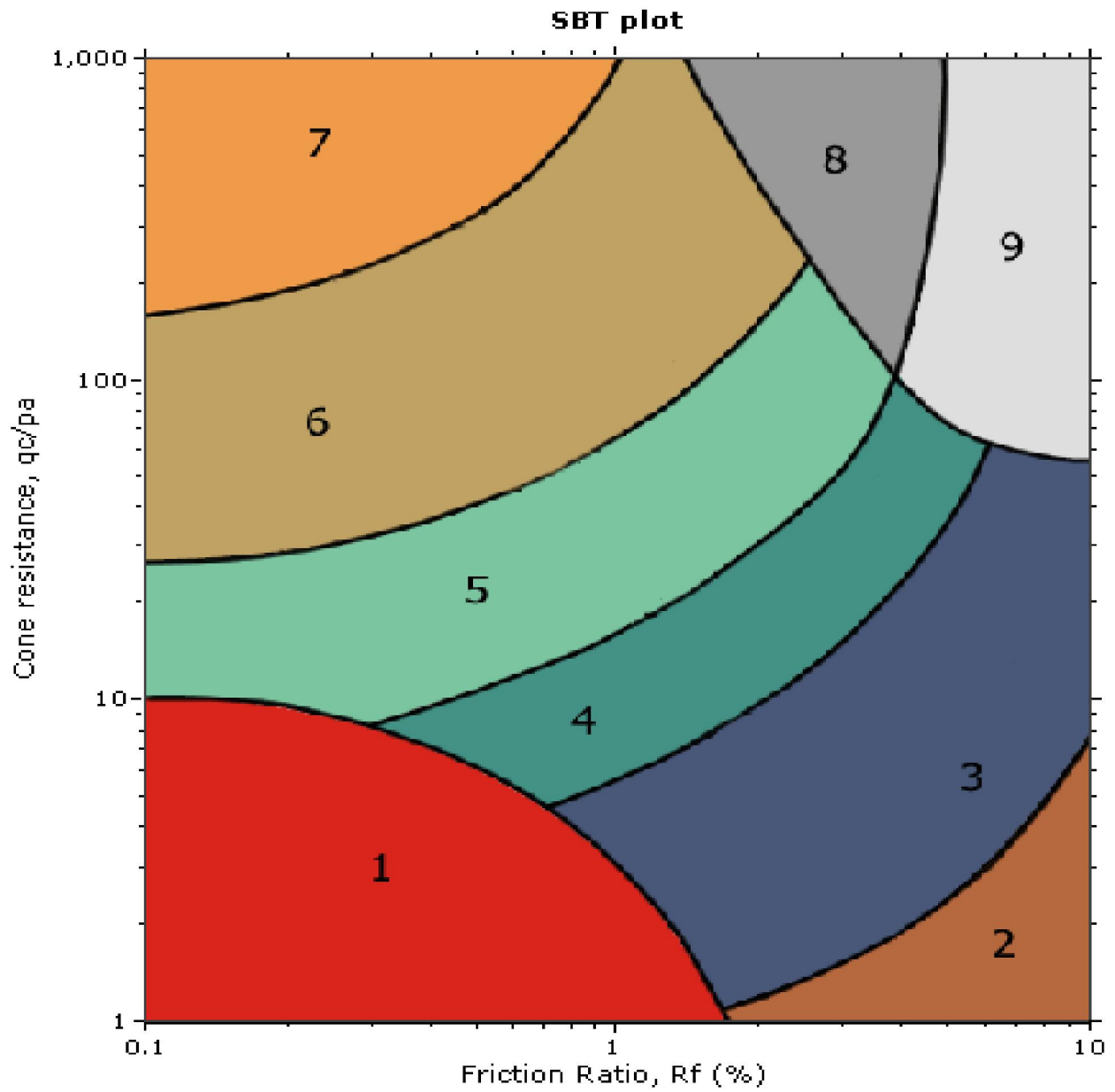

**SBT legend**

- |                           |                              |                                   |
|---------------------------|------------------------------|-----------------------------------|
| 1. Sensitive fine grained | 4. Clayey silt to silty clay | 7. Gravely sand to sand           |
| 2. Organic material       | 5. Silty sand to sandy silt  | 8. Very stiff sand to clayey sand |
| 3. Clay to silty clay     | 6. Clean sand to silty sand  | 9. Very stiff fine grained        |

# LIQUEFACTION ANALYSIS

## Proposed Residential Development

Hole No.=CPT-1 Water Depth=20 ft

Magnitude=7.04  
Acceleration=0.661g

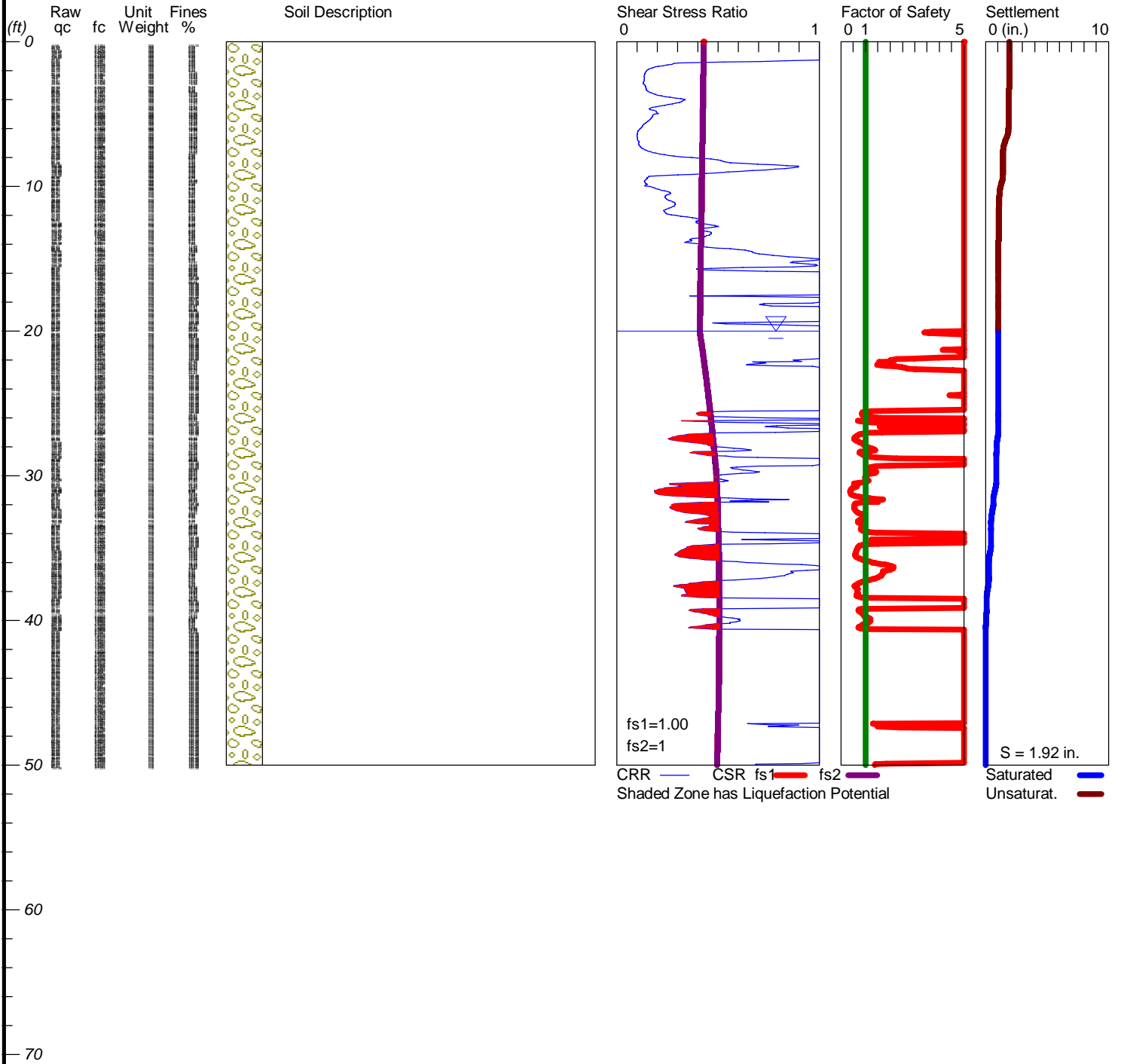

LiquefyPro CivilTech Software USA www.civiltech.com

# LIQUEFACTION ANALYSIS

## Proposed Residential Development

Hole No.=CPT-2 Water Depth=20 ft

Magnitude=7.04  
Acceleration=0.661g

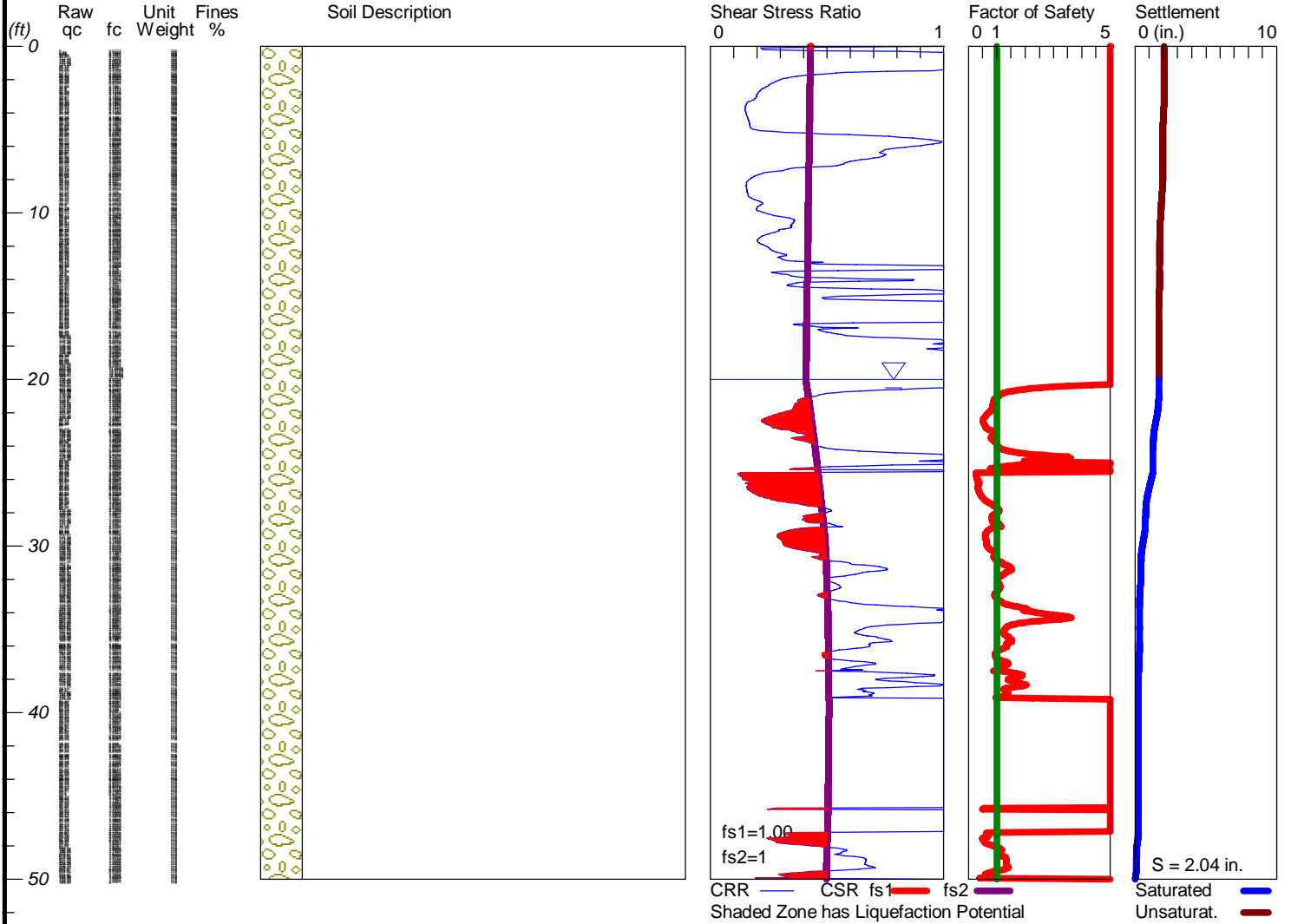

# LIQUEFACTION ANALYSIS

## Proposed Residential Development

Hole No.=CPT-3 Water Depth=20 ft

Magnitude=7.04  
Acceleration=0.661g

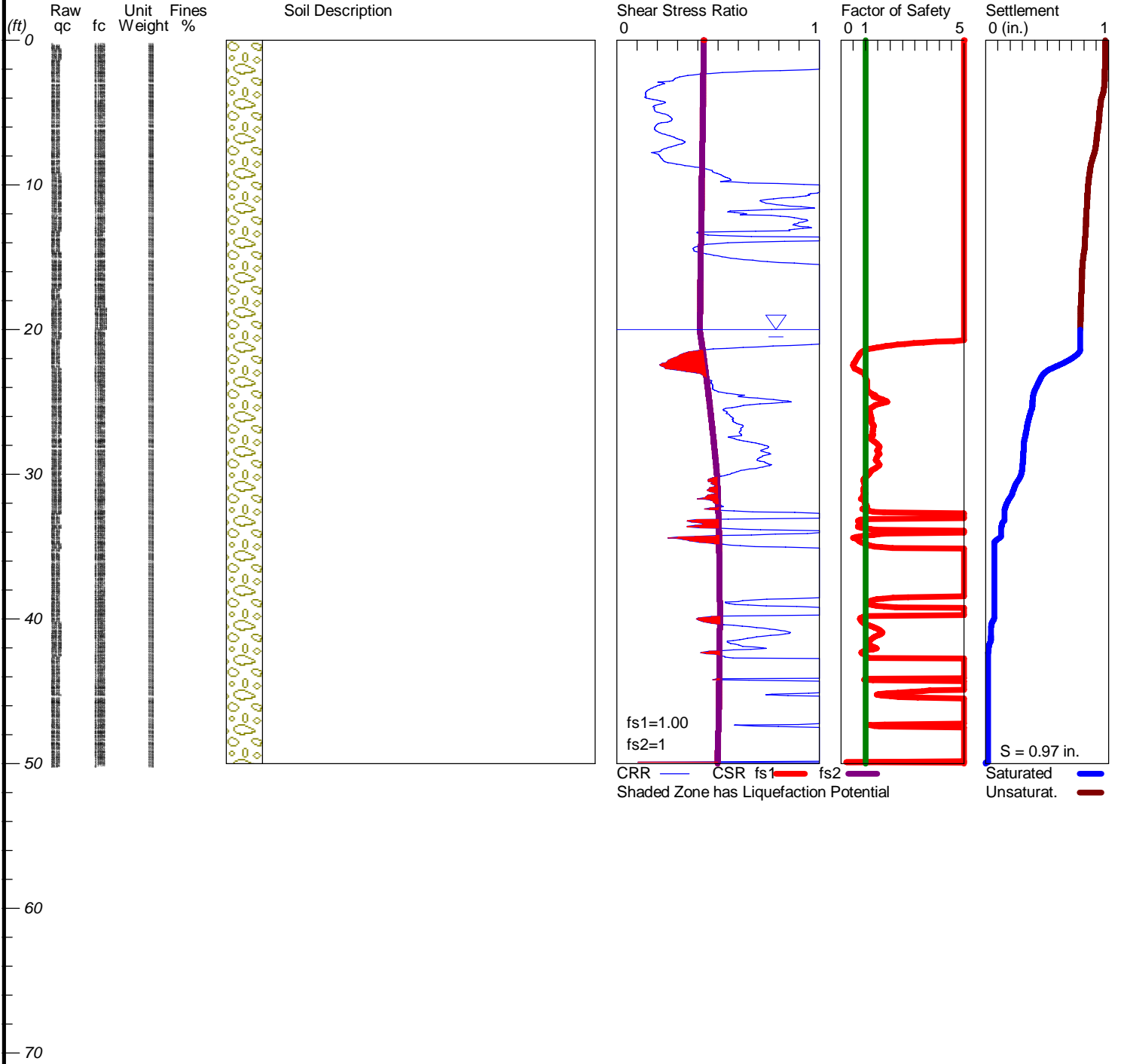

LiquefyPro CivilTech Software USA www.civiltech.com

# LIQUEFACTION ANALYSIS

## Proposed Residential Development

Hole No.=CPT-4 Water Depth=20 ft

Magnitude=7.04  
Acceleration=0.661g

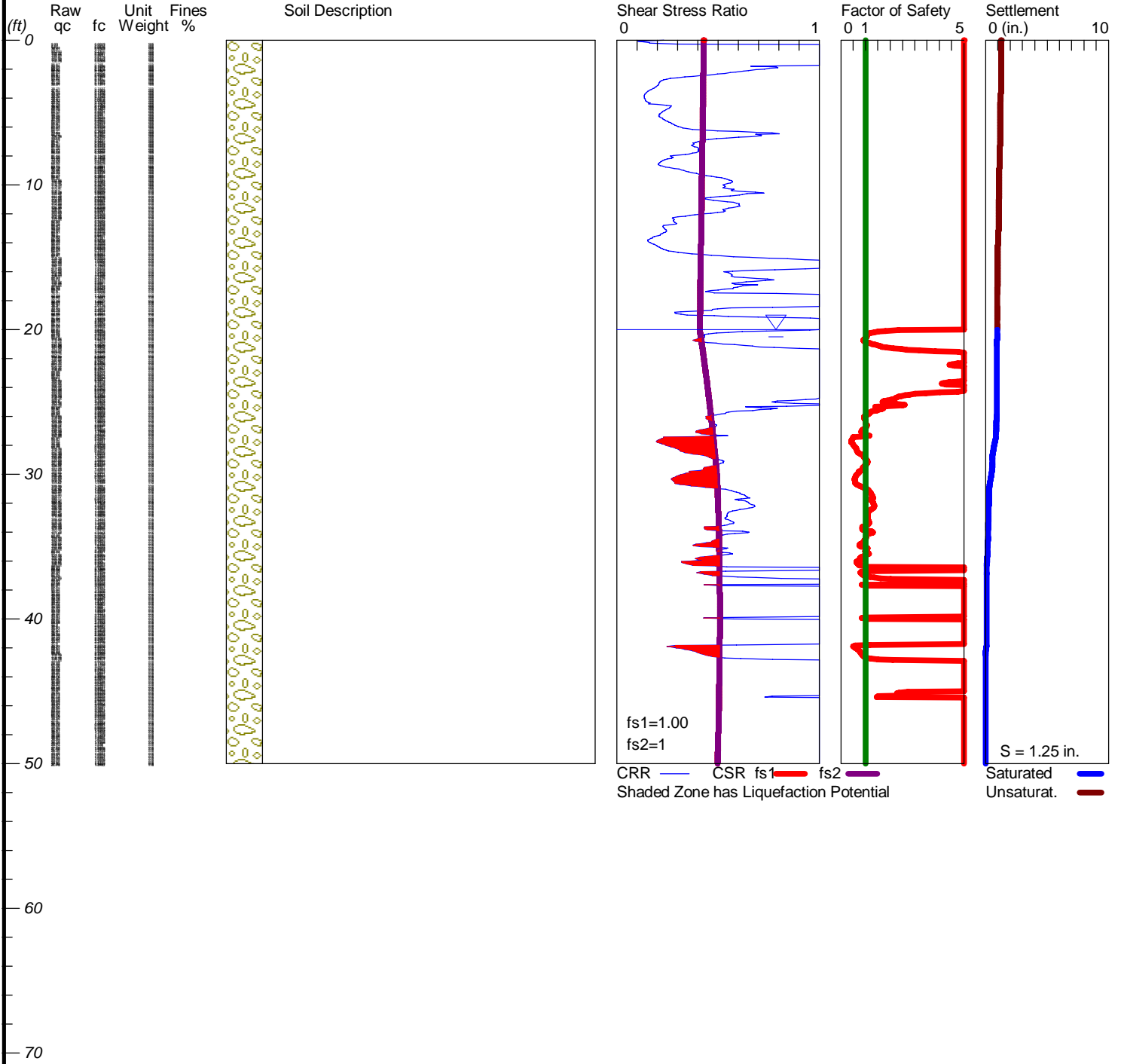

LiquefyPro CivilTech Software USA www.civiltech.com

# LIQUEFACTION ANALYSIS

## Proposed Residential Development

Hole No.=C-5 Water Depth=20 ft

Magnitude=7.04  
Acceleration=0.661g

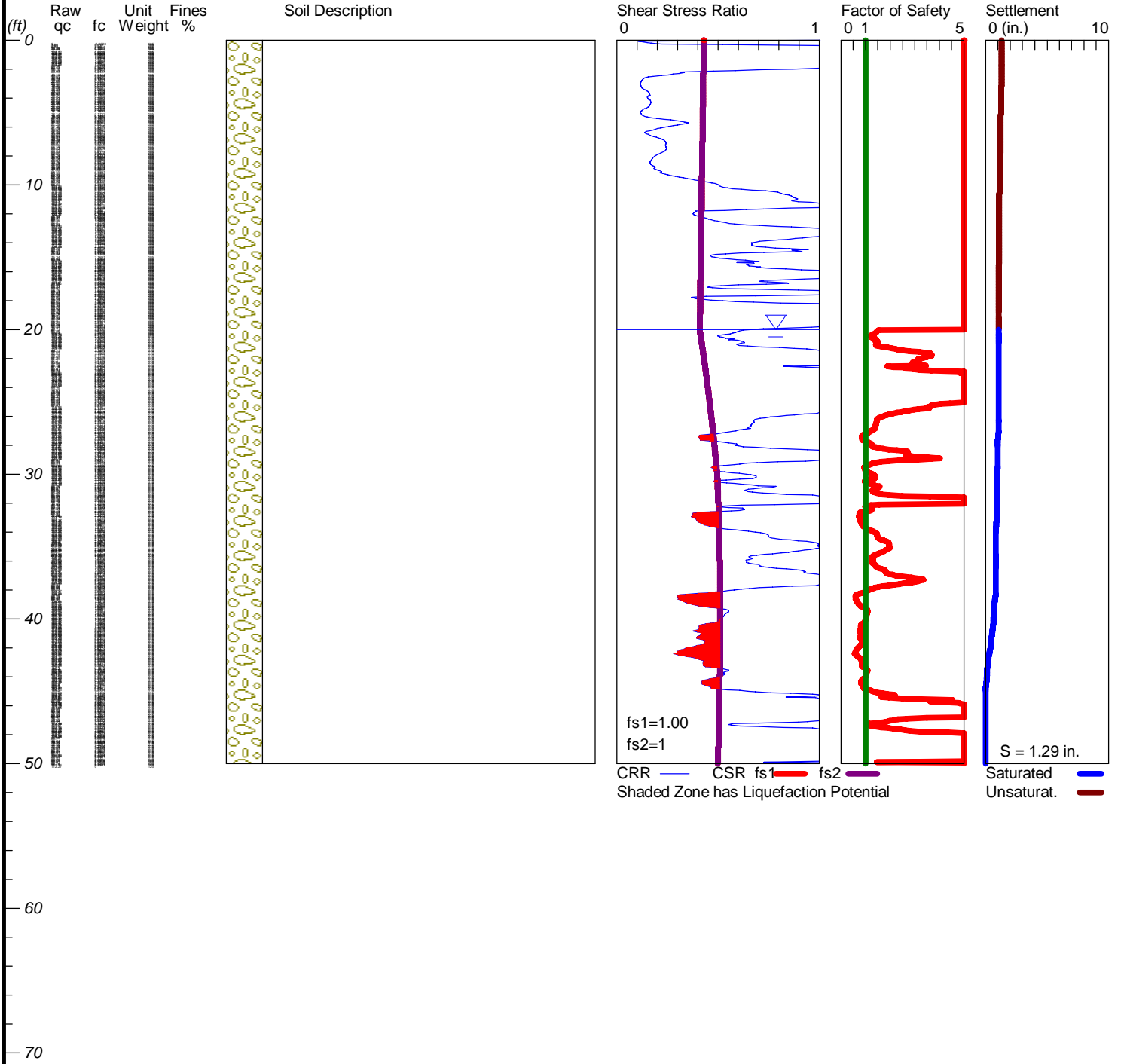

LiquefyPro CivilTech Software USA www.civiltech.com



# LIQUEFACTION ANALYSIS

## Proposed Residential Development

Hole No.=CPT-6 Water Depth=20 ft

Magnitude=7.04  
Acceleration=0.661g

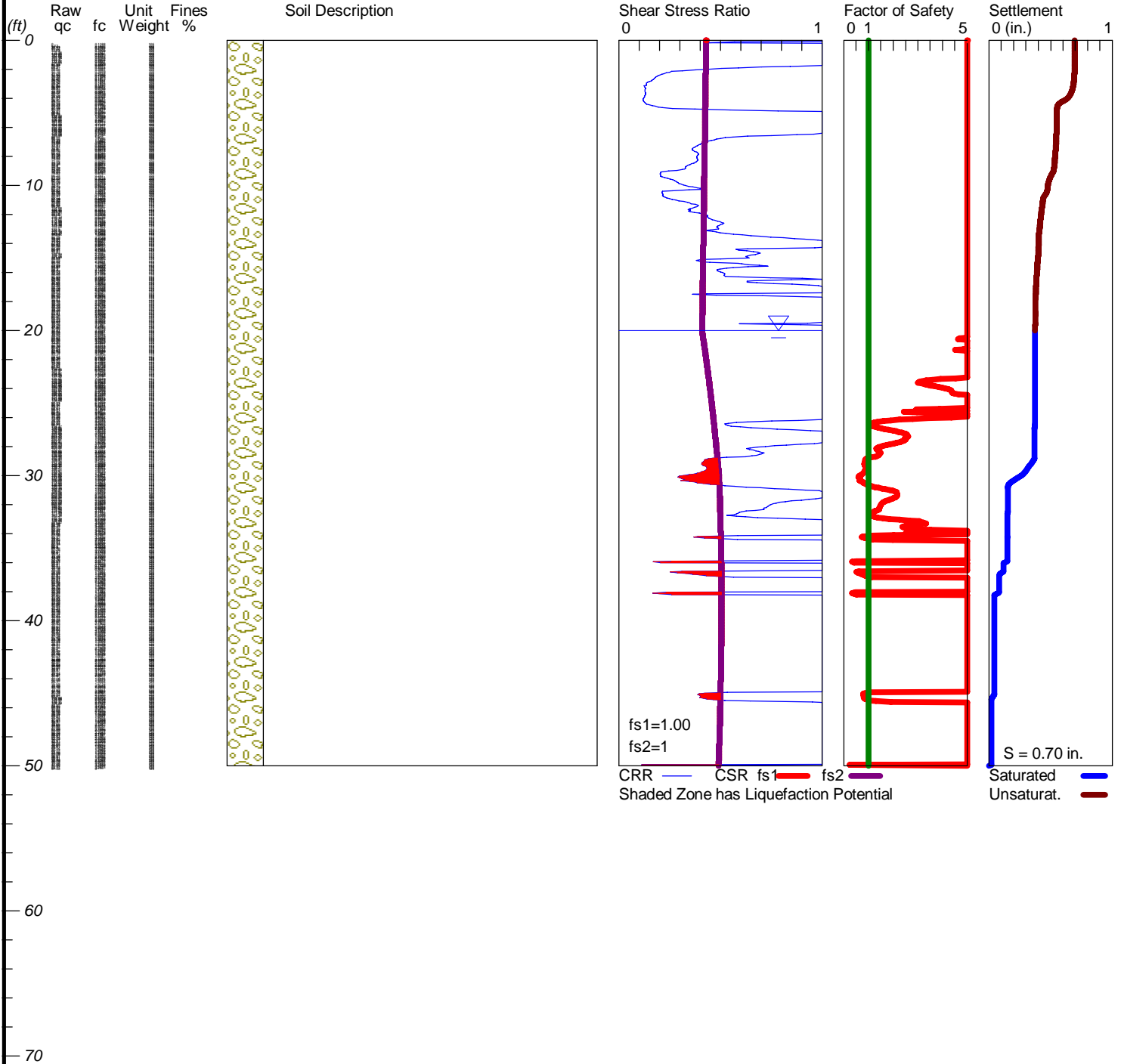

LiquefyPro CivilTech Software USA www.civiltech.com

# LIQUEFACTION ANALYSIS

## Proposed Residential Development

Hole No.=CPT-7 Water Depth=20 ft

Magnitude=7.04  
Acceleration=0.661g

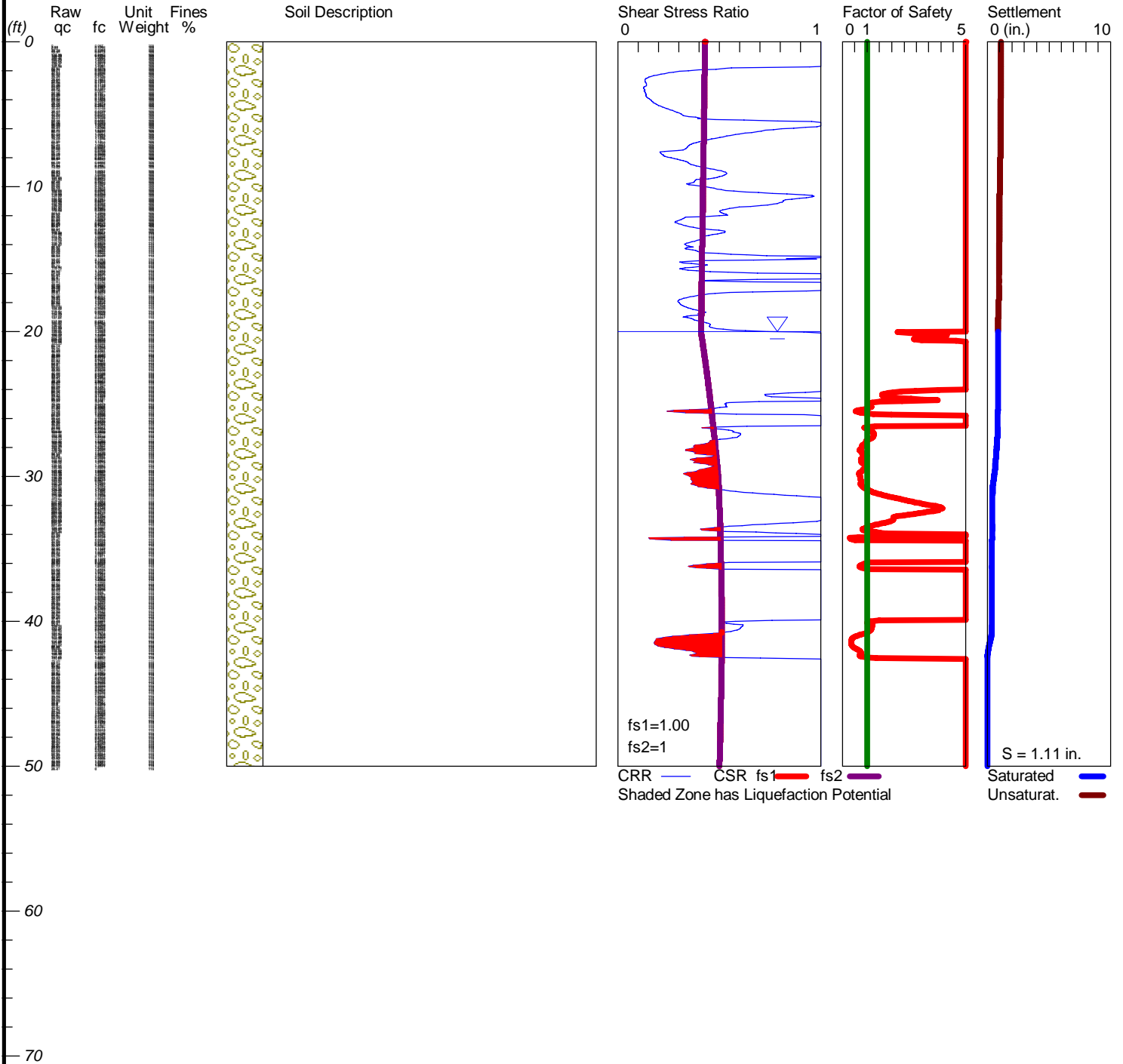

LiquefyPro CivilTech Software USA www.civilttech.com

## **SUPPORTING INFORMATION**













### **Contents:**

General Notes

Unified Soil Classification System

# GENERAL NOTES

## DESCRIPTION OF SYMBOLS AND ABBREVIATIONS

<b>SAMPLING</b>	 Auger	 Shelby Tube	 Split Spoon	<b>WATER LEVEL</b>	 Water Initially Encountered	<b>FIELD TESTS</b>	(HP) Hand Penetrometer
	 Rock Core	 Macro Core	 Modified California Ring Sampler		 Water Level After a Specified Period of Time		(T) Torvane
	 Grab Sample	 No Recovery	 Modified Dames & Moore Ring Sampler		 Water Level After a Specified Period of Time		(b/f) Standard Penetration Test (blows per foot)
					Water levels indicated on the soil boring logs are the levels measured in the borehole at the times indicated. Groundwater level variations will occur over time. In low permeability soils, accurate determination of groundwater levels is not possible with short term water level observations.		(N) N value
							(PID) Photo-Ionization Detector
							(OVA) Organic Vapor Analyzer
							(WOH) Weight of Hammer

## DESCRIPTIVE SOIL CLASSIFICATION

Soil classification is based on the Unified Soil Classification System. Coarse Grained Soils have more than 50% of their dry weight retained on a #200 sieve; their principal descriptors are: boulders, cobbles, gravel or sand. Fine Grained Soils have less than 50% of their dry weight retained on a #200 sieve; they are principally described as clays if they are plastic, and silts if they are slightly plastic or non-plastic. Major constituents may be added as modifiers and minor constituents may be added according to the relative proportions based on grain size. In addition to gradation, coarse-grained soils are defined on the basis of their in-place relative density and fine-grained soils on the basis of their consistency.

## LOCATION AND ELEVATION NOTES

Unless otherwise noted, Latitude and Longitude are approximately determined using a hand-held GPS device. The accuracy of such devices is variable. Surface elevation data annotated with +/- indicates that no actual topographical survey was conducted to confirm the surface elevation. Instead, the surface elevation was approximately determined from topographic maps of the area.

<b>STRENGTH TERMS</b>	<b>RELATIVE DENSITY OF COARSE-GRAINED SOILS</b> (More than 50% retained on No. 200 sieve.) Density determined by Standard Penetration Resistance Includes gravels, sands and silts.			<b>CONSISTENCY OF FINE-GRAINED SOILS</b> (50% or more passing the No. 200 sieve.) Consistency determined by laboratory shear strength testing, field visual-manual procedures or standard penetration resistance			
	Descriptive Term (Density)	Standard Penetration or N-Value Blows/Ft.	Ring Sampler Blows/Ft.	Descriptive Term (Consistency)	Unconfined Compressive Strength, Qu, psf	Standard Penetration or N-Value Blows/Ft.	Ring Sampler Blows/Ft.
Very Loose	0 - 3	0 - 6	Very Soft	less than 500	0 - 1	< 3	
Loose	4 - 9	7 - 18	Soft	500 to 1,000	2 - 4	3 - 4	
Medium Dense	10 - 29	19 - 58	Medium-Stiff	1,000 to 2,000	4 - 8	5 - 9	
Dense	30 - 50	59 - 98	Stiff	2,000 to 4,000	8 - 15	10 - 18	
Very Dense	> 50	≥ 99	Very Stiff	4,000 to 8,000	15 - 30	19 - 42	
			Hard	> 8,000	> 30	> 42	

## RELATIVE PROPORTIONS OF SAND AND GRAVEL

Descriptive Term(s) of other constituents	Percent of Dry Weight
Trace	< 15
With	15 - 29
Modifier	> 30

## GRAIN SIZE TERMINOLOGY

Major Component of Sample	Particle Size
Boulders	Over 12 in. (300 mm)
Cobbles	12 in. to 3 in. (300mm to 75mm)
Gravel	3 in. to #4 sieve (75mm to 4.75 mm)
Sand	#4 to #200 sieve (4.75mm to 0.075mm)
Silt or Clay	Passing #200 sieve (0.075mm)

## RELATIVE PROPORTIONS OF FINES

Descriptive Term(s) of other constituents	Percent of Dry Weight
Trace	< 5
With	5 - 12
Modifier	> 12

## PLASTICITY DESCRIPTION

Term	Plasticity Index
Non-plastic	0
Low	1 - 10
Medium	11 - 30
High	> 30

Criteria for Assigning Group Symbols and Group Names Using Laboratory Tests <sup>A</sup>				Soil Classification			
				Group Symbol	Group Name <sup>B</sup>		
<b>Coarse-Grained Soils:</b> More than 50% retained on No. 200 sieve	<b>Gravels:</b> More than 50% of coarse fraction retained on No. 4 sieve	<b>Clean Gravels:</b> Less than 5% fines <sup>C</sup>	$Cu \geq 4$ and $1 \leq Cc \leq 3$ <sup>E</sup>	GW	Well-graded gravel <sup>F</sup>		
			$Cu < 4$ and/or $[Cc < 1$ or $Cc > 3.0]$ <sup>E</sup>	GP	Poorly graded gravel <sup>F</sup>		
		<b>Gravels with Fines:</b> More than 12% fines <sup>C</sup>	Fines classify as ML or MH	GM	Silty gravel <sup>F, G, H</sup>		
			Fines classify as CL or CH	GC	Clayey gravel <sup>F, G, H</sup>		
	<b>Sands:</b> 50% or more of coarse fraction passes No. 4 sieve	<b>Clean Sands:</b> Less than 5% fines <sup>D</sup>	$Cu \geq 6$ and $1 \leq Cc \leq 3$ <sup>E</sup>	SW	Well-graded sand <sup>I</sup>		
			$Cu < 6$ and/or $[Cc < 1$ or $Cc > 3.0]$ <sup>E</sup>	SP	Poorly graded sand <sup>I</sup>		
		<b>Sands with Fines:</b> More than 12% fines <sup>D</sup>	Fines classify as ML or MH	SM	Silty sand <sup>G, H, I</sup>		
			Fines classify as CL or CH	SC	Clayey sand <sup>G, H, I</sup>		
		<b>Fine-Grained Soils:</b> 50% or more passes the No. 200 sieve	<b>Silts and Clays:</b> Liquid limit less than 50	<b>Inorganic:</b>	$PI > 7$ and plots on or above "A"	CL	Lean clay <sup>K, L, M</sup>
					$PI < 4$ or plots below "A" line <sup>J</sup>	ML	Silt <sup>K, L, M</sup>
<b>Organic:</b>	Liquid limit - oven dried			$< 0.75$	OL	Organic clay <sup>K, L, M, N</sup>	
	Liquid limit - not dried					Organic silt <sup>K, L, M, O</sup>	
<b>Silts and Clays:</b> Liquid limit 50 or more	<b>Inorganic:</b>		$PI$ plots on or above "A" line	CH	Fat clay <sup>K, L, M</sup>		
			$PI$ plots below "A" line	MH	Elastic Silt <sup>K, L, M</sup>		
	<b>Organic:</b>		Liquid limit - oven dried	$< 0.75$	OH	Organic clay <sup>K, L, M, P</sup>	
			Liquid limit - not dried			Organic silt <sup>K, L, M, Q</sup>	
	<b>Highly organic soils:</b>		Primarily organic matter, dark in color, and organic odor		PT	Peat	

<sup>A</sup> Based on the material passing the 3-inch (75-mm) sieve.

<sup>B</sup> If field sample contained cobbles or boulders, or both, add "with cobbles or boulders, or both" to group name.

<sup>C</sup> Gravels with 5 to 12% fines require dual symbols: GW-GM well-graded gravel with silt, GW-GC well-graded gravel with clay, GP-GM poorly graded gravel with silt, GP-GC poorly graded gravel with clay.

<sup>D</sup> Sands with 5 to 12% fines require dual symbols: SW-SM well-graded sand with silt, SW-SC well-graded sand with clay, SP-SM poorly graded sand with silt, SP-SC poorly graded sand with clay.

<sup>E</sup>  $Cu = D_{60}/D_{10}$      $Cc = \frac{(D_{30})^2}{D_{10} \times D_{60}}$

<sup>F</sup> If soil contains  $\geq 15\%$  sand, add "with sand" to group name.

<sup>G</sup> If fines classify as CL-ML, use dual symbol GC-GM, or SC-SM.

<sup>H</sup> If fines are organic, add "with organic fines" to group name.

<sup>I</sup> If soil contains  $\geq 15\%$  gravel, add "with gravel" to group name.

<sup>J</sup> If Atterberg limits plot in shaded area, soil is a CL-ML, silty clay.

<sup>K</sup> If soil contains 15 to 29% plus No. 200, add "with sand" or "with gravel," whichever is predominant.

<sup>L</sup> If soil contains  $\geq 30\%$  plus No. 200 predominantly sand, add "sandy" to group name.

<sup>M</sup> If soil contains  $\geq 30\%$  plus No. 200, predominantly gravel, add "gravelly" to group name.

<sup>N</sup>  $PI \geq 4$  and plots on or above "A" line.

<sup>O</sup>  $PI < 4$  or plots below "A" line.

<sup>P</sup>  $PI$  plots on or above "A" line.

<sup>Q</sup>  $PI$  plots below "A" line.

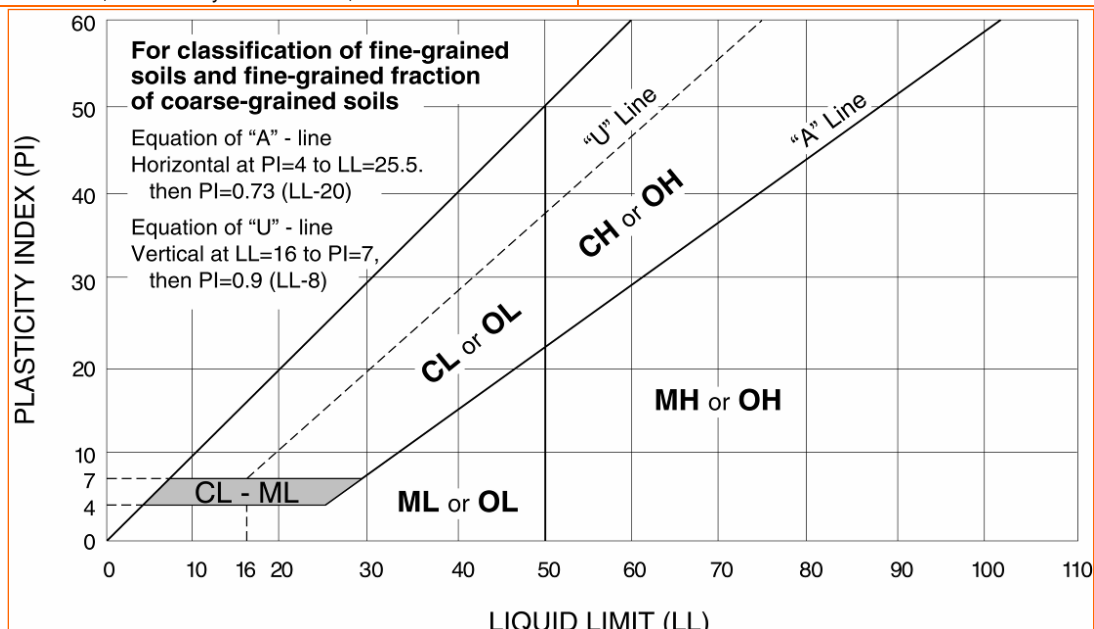

# Appendix 4: Historical Site Conditions

*Phase I Environmental Site Assessment or Other Information on Past Site Use*

# Appendix 5: LID Infeasibility

*LID Technical Infeasibility Analysis*



# Appendix 6: BMP Design Details

*BMP Sizing, Design Details and other Supporting Documentation*

Infiltration Basin - Design Procedure (Rev. 03-2012)		BMP ID	Legend:	Required Entries
Company Name: Pentacostal LLC				Calculated Cells
Designed by: BB			County/City Case No.:	Date: 8/17/2021
<b>Design Volume</b>				
a) Tributary area (BMP subarea)		$A_T =$	20.4	acres
b) Enter $V_{BMP}$ determined from Section 2.1 of this Handbook		$V_{BMP} =$	30,752	ft <sup>3</sup>
<b>Maximum Depth</b>				
a) Infiltration rate		$I =$	4.76	in/hr
b) Factor of Safety (See Table 1, Appendix A: "Infiltration Testing" from this BMP Handbook)		$FS =$	3	
c) Calculate $D_1$	$D_1 = \frac{I \text{ (in/hr)} \times 72 \text{ hrs}}{12 \text{ (in/ft)} \times FS}$	$D_1 =$	9.5	ft
d) Enter the depth of freeboard (at least 1 ft)			1	ft
e) Enter depth to historic high ground water (measured from <b>top</b> of basin)			40	ft
f) Enter depth to top of bedrock or impermeable layer (measured from <b>top</b> of basin)			20	ft
g) $D_2$ is the smaller of:				
Depth to groundwater - (10 ft + freeboard) and		$D_2 =$	14.0	ft
Depth to impermeable layer - (5 ft + freeboard)				
h) $D_{MAX}$ is the smaller value of $D_1$ and $D_2$ but shall not exceed 5 feet		$D_{MAX} =$	9.5	ft
<b>Basin Geometry</b>				
a) Basin side slopes (no steeper than 4:1)		$z =$	4	:1
b) Proposed basin depth (excluding freeboard)		$d_B =$	5	ft
c) Minimum bottom surface area of basin ( $A_S = V_{BMP}/d_B$ )		$A_S =$	6150	ft <sup>2</sup>
d) Proposed Design Surface Area		$A_D =$	10978	ft <sup>2</sup>
<b>Forebay</b>				
a) Forebay volume (minimum 0.5% $V_{BMP}$ )		Volume =	154	ft <sup>3</sup>
b) Forebay depth (height of berm/splashwall. 1 foot min.)		Depth =	1	ft
c) Forebay surface area (minimum)		Area =	154	ft <sup>2</sup>
d) Full height notch-type weir		Width (W) =	1.5	in
Notes: 2 forebays at 100 SF each for 200 total SF (exceeding 154 SF required)				

**Santa Ana Watershed - BMP Design Volume,  $V_{BMP}$**

(Rev. 10-2011)

Legend:

Required Entries

Calculated Cells

*(Note this worksheet shall **only** be used in conjunction with BMP designs from the **LID BMP Design Handbook**)*

Company Name Pentecostal LLC Date 8/17/2021  
 Designed by BB Case No                       
 Company Project Number/Name 20200259 Perris at Pentecostal

**BMP Identification**

BMP NAME / ID Infiltration Basin  
*Must match Name/ID used on BMP Design Calculation Sheet*

**Design Rainfall Depth**

85th Percentile, 24-hour Rainfall Depth,  $D_{85} =$  0.65 inches  
 from the Isohyetal Map in Handbook Appendix E

**Drainage Management Area Tabulation**

*Insert additional rows if needed to accommodate all DMAs draining to the BMP*

DMA Type/ID	DMA Area (square feet)	Post-Project Surface Type	Effective Imperivous Fraction, $I_f$	DMA Runoff Factor	DMA Areas x Runoff Factor	Design Storm Depth (in)	Design Capture Volume, $V_{BMP}$ (cubic feet)	Proposed Volume on Plans (cubic feet)
DMA-1 Residential	485995	Mixed Surface Types	0.82	0.62	302911.8			
DMA-2 Open Space	120729	Ornamental Landscaping	0.1	0.11	13335.5			
DMA-3 Street	281924	Concrete or Asphalt	1	0.89	251476.2			
<b>888648</b>		<b>Total</b>			<b>567723.5</b>	<b>0.65</b>	<b>30751.7</b>	<b>54890</b>

Notes:

Infiltration Trench - Design Procedure		BMP ID	Legend:	Required Entries
		DMA-4		Calculated Cells
Company Name:	GreenbergFarrow		Date:	8/18/2020
Designed by:	BB		County/City Case No.:	
<b>Design Volume</b>				
Enter the area tributary to this feature, Max = 10 acres			$A_t =$	0.26 acres
Enter $V_{BMP}$ determined from Section 2.1 of this Handbook			$V_{BMP} =$	429 ft <sup>3</sup>
<b>Calculate Maximum Depth of the Reservoir Layer</b>				
Enter Infiltration rate			$I =$	2.41 in/hr
Enter Factor of Safety, FS (unitless)			$FS =$	10
<i>Obtain from Table 1, Appendix A: "Infiltration Testing" of this BMP Handbook</i>				
Calculate $D_1$ .			$D_1 =$	3.62 ft
$D_1 = \frac{I \text{ (in/hr)} \times 72 \text{ hrs}}{12 \text{ (in/ft)} \times (n/100) \times FS}$			$n =$	40 %
Enter depth to historic high groundwater mark (measured from finished grade)				40 ft
Enter depth to top of bedrock or impermeable layer (measured from finished grade)				20 ft
$D_2$ is the smaller of:				
Depth to groundwater - 11 ft; & Depth to impermeable layer - 6 ft			$D_2 =$	14.0 ft
$D_{MAX}$ is the smaller value of $D_1$ and $D_2$ , must be less than or equal to 8 feet.			$D_{MAX} =$	3.6 ft
<b>Trench Sizing</b>				
Enter proposed reservoir layer depth $D_R$ , must be $\leq D_{MAX}$			$D_R =$	3.60 ft
Calculate the design depth of water, $d_w$				
Design $d_w = (D_R) \times (n/100)$			Design $d_w =$	1.44 ft
Minimum Surface Area, $A_S$			$A_S =$	298 ft <sup>2</sup>
			$A_S = \frac{V_{BMP}}{d_w}$	
Proposed Design Surface Area			$A_D =$	300 ft <sup>2</sup>
Minimum Width = $D_R + 1$ foot pea gravel				4.60 ft
Sediment Control Provided? (Use pulldown)		Yes		
Geotechnical report attached? (Use pulldown)		Yes		

If the trench has been designed correctly, there should be no error messages on the spreadsheet.

**Santa Ana Watershed - BMP Design Volume,  $V_{BMP}$**

(Rev. 10-2011)

Legend:

Required Entries

Calculated Cells

*(Note this worksheet shall **only** be used in conjunction with BMP designs from the **LID BMP Design Handbook**)*

Company Name Pentecostal LLC

Date 8/18/2020

Designed by BB

Case No

Company Project Number/Name 20200259 Perris at Pentecostal

**BMP Identification**

BMP NAME / ID DMA-4 Infiltration Trench

*Must match Name/ID used on BMP Design Calculation Sheet*

**Design Rainfall Depth**

85th Percentile, 24-hour Rainfall Depth,  
from the Isohyetal Map in Handbook Appendix E

$D_{85}$  = 0.65 inches

**Drainage Management Area Tabulation**

*Insert additional rows if needed to accommodate all DMAs draining to the BMP*

DMA Type/ID	DMA Area (square feet)	Post-Project Surface Type	Effective Imperivous Fraction, $I_f$	DMA Runoff Factor	DMA Areas x Runoff Factor	Design Storm Depth (in)	Design Capture Volume, $V_{BMP}$ (cubic feet)	Proposed Volume on Plans (cubic feet)
DMA-4	11292	Mixed Surface Types	0.88	0.70	7924.6			
	<b>11292</b>				<b>7924.6</b>	<b>0.65</b>	<b>429.2</b>	<b>432</b>

Notes:

Infiltration Trench - Design Procedure		BMP ID	Legend:	Required Entries
		DMA-5		Calculated Cells
Company Name:	GreenbergFarrow		Date:	8/18/2020
Designed by:	BB		County/City Case No.:	
<b>Design Volume</b>				
Enter the area tributary to this feature, Max = 10 acres			$A_t =$	1.00 acres
Enter $V_{BMP}$ determined from Section 2.1 of this Handbook			$V_{BMP} =$	1,722 ft <sup>3</sup>
<b>Calculate Maximum Depth of the Reservoir Layer</b>				
Enter Infiltration rate			$I =$	2.41 in/hr
Enter Factor of Safety, FS (unitless)			$FS =$	10
<i>Obtain from Table 1, Appendix A: "Infiltration Testing" of this BMP Handbook</i>				
Calculate $D_1$ .			$D_1 =$	3.62 ft
$D_1 = \frac{I \text{ (in/hr)} \times 72 \text{ hrs}}{12 \text{ (in/ft)} \times (n/100) \times FS}$			$n =$	40 %
Enter depth to historic high groundwater mark (measured from finished grade)				40 ft
Enter depth to top of bedrock or impermeable layer (measured from finished grade)				20 ft
$D_2$ is the smaller of:				
Depth to groundwater - 11 ft; & Depth to impermeable layer - 6 ft			$D_2 =$	14.0 ft
$D_{MAX}$ is the smaller value of $D_1$ and $D_2$ , must be less than or equal to 8 feet.			$D_{MAX} =$	3.6 ft
<b>Trench Sizing</b>				
Enter proposed reservoir layer depth $D_R$ , must be $\leq D_{MAX}$			$D_R =$	3.60 ft
Calculate the design depth of water, $d_w$				
Design $d_w = (D_R) \times (n/100)$			Design $d_w =$	1.44 ft
Minimum Surface Area, $A_S$			$A_S =$	1,196 ft <sup>2</sup>
$A_S = \frac{V_{BMP}}{d_w}$				
Proposed Design Surface Area			$A_D =$	1,200 ft <sup>2</sup>
Minimum Width = $D_R + 1$ foot pea gravel				4.60 ft
Sediment Control Provided? (Use pulldown)		Yes		
Geotechnical report attached? (Use pulldown)		Yes		

If the trench has been designed correctly, there should be no error messages on the spreadsheet.

**Santa Ana Watershed - BMP Design Volume,  $V_{BMP}$**

(Rev. 10-2011)

Legend:

Required Entries

Calculated Cells

*(Note this worksheet shall **only** be used in conjunction with BMP designs from the **LID BMP Design Handbook**)*

Company Name **GreenbergFarrow**

Date **8/18/2020**

Designed by **BB**

Case No

Company Project Number/Name **20200259 Perris at Pentecostal**

**BMP Identification**

BMP NAME / ID **DMA-5 Infiltration Trench**

*Must match Name/ID used on BMP Design Calculation Sheet*

**Design Rainfall Depth**

85th Percentile, 24-hour Rainfall Depth,  
from the Isohyetal Map in Handbook Appendix E

$D_{85}$  = **0.65** inches

**Drainage Management Area Tabulation**

*Insert additional rows if needed to accommodate all DMAs draining to the BMP*

DMA Type/ID	DMA Area (square feet)	Post-Project Surface Type	Effective Imperivous Fraction, $I_f$	DMA Runoff Factor	DMA Areas x Runoff Factor	Design Storm Depth (in)	Design Capture Volume, $V_{BMP}$ (cubic feet)	Proposed Volume on Plans (cubic feet)
DMA-5	43530	Mixed Surface Types	0.9	0.73	31789.2			
	<b>43530</b>				<b>31789.2</b>	<b>0.65</b>	<b>1721.9</b>	<b>1728</b>

Notes:



Infiltration Trench - Design Procedure		BMP ID	Legend:	Required Entries
		DMA-6		Calculated Cells
Company Name:	GreenbergFarrow		Date:	8/18/2020
Designed by:	BB		County/City Case No.:	
<b>Design Volume</b>				
Enter the area tributary to this feature, Max = 10 acres			$A_t =$	0.66 acres
Enter $V_{BMP}$ determined from Section 2.1 of this Handbook			$V_{BMP} =$	1,181 ft <sup>3</sup>
<b>Calculate Maximum Depth of the Reservoir Layer</b>				
Enter Infiltration rate			$I =$	2.41 in/hr
Enter Factor of Safety, FS (unitless)			$FS =$	10
<i>Obtain from Table 1, Appendix A: "Infiltration Testing" of this BMP Handbook</i>				
Calculate $D_1$ .			$D_1 =$	3.62 ft
$D_1 = \frac{I \text{ (in/hr)} \times 72 \text{ hrs}}{12 \text{ (in/ft)} \times (n/100) \times FS}$			$n =$	40 %
Enter depth to historic high groundwater mark (measured from finished grade)				40 ft
Enter depth to top of bedrock or impermeable layer (measured from finished grade)				20 ft
$D_2$ is the smaller of:				
Depth to groundwater - 11 ft; & Depth to impermeable layer - 6 ft			$D_2 =$	14.0 ft
$D_{MAX}$ is the smaller value of $D_1$ and $D_2$ , must be less than or equal to 8 feet.			$D_{MAX} =$	3.6 ft
<b>Trench Sizing</b>				
Enter proposed reservoir layer depth $D_R$ , must be $\leq D_{MAX}$			$D_R =$	3.60 ft
Calculate the design depth of water, $d_w$				
Design $d_w = (D_R) \times (n/100)$			Design $d_w =$	1.44 ft
Minimum Surface Area, $A_S$			$A_S =$	820 ft <sup>2</sup>
$A_S = \frac{V_{BMP}}{d_w}$				
Proposed Design Surface Area			$A_D =$	850 ft <sup>2</sup>
Minimum Width = $D_R + 1$ foot pea gravel				4.60 ft
Sediment Control Provided? (Use pulldown)		Yes		
Geotechnical report attached? (Use pulldown)		Yes		
If the trench has been designed correctly, there should be no error messages on the spreadsheet.				

**Santa Ana Watershed - BMP Design Volume,  $V_{BMP}$**

(Rev. 10-2011)

Legend:

Required Entries

Calculated Cells

*(Note this worksheet shall **only** be used in conjunction with BMP designs from the **LID BMP Design Handbook**)*

Company Name **GreenbergFarrow**

Date **8/18/2020**

Designed by **BB**

Case No

Company Project Number/Name **20200259 Perris at Pentecostal**

**BMP Identification**

BMP NAME / ID **DMA-6 Infiltration Trench**

*Must match Name/ID used on BMP Design Calculation Sheet*

**Design Rainfall Depth**

85th Percentile, 24-hour Rainfall Depth,  
from the Isohyetal Map in Handbook Appendix E

$D_{85} =$  **0.65** inches

**Drainage Management Area Tabulation**

*Insert additional rows if needed to accommodate all DMAs draining to the BMP*

DMA Type/ID	DMA Area (square feet)	Post-Project Surface Type	Effective Imperivous Fraction, $I_f$	DMA Runoff Factor	DMA Areas x Runoff Factor	Design Storm Depth (in)	Design Capture Volume, $V_{BMP}$ (cubic feet)	Proposed Volume on Plans (cubic feet)
DMA-6	28678	Mixed Surface Types	0.92	0.76	21795.3			
	<b>28678</b>				<b>21795.3</b>	<b>0.65</b>	<b>1180.6</b>	<b>1224</b>
		<b>Total</b>						

Notes:

Infiltration Trench - Design Procedure		BMP ID	Legend:	Required Entries
		DMA-8		Calculated Cells
Company Name:	Pentecostal LLC		Date:	30-Nov
Designed by:	BB		County/City Case No.:	
<b>Design Volume</b>				
Enter the area tributary to this feature, Max = 10 acres			$A_t =$	0 acres
Enter $V_{BMP}$ determined from Section 2.1 of this Handbook			$V_{BMP} =$	708 ft <sup>3</sup>
<b>Calculate Maximum Depth of the Reservoir Layer</b>				
Enter Infiltration rate			$I =$	2.4 in/hr
Enter Factor of Safety, FS (unitless)			$FS =$	10
<i>Obtain from Table 1, Appendix A: "Infiltration Testing" of this BMP Handbook</i>				
Calculate $D_1$ .			$D_1 =$	3.62 ft
$D_1 = \frac{I \text{ (in/hr)} \times 72 \text{ hrs}}{12 \text{ (in/ft)} \times (n/100) \times FS}$			$n =$	40 %
Enter depth to historic high groundwater mark (measured from finished grade)				40 ft
Enter depth to top of bedrock or impermeable layer (measured from finished grade)				20 ft
$D_2$ is the smaller of:				
Depth to groundwater - 11 ft; & Depth to impermeable layer - 6 ft			$D_2 =$	14.0 ft
$D_{MAX}$ is the smaller value of $D_1$ and $D_2$ , must be less than or equal to 8 feet.			$D_{MAX} =$	3.6 ft
<b>Trench Sizing</b>				
Enter proposed reservoir layer depth $D_R$ , must be $\leq D_{MAX}$			$D_R =$	3.60 ft
Calculate the design depth of water, $d_w$				
Design $d_w = (D_R) \times (n/100)$			Design $d_w =$	1.44 ft
Minimum Surface Area, $A_S$			$A_S =$	492 ft <sup>2</sup>
			$A_S = \frac{V_{BMP}}{d_w}$	
Proposed Design Surface Area			$A_D =$	500 ft <sup>2</sup>
Minimum Width = $D_R + 1$ foot pea gravel				4.60 ft
Sediment Control Provided? (Use pulldown)		Yes		
Geotechnical report attached? (Use pulldown)		Yes		
If the trench has been designed correctly, there should be no error messages on the spreadsheet.				

**Santa Ana Watershed - BMP Design Volume,  $V_{BMP}$**

(Rev. 10-2011)

Legend:

Required Entries

Calculated Cells

*(Note this worksheet shall **only** be used in conjunction with BMP designs from the **LID BMP Design Handbook**)*

Company Name **Pentecostal LLC**

Date **11/30/2021**

Designed by **BB**

Case No

Company Project Number/Name **20200259 Perris at Pentecostal**

**BMP Identification**

BMP NAME / ID **DMA-8 Infiltration Trench**

*Must match Name/ID used on BMP Design Calculation Sheet*

**Design Rainfall Depth**

85th Percentile, 24-hour Rainfall Depth,  
from the Isohyetal Map in Handbook Appendix E

$D_{85}$  = **0.65** inches

**Drainage Management Area Tabulation**

*Insert additional rows if needed to accommodate all DMAs draining to the BMP*

DMA Type/ID	DMA Area (square feet)	Post-Project Surface Type	Effective Imperivous Fraction, $I_f$	DMA Runoff Factor	DMA Areas x Runoff Factor	Design Storm Depth (in)	Design Capture Volume, $V_{BMP}$ (cubic feet)	Proposed Volume on Plans (cubic feet)
DMA-8 Pavement	14401	Concrete or Asphalt	1	0.89	12845.7			
DMA-8 LS	2110	Ornamental Landscaping	0.1	0.11	233.1			
	<b>16511</b>		<b>Total</b>		<b>13078.8</b>	<b>0.65</b>	<b>708.4</b>	<b>720</b>

Notes:



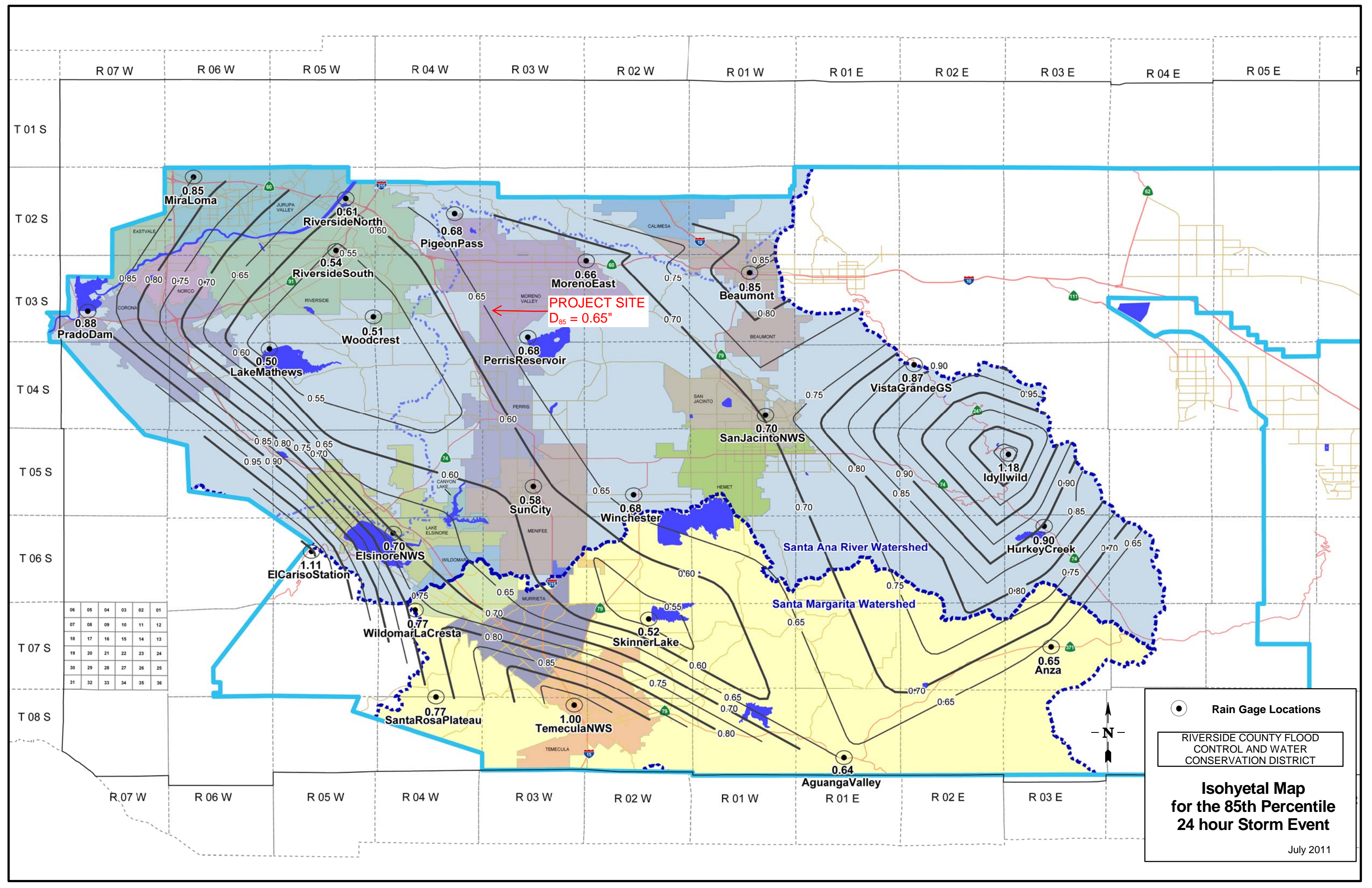

R 07 W R 06 W R 05 W R 04 W R 03 W R 02 W R 01 W R 01 E R 02 E R 03 E R 04 E R 05 E

T 01 S  
T 02 S  
T 03 S  
T 04 S  
T 05 S  
T 06 S  
T 07 S  
T 08 S

06	05	04	03	02	01
07	08	09	10	11	12
18	17	16	15	14	13
19	20	21	22	23	24
30	29	28	27	26	25
31	32	33	34	35	36

**PROJECT SITE**  
D<sub>85</sub> = 0.65"

● Rain Gage Locations

RIVERSIDE COUNTY FLOOD CONTROL AND WATER CONSERVATION DISTRICT

**Isohyetal Map for the 85th Percentile 24 hour Storm Event**

July 2011

R.07 W R.06 W R.05 W R.04 W R.03 W R.02 W R.01 W R.01 E R.02 E R.03 E



# Appendix 7: Hydromodification

*Supporting Detail Relating to Hydrologic Conditions of Concern*







# Appendix 8: Source Control

*Pollutant Sources/Source Control Checklist*



STORMWATER POLLUTANT SOURCES/SOURCE CONTROL CHECKLIST

How to use this worksheet (also see instructions in Section G of the WQMP Template):

1. Review Column 1 and identify which of these potential sources of stormwater pollutants apply to your site. Check each box that applies.
2. Review Column 2 and incorporate all of the corresponding applicable BMPs in your WQMP Exhibit.
3. Review Columns 3 and 4 and incorporate all of the corresponding applicable permanent controls and operational BMPs in your WQMP. Use the format shown in Table G.1 on page 23 of this WQMP Template. Describe your specific BMPs in an accompanying narrative, and explain any special conditions or situations that required omitting BMPs or substituting alternative BMPs for those shown here.

IF THESE SOURCES WILL BE ON THE PROJECT SITE ...	... THEN YOUR WQMP SHOULD INCLUDE THESE SOURCE CONTROL BMPs, AS APPLICABLE		
1 Potential Sources of Runoff Pollutants	2 Permanent Controls—Show on WQMP Drawings	3 Permanent Controls—List in WQMP Table and Narrative	4 Operational BMPs—Include in WQMP Table and Narrative
<input checked="" type="checkbox"/> A. On-site storm drain inlets	<input checked="" type="checkbox"/> Locations of inlets.	<input checked="" type="checkbox"/> Mark all inlets with the words “Only Rain Down the Storm Drain” or similar. Catch Basin Markers may be available from the Riverside County Flood Control and Water Conservation District, call 951.955.1200 to verify.	<input checked="" type="checkbox"/> Maintain and periodically repaint or replace inlet markings. <input checked="" type="checkbox"/> Provide stormwater pollution prevention information to new site owners, lessees, or operators. <input checked="" type="checkbox"/> See applicable operational BMPs in Fact Sheet SC-44, “Drainage System Maintenance,” in the CASQA Stormwater Quality Handbooks at <a href="http://www.cabmphandbooks.com">www.cabmphandbooks.com</a> <input checked="" type="checkbox"/> Include the following in lease agreements: “Tenant shall not allow anyone to discharge anything to storm drains or to store or deposit materials so as to create a potential discharge to storm drains.”
<input type="checkbox"/> B. Interior floor drains and elevator shaft sump pumps		<input type="checkbox"/> State that interior floor drains and elevator shaft sump pumps will be plumbed to sanitary sewer.	<input type="checkbox"/> Inspect and maintain drains to prevent blockages and overflow.
<input type="checkbox"/> C. Interior parking garages		<input type="checkbox"/> State that parking garage floor drains will be plumbed to the sanitary sewer.	<input type="checkbox"/> Inspect and maintain drains to prevent blockages and overflow.

STORMWATER POLLUTANT SOURCES/SOURCE CONTROL CHECKLIST

IF THESE SOURCES WILL BE ON THE PROJECT SITE ...	... THEN YOUR WQMP SHOULD INCLUDE THESE SOURCE CONTROL BMPs, AS APPLICABLE		
1 Potential Sources of Runoff Pollutants	2 Permanent Controls—Show on WQMP Drawings	3 Permanent Controls—List in WQMP Table and Narrative	4 Operational BMPs—Include in WQMP Table and Narrative
<input type="checkbox"/> D1. Need for future indoor & structural pest control		<input type="checkbox"/> Note building design features that discourage entry of pests.	<input type="checkbox"/> Provide Integrated Pest Management information to owners, lessees, and operators.
<input checked="" type="checkbox"/> D2. Landscape/ Outdoor Pesticide Use	<input checked="" type="checkbox"/> Show locations of native trees or areas of shrubs and ground cover to be undisturbed and retained. <input type="checkbox"/> Show self-retaining landscape areas, if any. <input checked="" type="checkbox"/> Show stormwater treatment and hydrograph modification management BMPs. (See instructions in Chapter 3, Step 5 and guidance in Chapter 5.)	<p>State that final landscape plans will accomplish all of the following.</p> <input checked="" type="checkbox"/> Preserve existing native trees, shrubs, and ground cover to the maximum extent possible. <input checked="" type="checkbox"/> Design landscaping to minimize irrigation and runoff, to promote surface infiltration where appropriate, and to minimize the use of fertilizers and pesticides that can contribute to stormwater pollution. <input checked="" type="checkbox"/> Where landscaped areas are used to retain or detain stormwater, specify plants that are tolerant of saturated soil conditions. <input checked="" type="checkbox"/> Consider using pest-resistant plants, especially adjacent to hardscape. <p>To insure successful establishment, select plants appropriate to site soils, slopes, climate, sun, wind, rain, land use, air movement, ecological consistency, and plant interactions.</p>	<input checked="" type="checkbox"/> Maintain landscaping using minimum or no pesticides. <input checked="" type="checkbox"/> See applicable operational BMPs in “What you should know for.....Landscape and Gardening” at <a href="http://rcflood.org/stormwater/Error!">http://rcflood.org/stormwater/Error!</a> <small>Hyperlink reference not valid.</small> <input type="checkbox"/> Provide IPM information to new owners, lessees and operators.

STORMWATER POLLUTANT SOURCES/SOURCE CONTROL CHECKLIST

IF THESE SOURCES WILL BE ON THE PROJECT SITE ...	... THEN YOUR WQMP SHOULD INCLUDE THESE SOURCE CONTROL BMPs, AS APPLICABLE		
1 Potential Sources of Runoff Pollutants	2 Permanent Controls—Show on WQMP Drawings	3 Permanent Controls—List in WQMP Table and Narrative	4 Operational BMPs—Include in WQMP Table and Narrative
<input checked="" type="checkbox"/> E. Pools, spas, ponds, decorative fountains, and other water features.	<input type="checkbox"/> Show location of water feature and a sanitary sewer cleanout in an accessible area within 10 feet. (Exception: Public pools must be plumbed according to County Department of Environmental Health Guidelines.)	If the Co-Permittee requires pools to be plumbed to the sanitary sewer, place a note on the plans and state in the narrative that this connection will be made according to local requirements.	<input checked="" type="checkbox"/> See applicable operational BMPs in “Guidelines for Maintaining Your Swimming Pool, Jacuzzi and Garden Fountain” at <a href="http://rcflood.org/stormwater/">http://rcflood.org/stormwater/</a>
<input type="checkbox"/> F. Food service	<input type="checkbox"/> For restaurants, grocery stores, and other food service operations, show location (indoors or in a covered area outdoors) of a floor sink or other area for cleaning floor mats, containers, and equipment.  <input type="checkbox"/> On the drawing, show a note that this drain will be connected to a grease interceptor before discharging to the sanitary sewer.	<input type="checkbox"/> Describe the location and features of the designated cleaning area.  <input type="checkbox"/> Describe the items to be cleaned in this facility and how it has been sized to insure that the largest items can be accommodated.	<input type="checkbox"/> See the brochure, “The Food Service Industry Best Management Practices for: Restaurants, Grocery Stores, Delicatessens and Bakeries” at <a href="http://rcflood.org/stormwater/">http://rcflood.org/stormwater/</a>  <b>Provide this brochure to new site owners, lessees, and operators.</b>
<input checked="" type="checkbox"/> G. Refuse areas	<input checked="" type="checkbox"/> Show where site refuse and recycled materials will be handled and stored for pickup. See local municipal requirements for sizes and other details of refuse areas.  <input checked="" type="checkbox"/> If dumpsters or other receptacles are outdoors, show how the designated area will be covered, graded, and paved to prevent run-on and show locations of berms to prevent runoff from the area.  <input type="checkbox"/> Any drains from dumpsters, compactors, and tallow bin areas shall be connected to a grease removal device before discharge to sanitary sewer.	<input checked="" type="checkbox"/> State how site refuse will be handled and provide supporting detail to what is shown on plans.  <input checked="" type="checkbox"/> State that signs will be posted on or near dumpsters with the words “Do not dump hazardous materials here” or similar.	<input checked="" type="checkbox"/> State how the following will be implemented:  <b>Provide adequate number of receptacles. Inspect receptacles regularly; repair or replace leaky receptacles. Keep receptacles covered. Prohibit/prevent dumping of liquid or hazardous wastes. Post “no hazardous materials” signs. Inspect and pick up litter daily and clean up spills immediately. Keep spill control materials available on-site. See Fact Sheet SC-34, “Waste Handling and Disposal” in the CASQA Stormwater Quality Handbooks at <a href="http://www.cabmphandbooks.com">www.cabmphandbooks.com</a></b>



STORMWATER POLLUTANT SOURCES/SOURCE CONTROL CHECKLIST

IF THESE SOURCES WILL BE ON THE PROJECT SITE ...	... THEN YOUR WQMP SHOULD INCLUDE THESE SOURCE CONTROL BMPs, AS APPLICABLE		
1 Potential Sources of Runoff Pollutants	2 Permanent Controls—Show on WQMP Drawings	3 Permanent Controls—List in WQMP Table and Narrative	4 Operational BMPs—Include in WQMP Table and Narrative
<input type="checkbox"/> H. Industrial processes.	<input type="checkbox"/> Show process area.	<input type="checkbox"/> If industrial processes are to be located on site, state: “All process activities to be performed indoors. No processes to drain to exterior or to storm drain system.”	<input type="checkbox"/> See Fact Sheet SC-10, “Non-Stormwater Discharges” in the CASQA Stormwater Quality Handbooks at <a href="http://www.cabmphandbooks.com">www.cabmphandbooks.com</a>  See the brochure “Industrial & Commercial Facilities Best Management Practices for: Industrial, Commercial Facilities” at <a href="http://rcflood.org/stormwater/">http://rcflood.org/stormwater/</a>

STORMWATER POLLUTANT SOURCES/SOURCE CONTROL CHECKLIST

IF THESE SOURCES WILL BE ON THE PROJECT SITE ...	... THEN YOUR WQMP SHOULD INCLUDE THESE SOURCE CONTROL BMPs, AS APPLICABLE		
1 Potential Sources of Runoff Pollutants	2 Permanent Controls—Show on WQMP Drawings	3 Permanent Controls—List in WQMP Table and Narrative	4 Operational BMPs—Include in WQMP Table and Narrative
<p><input checked="" type="checkbox"/> I. Outdoor storage of equipment or materials. (See rows J and K for source control measures for vehicle cleaning, repair, and maintenance.)</p>	<p><input checked="" type="checkbox"/> Show any outdoor storage areas, including how materials will be covered. Show how areas will be graded and bermed to prevent run-on or run-off from area.</p> <p><input checked="" type="checkbox"/> Storage of non-hazardous liquids shall be covered by a roof and/or drain to the sanitary sewer system, and be contained by berms, dikes, liners, or vaults.</p> <p><input checked="" type="checkbox"/> Storage of hazardous materials and wastes must be in compliance with the local hazardous materials ordinance and a Hazardous Materials Management Plan for the site.</p>	<p>Include a detailed description of materials to be stored, storage areas, and structural features to prevent pollutants from entering storm drains.</p> <p>Where appropriate, reference documentation of compliance with the requirements of Hazardous Materials Programs for:</p> <ul style="list-style-type: none"> <li>▪ Hazardous Waste Generation</li> <li>▪ Hazardous Materials Release Response and Inventory</li> <li>▪ California Accidental Release (CalARP)</li> <li>▪ Aboveground Storage Tank</li> <li>▪ Uniform Fire Code Article 80 Section 103(b) &amp; (c) 1991</li> <li>▪ Underground Storage Tank</li> </ul> <p><a href="http://www.cchealth.org/groups/hazmat/">www.cchealth.org/groups/hazmat/</a></p>	<p><input checked="" type="checkbox"/> See the Fact Sheets SC-31, “Outdoor Liquid Container Storage” and SC-33, “Outdoor Storage of Raw Materials ” in the CASQA Stormwater Quality Handbooks at <a href="http://www.cabmphandbooks.com">www.cabmphandbooks.com</a></p>

STORMWATER POLLUTANT SOURCES/SOURCE CONTROL CHECKLIST

IF THESE SOURCES WILL BE ON THE PROJECT SITE ...	... THEN YOUR WQMP SHOULD INCLUDE THESE SOURCE CONTROL BMPs, AS APPLICABLE		
1 Potential Sources of Runoff Pollutants	2 Permanent Controls—Show on WQMP Drawings	3 Permanent Controls—List in WQMP Table and Narrative	4 Operational BMPs—Include in WQMP Table and Narrative
<p><input type="checkbox"/> <b>J. Vehicle and Equipment Cleaning</b></p>	<p><input type="checkbox"/> <b>Show on drawings as appropriate:</b></p> <p>(1) Commercial/industrial facilities having vehicle/equipment cleaning needs shall either provide a covered, bermed area for washing activities or discourage vehicle/equipment washing by removing hose bibs and installing signs prohibiting such uses.</p> <p>(2) Multi-dwelling complexes shall have a paved, bermed, and covered car wash area (unless car washing is prohibited on-site and hoses are provided with an automatic shut-off to discourage such use).</p> <p>(3) Washing areas for cars, vehicles, and equipment shall be paved, designed to prevent run-on to or runoff from the area, and plumbed to drain to the sanitary sewer.</p> <p>(4) Commercial car wash facilities shall be designed such that no runoff from the facility is discharged to the storm drain system. Wastewater from the facility shall discharge to the sanitary sewer, or a wastewater reclamation system shall be installed.</p>	<p><input type="checkbox"/> <b>If a car wash area is not provided, describe any measures taken to discourage on-site car washing and explain how these will be enforced.</b></p>	<p><b>Describe operational measures to implement the following (if applicable):</b></p> <p><input type="checkbox"/> <b>Washwater from vehicle and equipment washing operations shall not be discharged to the storm drain system.</b> Refer to “Outdoor Cleaning Activities and Professional Mobile Service Providers” for many of the Potential Sources of Runoff Pollutants categories below. Brochure can be found at <a href="http://rcflood.org/stormwater/">http://rcflood.org/stormwater/</a></p> <p><input type="checkbox"/> <b>Car dealerships and similar may rinse cars with water only.</b></p>



STORMWATER POLLUTANT SOURCES/SOURCE CONTROL CHECKLIST

IF THESE SOURCES WILL BE ON THE PROJECT SITE ...	... THEN YOUR WQMP SHOULD INCLUDE THESE SOURCE CONTROL BMPs, AS APPLICABLE		
1 Potential Sources of Runoff Pollutants	2 Permanent Controls—Show on WQMP Drawings	3 Permanent Controls—List in WQMP Table and Narrative	4 Operational BMPs—Include in WQMP Table and Narrative
<p><input type="checkbox"/> <b>K. Vehicle/Equipment Repair and Maintenance</b></p>	<p><input type="checkbox"/> Accommodate all vehicle equipment repair and maintenance indoors. Or designate an outdoor work area and design the area to prevent run-on and runoff of stormwater.</p> <p><input type="checkbox"/> Show secondary containment for exterior work areas where motor oil, brake fluid, gasoline, diesel fuel, radiator fluid, acid-containing batteries or other hazardous materials or hazardous wastes are used or stored. Drains shall not be installed within the secondary containment areas.</p> <p><input type="checkbox"/> Add a note on the plans that states either (1) there are no floor drains, or (2) floor drains are connected to wastewater pretreatment systems prior to discharge to the sanitary sewer and an industrial waste discharge permit will be obtained.</p>	<p><input type="checkbox"/> State that no vehicle repair or maintenance will be done outdoors, or else describe the required features of the outdoor work area.</p> <p><input type="checkbox"/> State that there are no floor drains or if there are floor drains, note the agency from which an industrial waste discharge permit will be obtained and that the design meets that agency’s requirements.</p> <p><input type="checkbox"/> State that there are no tanks, containers or sinks to be used for parts cleaning or rinsing or, if there are, note the agency from which an industrial waste discharge permit will be obtained and that the design meets that agency’s requirements.</p>	<p>In the Stormwater Control Plan, note that all of the following restrictions apply to use the site:</p> <p><input type="checkbox"/> No person shall dispose of, nor permit the disposal, directly or indirectly of vehicle fluids, hazardous materials, or rinsewater from parts cleaning into storm drains.</p> <p><input type="checkbox"/> No vehicle fluid removal shall be performed outside a building, nor on asphalt or ground surfaces, whether inside or outside a building, except in such a manner as to ensure that any spilled fluid will be in an area of secondary containment. Leaking vehicle fluids shall be contained or drained from the vehicle immediately.</p> <p><input type="checkbox"/> No person shall leave unattended drip parts or other open containers containing vehicle fluid, unless such containers are in use or in an area of secondary containment.</p> <p>Refer to “Automotive Maintenance &amp; Car Care Best Management Practices for Auto Body Shops, Auto Repair Shops, Car Dealerships, Gas Stations and Fleet Service Operations”. Brochure can be found at <a href="http://rcflood.org/stormwater/">http://rcflood.org/stormwater/</a></p> <p>Refer to Outdoor Cleaning Activities and Professional Mobile Service Providers for many of the Potential Sources of Runoff Pollutants categories below. Brochure can be found at <a href="http://rcflood.org/stormwater/">http://rcflood.org/stormwater/</a></p>

STORMWATER POLLUTANT SOURCES/SOURCE CONTROL CHECKLIST

IF THESE SOURCES WILL BE ON THE PROJECT SITE ...	... THEN YOUR WQMP SHOULD INCLUDE THESE SOURCE CONTROL BMPs, AS APPLICABLE		
1 Potential Sources of Runoff Pollutants	2 Permanent Controls—Show on WQMP Drawings	3 Permanent Controls—List in WQMP Table and Narrative	4 Operational BMPs—Include in WQMP Table and Narrative
<input type="checkbox"/> L. Fuel Dispensing Areas	<input type="checkbox"/> Fueling areas <sup>6</sup> shall have impermeable floors (i.e., portland cement concrete or equivalent smooth impervious surface) that are: a) graded at the minimum slope necessary to prevent ponding; and b) separated from the rest of the site by a grade break that prevents run-on of stormwater to the maximum extent practicable.  <input type="checkbox"/> Fueling areas shall be covered by a canopy that extends a minimum of ten feet in each direction from each pump. [Alternative: The fueling area must be covered and the cover's minimum dimensions must be equal to or greater than the area within the grade break or fuel dispensing area <sup>1</sup> .] The canopy [or cover] shall not drain onto the fueling area.		<input type="checkbox"/> The property owner shall dry sweep the fueling area routinely. <input type="checkbox"/> See the Fact Sheet SD-30 , “Fueling Areas” in the CASQA Stormwater Quality Handbooks at <a href="http://www.cabmphandbooks.com">www.cabmphandbooks.com</a>

---

<sup>6</sup> The fueling area shall be defined as the area extending a minimum of 6.5 feet from the corner of each fuel dispenser or the length at which the hose and nozzle assembly may be operated plus a minimum of one foot, whichever is greater.

STORMWATER POLLUTANT SOURCES/SOURCE CONTROL CHECKLIST

IF THESE SOURCES WILL BE ON THE PROJECT SITE ...	... THEN YOUR WQMP SHOULD INCLUDE THESE SOURCE CONTROL BMPs, AS APPLICABLE		
1 Potential Sources of Runoff Pollutants	2 Permanent Controls—Show on WQMP Drawings	3 Permanent Controls—List in WQMP Table and Narrative	4 Operational BMPs—Include in WQMP Table and Narrative
<input type="checkbox"/> M. Loading Docks	<input type="checkbox"/> Show a preliminary design for the loading dock area, including roofing and drainage. Loading docks shall be covered and/or graded to minimize run-on to and runoff from the loading area. Roof downspouts shall be positioned to direct stormwater away from the loading area. Water from loading dock areas shall be drained to the sanitary sewer, or diverted and collected for ultimate discharge to the sanitary sewer.  <input type="checkbox"/> Loading dock areas draining directly to the sanitary sewer shall be equipped with a spill control valve or equivalent device, which shall be kept closed during periods of operation.  <input type="checkbox"/> Provide a roof overhang over the loading area or install door skirts (cowling) at each bay that enclose the end of the trailer.		<input type="checkbox"/> Move loaded and unloaded items indoors as soon as possible.  <input type="checkbox"/> See Fact Sheet SC-30, “Outdoor Loading and Unloading,” in the CASQA Stormwater Quality Handbooks at <a href="http://www.cabmphandbooks.com">www.cabmphandbooks.com</a>



STORMWATER POLLUTANT SOURCES/SOURCE CONTROL CHECKLIST

IF THESE SOURCES WILL BE ON THE PROJECT SITE ...	... THEN YOUR WQMP SHOULD INCLUDE THESE SOURCE CONTROL BMPs, AS APPLICABLE		
1 Potential Sources of Runoff Pollutants	2 Permanent Controls—Show on WQMP Drawings	3 Permanent Controls—List in WQMP Table and Narrative	4 Operational BMPs—Include in WQMP Table and Narrative
<input checked="" type="checkbox"/> N. Fire Sprinkler Test Water		<input checked="" type="checkbox"/> Provide a means to drain fire sprinkler test water to the sanitary sewer.	<input checked="" type="checkbox"/> See the note in Fact Sheet SC-41, “Building and Grounds Maintenance,” in the CASQA Stormwater Quality Handbooks at <a href="http://www.cabmphandbooks.com">www.cabmphandbooks.com</a>
<p>O. Miscellaneous Drain or Wash Water or Other Sources</p> <input type="checkbox"/> Boiler drain lines <input type="checkbox"/> Condensate drain lines <input checked="" type="checkbox"/> Rooftop equipment <input type="checkbox"/> Drainage sumps <input checked="" type="checkbox"/> Roofing, gutters, and trim. <input type="checkbox"/> Other sources		<input type="checkbox"/> Boiler drain lines shall be directly or indirectly connected to the sanitary sewer system and may not discharge to the storm drain system. <input type="checkbox"/> Condensate drain lines may discharge to landscaped areas if the flow is small enough that runoff will not occur. Condensate drain lines may not discharge to the storm drain system. Rooftop equipment with potential to produce pollutants shall be roofed and/or have secondary containment. <input type="checkbox"/> Any drainage sumps on-site shall feature a sediment sump to reduce the quantity of sediment in pumped water. <input checked="" type="checkbox"/> Avoid roofing, gutters, and trim made of copper or other unprotected metals that may leach into runoff. Include controls for other sources as specified by local reviewer.	

STORMWATER POLLUTANT SOURCES/SOURCE CONTROL CHECKLIST

IF THESE SOURCES WILL BE ON THE PROJECT SITE ...	... THEN YOUR WQMP SHOULD INCLUDE THESE SOURCE CONTROL BMPs, AS APPLICABLE		
1 Potential Sources of Runoff Pollutants	2 Permanent Controls—Show on WQMP Drawings	3 Permanent Controls—List in WQMP Table and Narrative	4 Operational BMPs—Include in WQMP Table and Narrative
<input checked="" type="checkbox"/> P. Plazas, sidewalks, and parking lots.			<input checked="" type="checkbox"/> Sweep plazas, sidewalks, and parking lots regularly to prevent accumulation of litter and debris. Collect debris from pressure washing to prevent entry into the storm drain system. Collect washwater containing any cleaning agent or degreaser and discharge to the sanitary sewer not to a storm drain.

## Appendix 9: O&M

*Operation and Maintenance Plan and Documentation of Finance, Maintenance and Recording Mechanisms*



# Appendix 10: Educational Materials

*BMP Fact Sheets, Maintenance Guidelines and Other End-User BMP Information*

### 3.1 INFILTRATION BASIN

Type of BMP	LID - Infiltration
Treatment Mechanisms	Infiltration, Evapotranspiration (when vegetated), Evaporation, and Sedimentation
Maximum Treatment Area	50 acres
Other Names	Bioinfiltration Basin

#### **Description**

An Infiltration Basin is a flat earthen basin designed to capture the design capture volume,  $V_{BMP}$ . The stormwater infiltrates through the bottom of the basin into the underlying soil over a 72 hour drawdown period. Flows exceeding  $V_{BMP}$  must discharge to a downstream conveyance system. Trash and sediment accumulate within the forebay as stormwater passes into the basin. Infiltration basins are highly effective in removing all targeted pollutants from stormwater runoff.



**Figure 1 – Infiltration Basin**

**See Appendix A, and Appendix C, Section 1 of *Basin Guidelines*, for additional requirements.**

#### **Siting Considerations**

The use of infiltration basins may be restricted by concerns over ground water contamination, soil permeability, and clogging at the site. See the applicable WQMP for any specific feasibility considerations for using infiltration BMPs. Where this BMP is being used, the soil beneath the basin must be thoroughly evaluated in a geotechnical report since the underlying soils are critical to the basin's long term performance. To protect the basin from erosion, the sides and bottom of the basin must be vegetated, preferably with native or low water use plant species.

In addition, these basins may not be appropriate for the following site conditions:

- Industrial sites or locations where spills of toxic materials may occur
- Sites with very low soil infiltration rates
- Sites with high groundwater tables or excessively high soil infiltration rates, where pollutants can affect ground water quality
- Sites with unstabilized soil or construction activity upstream
- On steeply sloping terrain
- Infiltration basins located in a fill condition should refer to Appendix A of this Handbook for details on special requirements/restrictions

## INFILTRATION BASIN BMP FACT SHEET

### Setbacks

Always consult your geotechnical engineer for site specific recommendations regarding setbacks for infiltration trenches. Recommended setbacks are needed to protect buildings, existing trees, walls, onsite or nearby wells, streams, and tanks. Setbacks should be considered early in the design process since they can affect where infiltration facilities may be placed and how deep they are allowed to be. For instance, depth setbacks can dictate fairly shallow facilities that will have a larger footprint and, in some cases, may make an infiltration basin infeasible. In that instance, another BMP must be selected.

Infiltration basins typically must be set back:

- 10 feet from the historic high groundwater (measured vertically from the bottom of the basin, as shown in Figure 2)
- 5 feet from bedrock or impermeable surface layer (measured vertically from the bottom of the basin, as shown in Figure 2)
- From all existing mature tree drip lines as indicated in Figure 2 (to protect their root structure)
- 100 feet horizontally from wells, tanks or springs

Setbacks to walls and foundations must be included as part of the Geotechnical Report. All other setbacks shall be in accordance with applicable standards of the District's *Basin Guidelines* (Appendix C).

**Figure 2 – Setback Requirements**

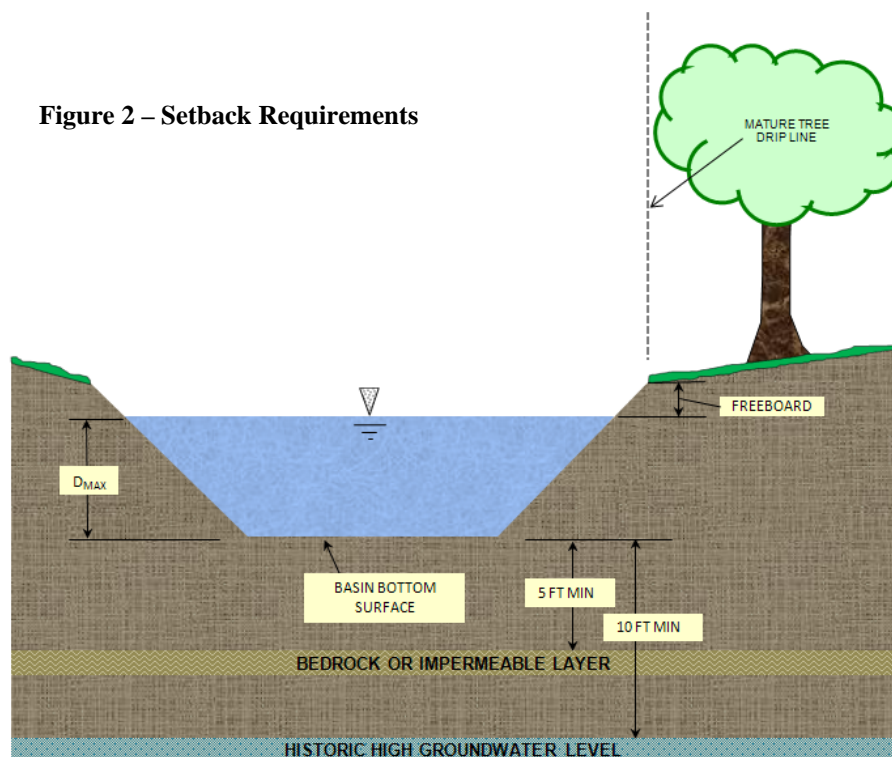

## INFILTRATION BASIN BMP FACT SHEET

### Forebay

A concrete forebay shall be provided to reduce sediment clogging and to reduce erosion. The forebay shall have a design volume of at least 0.5%  $V_{BMP}$  and a minimum 1 foot high concrete splashwall / berm. Full height notch-type weir(s), offset from the line of flow from the basin inlet to prevent short circuiting, shall be used to outlet the forebay. It is recommended that two weirs be used and that they be located on opposite sides of the forebay (see Figure 2).

### Overflow

Flows exceeding  $V_{BMP}$  must discharge to an acceptable downstream conveyance system. Where an adequate outlet is present, an overflow structure may be used. Where an embankment is present, an emergency spillway may be used instead. Overflows must be placed just above the design water surface for  $V_{BMP}$  and be near the outlet of the system. The overflow structure shall be similar to the District's Standard Drawing CB 110. Additional details may be found in the District's *Basin Guidelines* (Appendix C).

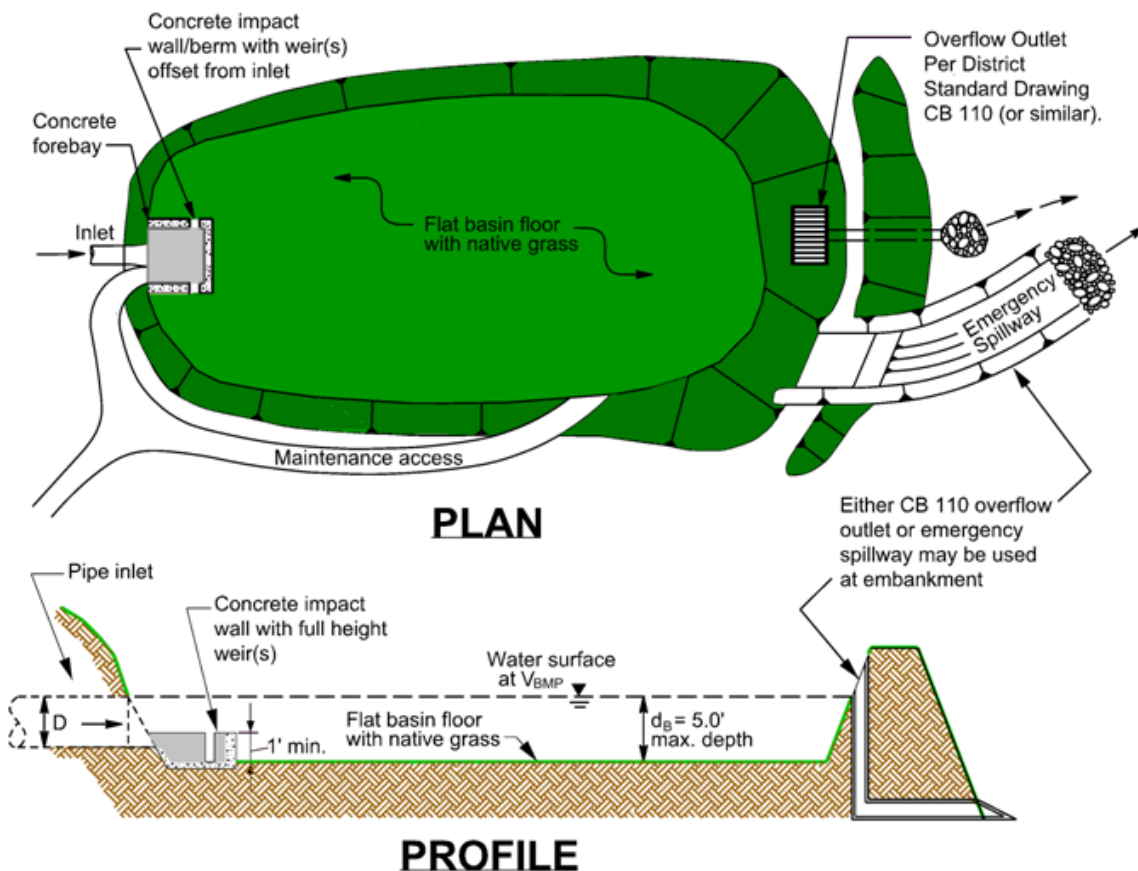

Figure 3 – Infiltration Basin



## INFILTRATION BASIN BMP FACT SHEET

### Landscaping Requirements

Basin vegetation provides erosion protection, improves sediment removal and assists in allowing infiltration to occur. The basin surface and side slopes shall be planted with native grasses. Proper landscape management is also required to ensure that the vegetation does not contribute to water pollution through pesticides, herbicides, or fertilizers. Landscaping shall be in accordance with County of Riverside Ordinance 859 and the District's *Basin Guidelines* (Appendix C), or other guidelines issued by the Engineering Authority.

### Maintenance

Normal maintenance of an infiltration basin includes the maintenance of landscaping, debris and trash removal from the surface of the basin, and tending to problems associated with standing water (vectors, odors, etc.). Significant ponding, especially more than 72 hours after an event, may indicate that the basin surface is no longer providing sufficient infiltration and requires aeration. See the District's *Basin Guidelines* (Appendix C) for additional requirements (i.e., fencing, maintenance access, etc.).

**Table 1 - Inspection and Maintenance**

Schedule	Inspection and Maintenance Activity
<p><b>Ongoing</b> including just before annual storm seasons and following rainfall events.</p>	<ul style="list-style-type: none"> <li>• Maintain vegetation as needed. Use of fertilizers, pesticides and herbicides should be strenuously avoided to ensure they don't contribute to water pollution. If appropriate native plant selections and other IPM methods are used, such products shouldn't be needed. If such projects are used,               <ul style="list-style-type: none"> <li>○ Products shall be applied in accordance with their labeling, especially in relation to application to water, and in areas subjected to flooding.</li> <li>○ Fertilizers should not be applied within 15 days before, after, or during the rain season.</li> </ul> </li> <li>• Remove debris and litter from the entire basin to minimize clogging and improve aesthetics.</li> <li>• Check for obvious problems and repair as needed. Address odor, insects, and overgrowth issues associated with stagnant or standing water in the basin bottom. There should be no long-term ponding water.</li> <li>• Check for erosion and sediment laden areas in the basin. Repair as needed. Clean forebay if needed.</li> <li>• Revegetate side slopes where needed.</li> </ul>
<p><b>Annually.</b> If possible, schedule these inspections within 72 hours after a significant rainfall.</p>	<ul style="list-style-type: none"> <li>• Inspection of hydraulic and structural facilities. Examine the inlet for blockage, the embankment and spillway integrity, as well as damage to any structural element.</li> <li>• Check for erosion, slumping and overgrowth. Repair as needed.</li> <li>• Check basin depth for sediment build up and reduced total capacity. Scrape bottom as needed and remove sediment. Restore to original cross-section and infiltration rate. Replant basin vegetation.</li> <li>• Verify the basin bottom is allowing acceptable infiltration. Use a disc or other method to aerate basin bottom only if there is actual significant loss of infiltrative capacity, rather than on a routine basis<sup>1</sup>.</li> <li>• No water should be present 72 hours after an event. No long term standing water should be present at all. No algae formation should be visible. Correct problem as needed.</li> </ul>
<p><b>1. CA Stormwater BMP Handbook for New Development and Significant Redevelopment</b></p>	

## INFILTRATION BASIN BMP FACT SHEET

**Table 2 - Design and Sizing Criteria for Infiltration Basins**

Design Parameter	Infiltration Basin
Design Volume	$V_{BMP}$
Forebay Volume	0.5% $V_{BMP}$
Drawdown time (maximum)	72 hours
Maximum tributary area	50 acres <sup>2</sup>
Minimum infiltration rate	Must be sufficient to drain the basin within the required Drawdown time over the life of the BMP. The WQMP may include specific requirements for minimum tested infiltration rates.
Maximum Depth	5 feet
Spillway erosion control	Energy dissipators to reduce velocities <sup>1</sup>
Basin Slope	0%
Freeboard (minimum)	1 foot <sup>1</sup>
Historic High Groundwater Setback (max)	10 feet
Bedrock/impermeable layer setback (max)	5 feet
Tree setbacks	Mature tree drip line must not overhang the basin
Set back from wells, tanks or springs	100 feet
Set back from foundations	As recommended in Geotechnical Report
<ol style="list-style-type: none"> <li>1. Ventura County's Technical Guidance Manual for Stormwater Quality Control Measures</li> <li>2. CA Stormwater BMP Handbook for New Development and Significant Redevelopment</li> </ol>	

*Note: The information contained in this BMP Factsheet is intended to be a summary of design considerations and requirements. Additional information which applies to all detention basins may be found in the District's Basin Guidelines (Appendix C). In addition, information herein may be superseded by other guidelines issued by the co-permittee.*

### **INFILTRATION BASIN SIZING PROCEDURE**

1. Find the Design Volume,  $V_{BMP}$ .
  - a) Enter the Tributary Area,  $A_T$ .
  - b) Enter the Design Volume,  $V_{BMP}$ , determined from Section 2.1 of this Handbook.
2. Determine the Maximum Depth.
  - a) Enter the infiltration rate. The infiltration rate shall be established as described in Appendix A: "Infiltration Testing".
  - b) Enter the design Factor of Safety from Table 1 in Appendix A: "Infiltration Testing".
  - c) The spreadsheet will determine  $D_1$ , the maximum allowable depth of the basin based on the infiltration rate along with the maximum drawdown time (72 hours) and the Factor of Safety.

$$D_1 = [(t) \times (I)] / 12s$$

Where     $I$  = site infiltration rate (in/hr)  
            $s$  = safety factor  
            $t$  = drawdown time (maximum 72 hours)

## INFILTRATION BASIN BMP FACT SHEET

- d) Enter the depth of freeboard.
- e) Enter the depth to the historic high groundwater level measured from the top of the basin.
- f) Enter the depth to the top of bedrock or other impermeable layer measured from the finished grade.
- g) The spreadsheet will determine  $D_2$ , the total basin depth (including freeboard, if used) of the basin, based on restrictions to the depth by groundwater and an impermeable layer.

$$D_2 = \text{Depth to groundwater} - (10 + \text{freeboard}) \text{ (ft);}$$

**or**

$$D_2 = \text{Depth to impermeable layer} - (5 + \text{freeboard}) \text{ (ft)}$$

Whichever is least.

- h) The spreadsheet will determine the maximum allowable effective depth of basin,  $D_{MAX}$ , based on the smallest value between  $D_1$  and  $D_2$ .  $D_{MAX}$  is the maximum depth of water only and does not include freeboard.  $D_{MAX}$  shall not exceed 5 feet.

### 3. Basin Geometry

- a) Enter the basin side slopes,  $z$  (no steeper than 4:1).
- b) Enter the proposed basin depth,  $d_B$  excluding freeboard.
- c) The spreadsheet will determine the minimum required surface area of the basin:

$$A_s = V_{BMP} / d_B$$

Where  $A_s$  = minimum area required ( $\text{ft}^2$ )

$V_{BMP}$  = volume of the infiltration basin ( $\text{ft}^3$ )

$d_B$  = proposed depth not to exceed maximum allowable depth,  $D_{MAX}$  (ft)

- d) Enter the proposed bottom surface area. This area shall not be less than the minimum required surface area.

### 4. Forebay

A concrete forebay with a design volume of at least 0.5%  $V_{BMP}$  and a minimum 1 foot high concrete splashwall shall be provided. Full-height rectangular weir(s) shall be used to outlet the forebay. The weir(s) must be offset from the line of flow from the basin inlet. It is recommended that two weirs be used and that they be located on opposite sides of the forebay (see Figure 2).

- a) The spreadsheet will determine the minimum required forebay volume based on 0.5%  $V_{BMP}$ .
- b) Enter the proposed depth of the forebay berm/splashwall (1foot minimum).
- c) The spreadsheet will determine the minimum required forebay surface area.
- d) Enter the width of rectangular weir to be used (minimum 1.5 inches). Weir width should be established based on a 5 minute drawdown time.

## 3.2 INFILTRATION TRENCH

Type of BMP	LID - Infiltration
Treatment Mechanisms	Infiltration, Evapotranspiration (when vegetated), Evaporation
Maximum Drainage Area	10-acres
Other Names	None

### **Description**

Infiltration trenches are shallow excavated areas that are filled with rock material to create a subsurface reservoir layer. The trench is sized to store the design capture volume,  $V_{BMP}$ , in the void space between the rocks. Over a period of 72 hours, the stormwater infiltrates through the bottom of the trench into the surrounding soil. Infiltration basins are highly effective in removing all targeted pollutants from stormwater runoff.

Figure 1 shows the components of an infiltration trench. The section shows the reservoir layer and observation well, which is used to monitor water depth. An overflow pipe that is used to bypass flows once the trench fills with stormwater is also shown.

### **Site Considerations**

#### **Location**

The use of infiltration trenches may be restricted by concerns over groundwater contamination, soil permeability, and clogging at the site. See the applicable WQMP for any specific feasibility considerations for using infiltration BMPs. Where this BMP is being used, the soil beneath the basin must be thoroughly evaluated in a geotechnical report since the underlying soils are critical to the basin's long term performance. These basins may not be appropriate for the following site conditions:

- Industrial sites or locations where spills of toxic materials may occur.
- Sites with very low soil infiltration rates.
- Sites with high groundwater tables or excessively high soil infiltration rates, where pollutants can affect groundwater quality.
- Sites with unstabilized soil or construction activity upstream.
- On steeply sloping terrain.
- Infiltration trenches located in a fill condition should refer to Appendix A of this Handbook for details on special requirements/restrictions.

This BMP has a flat surface area, so it may be challenging to incorporate into steeply sloping terrain.



## INFILTRATION TRENCH BMP FACT SHEET

### Setbacks

Always consult your geotechnical engineer for site specific recommendations regarding setbacks for infiltration trenches. Recommended setbacks are needed to protect buildings, walls, onsite or nearby wells, streams, and tanks. Setbacks should be considered early in the design process as they affect where infiltration facilities may be placed and how deep they are allowed to be. For instance, depth setbacks can dictate fairly shallow facilities that will have a larger footprint and, in some cases, may make an infiltration trench infeasible. In that instance, another BMP must be selected.

In addition to setbacks recommended by the geotechnical engineer, infiltration trenches must be set back:

- 10 feet from the historic high groundwater mark (measured vertically from the bottom of the trench, as shown in Figure 1)
- 5 feet from bedrock or impermeable surface layer (measured vertically from the bottom of the trench, as shown in Figure 1)
- From all mature tree drip lines as indicated in Figure 1
- 100 feet horizontally from wells, tanks or springs

Setbacks to walls and foundations must be included as part of the Geotechnical Report.

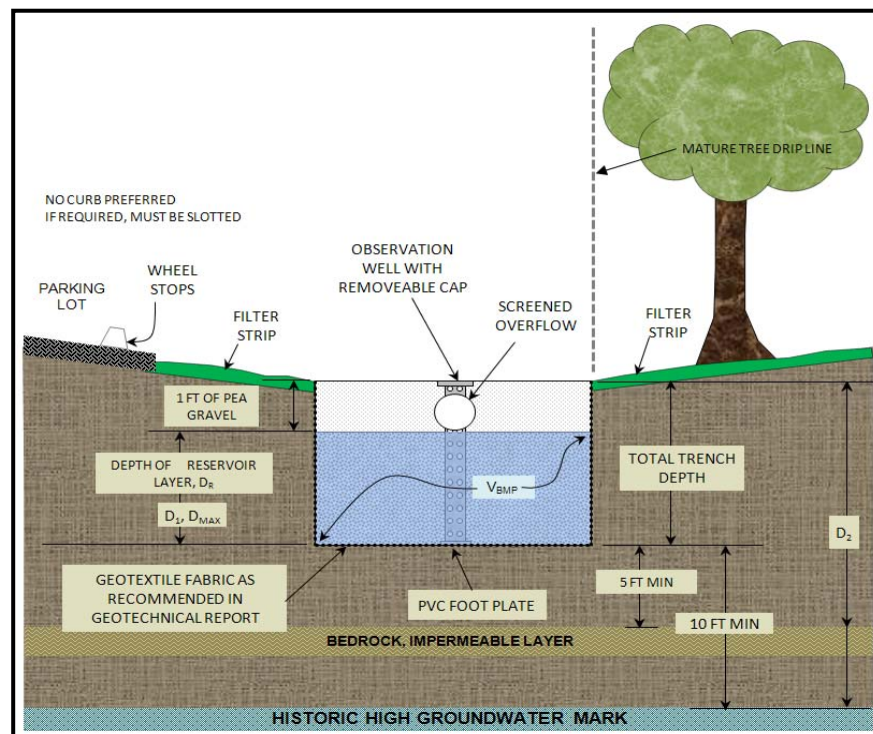

**Figure 1** Section View of an Infiltration Trench

## INFILTRATION TRENCH BMP FACT SHEET

### Sediment Control

Infiltration BMPs have the risk of becoming plugged over time. To prevent this, sediment must be removed before stormwater enters the trench. Both sheet and concentrated flow types have requirements that should be considered in the design of an infiltration trench.

When sheet type flows approach the trench along its length (as illustrated in Figure 2), a vegetated filter strip should be placed between the trench

and the upstream drainage area. The filter strip must be a minimum of 5 feet wide and planted with grasses (preferably native) or covered with mulch.

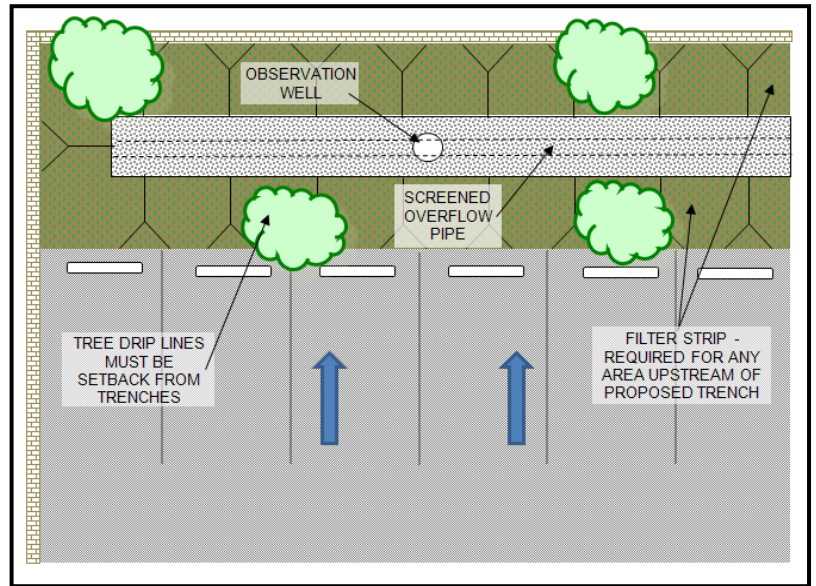

**Figure 2** Plan View, Sheet Type Flows

Concentrated flows require a different approach. A 2004 Caltrans BMP Retrofit Report found that flow spreaders recommended in many water quality manuals are ineffective in distributing concentrated flows. As such, concentrated flows should either be directed toward a traditional vegetated swale (as shown on the right side of Figure 3) or to catch basin filters that can remove litter and sediment. Catch basins must discharge runoff as surface flow above the trench; they cannot outlet directly into the reservoir layer of the infiltration trench. If catch basins are used, the short and long term costs of the catch basin filters should be considered.

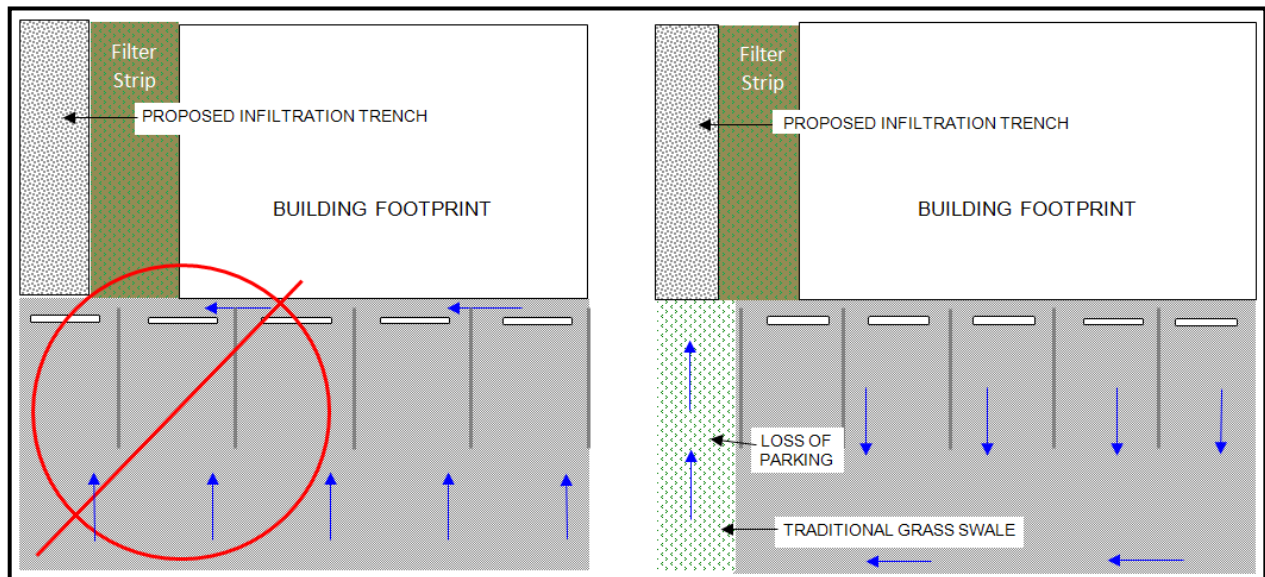

**Figure 3** Plan View, Concentrated Flows

# INFILTRATION TRENCH BMP FACT SHEET

## **Additional Considerations**

### **Class V Status**

In certain circumstances, for example, if an infiltration trench is “deeper than its widest surface dimension,” or includes an assemblage of perforated pipes, drain tiles, or other similar mechanisms intended to distribute fluids below the surface of the ground, it would probably be considered by the EPA to be a Class V injection well. Class V injection wells are subject to regulations and reporting requirements via the Underground Injection Control (UIC) Program. To ensure that infiltration trenches are not considered Class V wells, the design procedure in this manual requires that the trench not be deeper than it is wide.

### **Geotechnical Report**

A geotechnical report must be included for all infiltration trenches. Appendix A of this Handbook entitled “Infiltration Testing Guidelines”, details which types of infiltration tests are acceptable and how many tests or boring logs must be performed. A Geotechnical Report must be submitted in support of all infiltration trenches. Setbacks to walls and foundations must be included in the Geotechnical Report.

### **Observation Wells**

One or more observation wells should be provided. The observation well consists of a vertical section of perforated pipe, 4 to 6 inches in diameter, installed flush with top of trench on a foot plate and have a locking, removable cap.

### **Overflow**

An overflow route is needed to bypass storm flows larger than the  $V_{BMP}$  or in the event of clogging. Overflow systems must connect to an acceptable discharge point such as a downstream conveyance system.

### **Maintenance Access**

Normal maintenance of an infiltration trench includes maintenance of the filter strip as well as debris and trash removal from the surface of the trench and filter strip. More substantial maintenance requiring vehicle access may be required every 5 to 10 years. Vehicular access along the length of the swale should be provided to all infiltration trenches. It is preferred that trenches be placed longitudinally along a street or adjacent to a parking lot area. These conditions have high visibility which makes it more likely that the trench will be maintained on a regular basis.

## INFILTRATION TRENCH BMP FACT SHEET

### Inspection and Maintenance

Schedule	Inspection and Maintenance Activity
Every two weeks, or as often as necessary to maintain a pleasant appearance	<ul style="list-style-type: none"> <li>- Maintain adjacent landscaped areas. Remove clippings from landscape maintenance activities.</li> <li>- Remove trash &amp; debris</li> </ul>
3 days after Major Storm Events	<ul style="list-style-type: none"> <li>- Check for surface ponding. If ponding is only above the trench, remove, wash and replace pea gravel. May be needed every 5-10 years.</li> <li>- Check observation well for ponding. If the trench becomes plugged, remove rock materials. Provide a fresh infiltration surface by excavating an additional 2-4 inches of soil. Replace the rock materials.</li> </ul>

### Design and Sizing Criteria

Design Parameter	Design Criteria
Design Volume	$V_{BMP}$
Design Drawdown time	72 hrs
Maximum Tributary Drainage Area	10 acres
Maximum Trench Depth	8.0 ft
Width to Depth Ratio	Width must be greater than depth
Reservoir Rock Material	AASHTO #3 or 57 material or a clean, washed aggregate 1 to 3-in diameter equivalent
Filter Strip Width	Minimum of 5 feet in the direction of flow for all areas draining to trench
Filter Strip Slope	Max slope = 1%
Filter Strip Materials	Mulch or grasses (non-mowed variety preferred)
Historic High Groundwater Mark	10 ft or more below bottom of trench
Bedrock/Impermeable Layer Setback	5 ft or more below bottom of trench
Tree Setbacks	Mature tree drip line must not overhang the trench
Trench Lining Material	As recommended in Geotechnical Report



## INFILTRATION TRENCH BMP FACT SHEET

### Infiltration Trench Design Procedure

1. Enter the area tributary to the trench, maximum drainage area is 10 acres.
2. Enter the Design Volume,  $V_{BMP}$ , determined from Section 2.1 of this Handbook.
3. Enter the site infiltration rate, found in the geotechnical report.
4. Enter the factor of safety from Table 1 of Appendix A, Infiltration Testing.
5. Determine the maximum reservoir layer depth,  $D_{MAX}$ . The value is obtained by taking the smaller of two depth equations but may never exceed 8 feet. The first depth,  $D_1$  is related to the infiltration rate of the soil. The second depth,  $D_2$ , is related to required setbacks to groundwater, bedrock/impermeable layer. These parameters are shown in Figure 1.

Calculate  $D_1$ .

$$D_1 = \frac{I \left( \frac{\text{in}}{\text{hr}} \right) \times 72 \text{ (hrs)}}{12 \left( \frac{\text{in}}{\text{ft}} \right) \times n/100 \times FS}$$

Where:

- I = site infiltration rate (in/hr), found in the geotechnical report
- FS = factor of safety, refer to Appendix A - Infiltration Testing
- n = porosity of the trench material, 40%

Calculate  $D_2$ . Enter the depth to the seasonal high groundwater and bedrock/impermeable layer measured from the finished grade. The spreadsheet checks the minimum setbacks shown in Figure 1 and selects the smallest value. The equations are listed below for those doing hand calculations.

Minimum Setbacks (includes 1 foot for pea gravel):

- = Depth to historic high groundwater mark - 11 feet
- = Depth to impermeable layer - 6 feet

$D_2$  is the smaller of the two values.

$D_{MAX}$  is the smaller value of  $D_1$  and  $D_2$ , and must be less than or equal to 8 feet.

6. Enter the proposed reservoir layer depth,  $D_R$ . The value must be no greater than  $D_{MAX}$ .

## INFILTRATION TRENCH BMP FACT SHEET

7. Find the required surface area of the trench,  $A_S$ . Once  $D_R$  is entered, the spreadsheet will calculate the corresponding depth of water and the minimum surface area of the trench.

$$\text{Design } d_W = D_R \times (n/100) \qquad A_S = \frac{V_{BMP}}{\text{Design } d_W}$$

Where:

$A_S$  = minimum area required (ft<sup>2</sup>)

$V_{BMP}$  = BMP storage volume (ft<sup>3</sup>)

Design  $d_W$  = Depth of water in reservoir layer (ft)

8. Enter the proposed design surface area; it must be greater than the minimum surface area.
9. Calculate the minimum trench width. This is to ensure that EPA's Class V Injection well status is not triggered. The total trench depth (shown in Figure 1) includes the upper foot where the overflow pipe is located. The minimum surface dimension is  $D_R + 1$  foot.

### **Additional Items**

The following items detailed in the preceding sections should also be addressed in the design.

- Sediment Control
- Geotechnical Report
- Observation well(s)
- Overflow

## INFILTRATION TRENCH BMP FACT SHEET

### Reference Material

California Stormwater Quality Association. California Stormwater BMP Handbook New Development and Redevelopment. 2003.

County of Los Angeles Department of Public Works. Stormwater BMP Best Management Practice Design and Maintenance Manual for Publicly Maintained Storm Drain Systems. Los Angeles, CA, 2009.

LandSaver Stormwater Management System. Tech Sheet - Porosity of Structural Backfill. 2006.

United States Environmental Protection Agency. Office of Water, Washington D.C. Storm Water Technology Fact Sheet Vegetated Swales. 1999.

United States Environmental Protection Agency. Office of Water. Memorandum on Clarification on Which Stormwater Infiltration Practices/technologies Have the Potential to Be Regulated as "Class V" Wells by Underground Injection Control Program. By Linda Boornazian and Steve Heare. Washington D.C., 2008.

Ventura Countywide Stormwater Quality Management Program. Land Development Guidelines Biofilter Fact Sheet. Ventura, CA, 2001.

Ventura Countywide Stormwater Quality Management Program. Technical Guidance Manual for Stormwater Quality Control Measures. Ventura, CA, 2002.

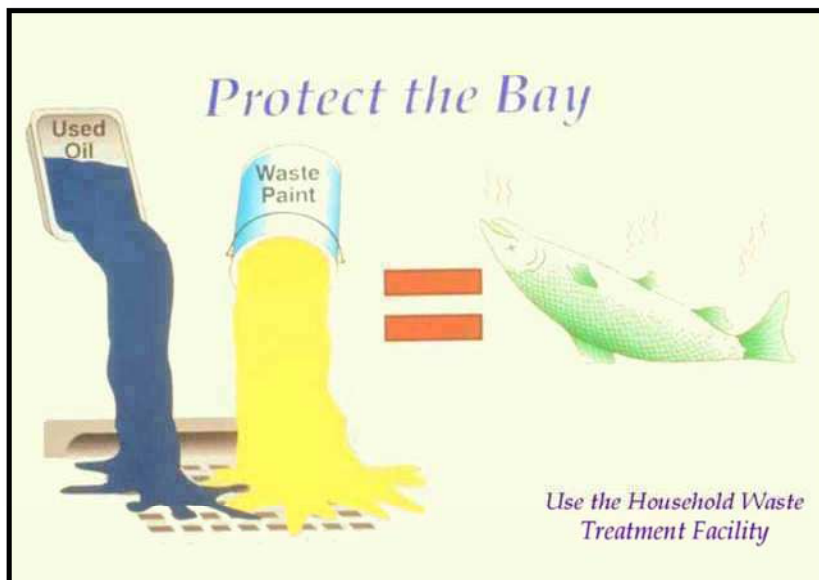

Graphic by: Margie Winter

## Description

Non-stormwater discharges are those flows that do not consist entirely of stormwater. For municipalities non-stormwater discharges present themselves in two situations. One is from fixed facilities owned and/or operated by the municipality. The other situation is non-stormwater discharges that are discovered during the normal operation of a field program. Some non-stormwater discharges do not include pollutants and may be discharged to the storm drain. These include uncontaminated groundwater and natural springs. There are also some non-stormwater discharges that typically do not contain pollutants and may be discharged to the storm drain with conditions. These include car washing, and surface cleaning. However, there are certain non-stormwater discharges that pose environmental concern. These discharges may originate from illegal dumping or from internal floor drains, appliances, industrial processes, sinks, and toilets that are connected to the nearby storm drainage system. These discharges (which may include: process waste waters, cooling waters, wash waters, and sanitary wastewater) can carry substances (such as paint, oil, fuel and other automotive fluids, chemicals and other pollutants) into storm drains. The ultimate goal is to effectively eliminate non-stormwater discharges to the stormwater drainage system through implementation of measures to detect, correct, and enforce against illicit connections and illegal discharges.

## Approach

The municipality must address non-stormwater discharges from its fixed facilities by assessing the types of non-stormwater discharges and implementing BMPs for the discharges determined to pose environmental concern. For field programs

## Objectives

- Contain
- Educate
- Reduce/Minimize

## Targeted Constituents

Sediment	<input checked="" type="checkbox"/>
Nutrients	<input checked="" type="checkbox"/>
Trash	<input checked="" type="checkbox"/>
Metals	<input checked="" type="checkbox"/>
Bacteria	<input checked="" type="checkbox"/>
Oil and Grease	<input checked="" type="checkbox"/>
Organics	<input checked="" type="checkbox"/>
Oxygen Demanding	<input checked="" type="checkbox"/>





the field staff must be trained to know what to look for regarding non-stormwater discharges and the procedures to follow in investigating the detected discharges.

## ***Suggested Protocols***

### **Fixed Facility**

#### *General*

- Post “No Dumping” signs with a phone number for reporting dumping and disposal. Signs should also indicate fines and penalties for illegal dumping.
- Stencil storm drains, where applicable, to prevent illegal disposal of pollutants. Storm drain inlets should have messages such as “Dump No Waste Drains to Stream” stenciled next to them to warn against ignorant or intentional dumping of pollutants into the storm drainage system.
- Landscaping and beautification efforts of hot spots might also discourage future dumping, as well as provide open space and increase property values.
- Lighting or barriers may also be needed to discourage future dumping.

#### *Illicit Connections*

- Locate discharges from the fixed facility drainage system to the municipal storm drain system through review of “as-built” piping schematics.
- Use techniques such as smoke testing, dye testing and television camera inspection (as noted below) to verify physical connections.
- Isolate problem areas and plug illicit discharge points.

#### *Visual Inspection and Inventory*

- Inventory and inspect each discharge point during dry weather.
- Keep in mind that drainage from a storm event can continue for several days following the end of a storm and groundwater may infiltrate the underground stormwater collection system. Also, non-stormwater discharges are often intermittent and may require periodic inspections.

#### *Review Infield Piping*

- Review the “as-built” piping schematic as a way to determine if there are any connections to the stormwater collection system.
- Inspect the path of floor drains in older buildings.

#### *Smoke Testing*

- Smoke testing of wastewater and stormwater collection systems is used to detect connections between the two systems.

- During dry weather the stormwater collection system is filled with smoke and then traced to sources. The appearance of smoke at the base of a toilet indicates that there may be a connection between the sanitary and the stormwater system.

### *Dye Testing*

- A dye test can be performed by simply releasing a dye into either your sanitary or process wastewater system and examining the discharge points from the stormwater collection system for discoloration.

### *TV Inspection of Storm Sewer*

- TV Cameras can be employed to visually identify illicit connections to the fixed facility storm drain system.

### *Illegal Dumping*

- Regularly inspect and clean up hot spots and other storm drainage areas where illegal dumping and disposal occurs.
- Clean up spills on paved surfaces with as little water as possible. Use a rag for small spills, a damp mop for general cleanup, and absorbent material for larger spills. If the spilled material is hazardous, then the used cleanup materials are also hazardous and must be sent to a certified laundry (rags) or disposed of as hazardous waste.
- Never hose down or bury dry material spills. Sweep up the material and dispose of properly.
- Use adsorbent materials on small spills rather than hosing down the spill. Remove the adsorbent materials promptly and dispose of properly.
- For larger spills, a private spill cleanup company or Hazmat team may be necessary.
- See fact sheet SC-11 Spill Prevention, Control, and Clean Up.

## **Field Program**

### *General*

- Develop clear protocols and lines of communication for effectively prohibiting non-stormwater discharges, especially ones that involve more than one jurisdiction and those that are not classified as hazardous, which are often not responded to as effectively as they need to be.
- Stencil storm drains, where applicable, to prevent illegal disposal of pollutants. Storm drain inlets should have messages such as "Dump No Waste Drains to Stream" stenciled next to them to warn against ignorant or intentional dumping of pollutants into the storm drainage system.
- See SC-74 Stormwater Drainage System Maintenance for additional information.

*Field Inspection*

- Regularly inspect and clean up hot spots and other storm drainage areas where illegal dumping and disposal occurs.
- During routine field program maintenance field staff should look for evidence of illegal discharges or illicit connection:
  - Is there evidence of spills such as paints, discoloring, etc.
  - Are there any odors associated with the drainage system
  - Record locations of apparent illegal discharges/illicit connections and notify appropriate investigating agency.
- If trained, conduct field investigation of non-stormwater discharges to determine whether they pose a threat to water quality.

*Recommended Complaint Investigation Equipment*

- Field Screening Analysis
  - pH paper or meter
  - Commercial stormwater pollutant screening kit that can detect for reactive phosphorus, nitrate nitrogen, ammonium nitrogen, specific conductance, and turbidity
  - Sample jars
  - Sample collection pole
  - A tool to remove access hole covers
- Laboratory Analysis
  - Sample cooler
  - Ice
  - Sample jars and labels
  - Chain of custody forms.
- Documentation
  - Camera
  - Notebook
  - Pens
  - Notice of Violation forms

- Educational materials

## *Reporting*

- A database is useful for defining and tracking the magnitude and location of the problem.
- Report prohibited non-stormwater discharges observed during the course of normal daily activities so they can be investigated, contained and cleaned up or eliminated.
- Document that non-stormwater discharges have been eliminated by recording tests performed, methods used, dates of testing, and any onsite drainage points observed.
- Maintain documentation of illicit connection and illegal dumping incidents, including significant conditionally exempt discharges that are not properly managed.

## *Enforcement*

- Educate the responsible party if identified on the impacts of their actions, explain the stormwater requirements, and provide information regarding Best Management Practices (BMP), as appropriate. Initiate follow-up and/or enforcement procedures.
- If an illegal discharge is traced to a commercial, residential or industrial source, conduct the following activities or coordinate the following activities with the appropriate agency:
  - Contact the responsible party to discuss methods of eliminating the non-stormwater discharge, including disposal options, recycling, and possible discharge to the sanitary sewer (if within POTW limits).
  - Provide information regarding BMPs to the responsible party, where appropriate.
  - Begin enforcement procedures, if appropriate.
  - Continue inspection and follow-up activities until the illicit discharge activity has ceased.
- If an illegal discharge is traced to a commercial or industrial activity, coordinate information on the discharge with the jurisdiction's commercial and industrial facility inspection program.

## *Training*

- Train technical staff to identify and document illegal dumping incidents.
- Well-trained employees can reduce human errors that lead to accidental releases or spills. The employee should have the tools and knowledge to immediately begin cleaning up a spill if one should occur. Employees should be familiar with the Spill Prevention Control and Countermeasure Plan.
- Train employees to identify non-stormwater discharges and report them to the appropriate departments.
- Train staff who have the authority to conduct surveillance and inspections, and write citations for those caught illegally dumping.



- Train municipal staff responsible for surveillance and inspection in the following:
  - OSHA-required Health and Safety Training (29 CFR 1910.120) plus annual refresher training (as needed).
  - OSHA Confined Space Entry training (Cal-OSHA Confined Space, Title 8 and federal OSHA 29 CFR 1910.146).
  - Procedural training (field screening, sampling, smoke/dye testing, TV inspection).
- Educate the identified responsible party on the impacts of his or her actions.

***Spill Response and Prevention***

- See SC-11 Spill Prevention Control and Clean Up

***Other Considerations***

- The elimination of illegal dumping is dependent on the availability, convenience, and cost of alternative means of disposal. The cost of fees for dumping at a proper waste disposal facility are often more than the fine for an illegal dumping offense, thereby discouraging people from complying with the law. The absence of routine or affordable pickup service for trash and recyclables in some communities also encourages illegal dumping. A lack of understanding regarding applicable laws or the inadequacy of existing laws may also contribute to the problem.
- Municipal codes should include sections prohibiting the discharge of soil, debris, refuse, hazardous wastes, and other pollutants into the storm drain system.
- Many facilities do not have accurate, up-to-date schematic drawings.
- Can be difficult to locate illicit connections especially if there is groundwater infiltration.

**Requirements*****Costs***

- Eliminating illicit connections can be expensive especially if structural modifications are required such re-plumbing cross connections under an existing slab.
- Minor cost to train field crews regarding the identification of non-stormwater discharges. The primary cost is for a fully integrated program to identify and eliminate illicit connections and illegal dumping. However, by combining with other municipal programs (i.e. pretreatment program) cost may be lowered.
- Municipal cost for containment and disposal may be borne by the discharger.

***Maintenance***

Not applicable

## Supplemental Information

### *Further Detail of the BMP*

*What constitutes a “non-stormwater” discharge?*

- Non-stormwater discharges are discharges not made up entirely of stormwater and include water used directly in the manufacturing process (process wastewater), air conditioning condensate and coolant, non-contact cooling water, cooling equipment condensate, outdoor secondary containment water, vehicle and equipment wash water, landscape irrigation, sink and drinking fountain wastewater, sanitary wastes, or other wastewaters.

### *Permit Requirements*

- Current municipal NPDES permits require municipalities to effectively prohibit non-stormwater discharges unless authorized by a separate NPDES permit or allowed in accordance with the current NPDES permit conditions. Typically the current permits allow certain non-stormwater discharges in the storm drain system as long as the discharges are not significant sources of pollutants. In this context the following non-stormwater discharges are typically allowed:
  - Diverted stream flows;
  - Rising found waters;
  - Uncontaminated ground water infiltration (as defined at 40 CFR 35.2005(20));
  - Uncontaminated pumped ground water;
  - Foundation drains;
  - Springs;
  - Water from crawl space pumps;
  - Footing drains;
  - Air conditioning condensation;
  - Flows from riparian habitats and wetlands;
  - Water line and hydrant flushing ;
  - Landscape irrigation;
  - Planned and unplanned discharges from potable water sources;
  - Irrigation water;
  - Individual residential car washing; and
  - Lawn watering.

Municipal facilities subject to industrial general permit requirements must include a certification that the stormwater collection system has been tested or evaluated for the presence of non-stormwater discharges. The state's General Industrial Stormwater Permit requires that non-stormwater discharges be eliminated prior to implementation of the facility's SWPPP.

### *Illegal Dumping*

- Establish a system for tracking incidents. The system should be designed to identify the following:
  - Illegal dumping hot spots
  - Types and quantities (in some cases) of wastes
  - Patterns in time of occurrence (time of day/night, month, or year)
  - Mode of dumping (abandoned containers, "midnight dumping" from moving vehicles, direct dumping of materials, accidents/spills)
  - Responsible parties

### *Outreach*

One of the keys to success of reducing or eliminating illegal dumping is increasing the number of people on the street who are aware of the problem and who have the tools to at least identify the incident, if not correct it. There are a number of ways of accomplishing this:

- Train municipal staff from all departments (public works, utilities, street cleaning, parks and recreation, industrial waste inspection, hazardous waste inspection, sewer maintenance) to recognize and report the incidents.
- Deputize municipal staff who may come into contact with illegal dumping with the authority to write illegal dumping tickets for offenders caught in the act (see below).
- Educate the public. As many as 3 out of 4 people do not understand that in most communities the storm drain does not go to the wastewater treatment plant. Unfortunately, with the heavy emphasis in recent years on public education about solid waste management, including recycling and household hazardous waste, the sewer system (both storm and sanitary) has been the likely recipient of cross-media transfers of waste.
- Provide the public with a mechanism for reporting incidents such as a hot line and/or door hanger (see below).
- Help areas where incidents occur more frequently set up environmental watch programs (like crime watch programs).
- Train volunteers to notice and report the presence and suspected source of an observed pollutant to the appropriate public agency.

*What constitutes a “non-stormwater” discharge?*

- Non-stormwater discharges are discharges not made up entirely of stormwater and include water used directly in the manufacturing process (process wastewater), air conditioning condensate and coolant, non-contact cooling water, cooling equipment condensate, outdoor secondary containment water, vehicle and equipment wash water, landscape irrigation, sink and drinking fountain wastewater, sanitary wastes, or other wastewaters.

*Permit Requirements*

- Current municipal NPDES permits require municipalities to effectively prohibit non-stormwater discharges unless authorized by a separate NPDES permit or allowed in accordance with the current NPDES permit conditions. Typically the current permits allow certain non-stormwater discharges in the storm drain system as long as the discharges are not significant sources of pollutants. In this context the following non-stormwater discharges are typically allowed:
  - Diverted stream flows;
  - Rising found waters;
  - Uncontaminated ground water infiltration (as defined at 40 CFR 35.2005(20));
  - Uncontaminated pumped ground water;
  - Foundation drains;
  - Springs;
  - Water from crawl space pumps;
  - Footing drains;
  - Air conditioning condensation;
  - Flows from riparian habitats and wetlands;
  - Water line and hydrant flushing ;
  - Landscape irrigation;
  - Planned and unplanned discharges from potable water sources;
  - Irrigation water;
  - Individual residential car washing; and
  - Lawn watering.

Municipal facilities subject to industrial general permit requirements must include a certification that the stormwater collection system has been tested or evaluated for the presence



of non-stormwater discharges. The state's General Industrial Stormwater Permit requires that non-stormwater discharges be eliminated prior to implementation of the facility's SWPPP.

#### *Storm Drain Stenciling*

- Stencil storm drain inlets with a message to prohibit illegal dumpings, especially in areas with waste handling facilities.
- Encourage public reporting of improper waste disposal by a HOTLINE number stenciled onto the storm drain inlet.
- See Supplemental Information section of this fact sheet for further detail on stenciling program approach.

#### *Oil Recycling*

- Contract collection and hauling of used oil to a private licensed used oil hauler/recycler.
- Comply with all applicable state and federal regulations regarding storage, handling, and transport of petroleum products.
- Create procedures for collection such as; collection locations and schedule, acceptable containers, and maximum amounts accepted.
- The California Integrated Waste Management Board has a Recycling Hotline, (800) 553-2962, that provides information and recycling locations for used oil.

#### ***Household Hazardous Waste***

- Provide household hazardous waste (HHW) collection facilities. Several types of collection approaches are available including permanent, periodic, or mobile centers, curbside collection, or a combination of these systems.

#### ***Training***

- Train municipal employees and contractors in proper and consistent methods for waste disposal.
- Train municipal employees to recognize and report illegal dumping.
- Train employees and subcontractors in proper hazardous waste management.

#### ***Spill Response and Prevention***

- Refer to SC-11, Spill Prevention, Control & Cleanup
- Have spill cleanup materials readily available and in a known location.
- Cleanup spills immediately and use dry methods if possible.
- Properly dispose of spill cleanup material.

## ***Other Considerations***

- Federal Regulations (RCRA, SARA, CERCLA) and state regulations exist regarding the disposal of hazardous waste.
- Municipalities are required to have a used oil recycling element and a HHW element within their integrated waste management plan.
- Significant liability issues are involved with the collection, handling, and disposal of HHW.

## ***Examples***

The City of Palo Alto has developed a public participation program for reporting dumping violations. When a concerned citizen or public employee encounters evidence of illegal dumping, a door hanger (similar in format to hotel "Do Not Disturb" signs) is placed on the front doors in the neighborhood. The door hanger notes that a violation has occurred in the neighborhood, informs the reader why illegal dumping is a problem, and notes that illegal dumping carries a significant financial penalty. Information is also provided on what citizens can do as well as contact numbers for more information or to report a violation.

The Port of Long Beach has a state of the art database incorporating storm drain infrastructure, potential pollutant sources, facility management practices, and a pollutant tracking system.

The State Department of Fish and Game has a hotline for reporting violations called CalTIP (1-800-952-5400). The phone number may be used to report any violation of a Fish and Game code (illegal dumping, poaching, etc.).

The California Department of Toxic Substances Control's Waste Alert Hotline, 1-800-69TOXIC, can be used to report hazardous waste violations.

## **References and Resources**

<http://www.stormwatercenter.net/>

California's Nonpoint Source Program Plan <http://www.co.clark.wa.us/pubworks/bmpman.pdf>

King County Stormwater Pollution Control Manual - <http://dnr.metrokc.gov/wlr/dss/spcm.htm>

Orange County Stormwater Program,  
[http://www.ocwatersheds.com/stormwater/swp\\_introduction.asp](http://www.ocwatersheds.com/stormwater/swp_introduction.asp)

San Diego Stormwater Co-permittees Jurisdictional Urban Runoff Management Program  
(<http://www.projectcleanwater.org>)

Santa Clara Valley Urban Runoff Pollution Prevention Program  
[http://www.scvurppp-w2k.com/pdf%20documents/PS\\_ICID.PDF](http://www.scvurppp-w2k.com/pdf%20documents/PS_ICID.PDF)

# Spill Prevention, Control & Cleanup SC-11



Photo Credit: Geoff Brosseau

## Objectives

- Cover
- Contain
- Educate
- Reduce/Minimize
- Product Substitution

## Description

Many activities that occur at an industrial or commercial site have the potential to cause accidental or illegal spills. Preparation for accidental or illegal spills, with proper training and reporting systems implemented, can minimize the discharge of pollutants to the environment.

Spills and leaks are one of the largest contributors of stormwater pollutants. Spill prevention and control plans are applicable to any site at which hazardous materials are stored or used. An effective plan should have spill prevention and response procedures that identify potential spill areas, specify material handling procedures, describe spill response procedures, and provide spill clean-up equipment. The plan should take steps to identify and characterize potential spills, eliminate and reduce spill potential, respond to spills when they occur in an effort to prevent pollutants from entering the stormwater drainage system, and train personnel to prevent and control future spills.

## Approach

### *Pollution Prevention*

- Develop procedures to prevent/mitigate spills to storm drain systems. Develop and standardize reporting procedures, containment, storage, and disposal activities, documentation, and follow-up procedures.
- Develop a Spill Prevention Control and Countermeasure (SPCC) Plan. The plan should include:

## Targeted Constituents

Sediment	
Nutrients	
Trash	
Metals	<input checked="" type="checkbox"/>
Bacteria	
Oil and Grease	<input checked="" type="checkbox"/>
Organics	<input checked="" type="checkbox"/>



# **SC-11 Spill Prevention, Control & Cleanup**

---

- Description of the facility, owner and address, activities and chemicals present
- Facility map
- Notification and evacuation procedures
- Cleanup instructions
- Identification of responsible departments
- Identify key spill response personnel
- Recycle, reclaim, or reuse materials whenever possible. This will reduce the amount of process materials that are brought into the facility.

## ***Suggested Protocols (including equipment needs)***

### ***Spill Prevention***

- Develop procedures to prevent/mitigate spills to storm drain systems. Develop and standardize reporting procedures, containment, storage, and disposal activities, documentation, and follow-up procedures.
- If consistent illegal dumping is observed at the facility:
  - Post “No Dumping” signs with a phone number for reporting illegal dumping and disposal. Signs should also indicate fines and penalties applicable for illegal dumping.
  - Landscaping and beautification efforts may also discourage illegal dumping.
  - Bright lighting and/or entrance barriers may also be needed to discourage illegal dumping.
- Store and contain liquid materials in such a manner that if the tank is ruptured, the contents will not discharge, flow, or be washed into the storm drainage system, surface waters, or groundwater.
- If the liquid is oil, gas, or other material that separates from and floats on water, install a spill control device (such as a tee section) in the catch basins that collects runoff from the storage tank area.
- Routine maintenance:
  - Place drip pans or absorbent materials beneath all mounted taps, and at all potential drip and spill locations during filling and unloading of tanks. Any collected liquids or soiled absorbent materials must be reused/recycled or properly disposed.
  - Store and maintain appropriate spill cleanup materials in a location known to all near the tank storage area; and ensure that employees are familiar with the site’s spill control plan and/or proper spill cleanup procedures.
  - Sweep and clean the storage area monthly if it is paved, *do not hose down the area to a storm drain.*



# Spill Prevention, Control & Cleanup SC-11

---

- Check tanks (and any containment sumps) daily for leaks and spills. Replace tanks that are leaking, corroded, or otherwise deteriorating with tanks in good condition. Collect all spilled liquids and properly dispose of them.
- Label all containers according to their contents (e.g., solvent, gasoline).
- Label hazardous substances regarding the potential hazard (corrosive, radioactive, flammable, explosive, poisonous).
- Prominently display required labels on transported hazardous and toxic materials (per US DOT regulations).
- Identify key spill response personnel.

## *Spill Control and Cleanup Activities*

- Follow the Spill Prevention Control and Countermeasure Plan.
- Clean up leaks and spills immediately.
- Place a stockpile of spill cleanup materials where it will be readily accessible (e.g., near storage and maintenance areas).
- On paved surfaces, clean up spills with as little water as possible. Use a rag for small spills, a damp mop for general cleanup, and absorbent material for larger spills. If the spilled material is hazardous, then the used cleanup materials are also hazardous and must be sent to a certified laundry (rags) or disposed of as hazardous waste. Physical methods for the cleanup of dry chemicals include the use of brooms, shovels, sweepers, or plows.
- Never hose down or bury dry material spills. Sweep up the material and dispose of properly.
- Chemical cleanups of material can be achieved with the use of adsorbents, gels, and foams. Use adsorbent materials on small spills rather than hosing down the spill. Remove the adsorbent materials promptly and dispose of properly.
- For larger spills, a private spill cleanup company or Hazmat team may be necessary.

## *Reporting*

- Report spills that pose an immediate threat to human health or the environment to the Regional Water Quality Control Board.
- Federal regulations require that any oil spill into a water body or onto an adjoining shoreline be reported to the National Response Center (NRC) at 800-424-8802 (24 hour).
- Report spills to local agencies, such as the fire department; they can assist in cleanup.
- Establish a system for tracking incidents. The system should be designed to identify the following:
  - Types and quantities (in some cases) of wastes
  - Patterns in time of occurrence (time of day/night, month, or year)

# **SC-11 Spill Prevention, Control & Cleanup**

---

- Mode of dumping (abandoned containers, “midnight dumping” from moving vehicles, direct dumping of materials, accidents/spills)
- Responsible parties

## ***Training***

- Educate employees about spill prevention and cleanup.
- Well-trained employees can reduce human errors that lead to accidental releases or spills:
  - The employee should have the tools and knowledge to immediately begin cleaning up a spill should one occur.
  - Employees should be familiar with the Spill Prevention Control and Countermeasure Plan.
- Employees should be educated about aboveground storage tank requirements. Employees responsible for aboveground storage tanks and liquid transfers should be thoroughly familiar with the Spill Prevention Control and Countermeasure Plan and the plan should be readily available.
- Train employees to recognize and report illegal dumping incidents.

## ***Other Considerations (Limitations and Regulations)***

- A Spill Prevention Control and Countermeasure Plan (SPCC) is required for facilities that are subject to the oil pollution regulations specified in Part 112 of Title 40 of the Code of Federal Regulations or if they have a storage capacity of 10,000 gallons or more of petroleum. (Health and Safety Code 6.67)
- State regulations also exist for storage of hazardous materials (Health & Safety Code Chapter 6.95), including the preparation of area and business plans for emergency response to the releases or threatened releases.
- Consider requiring smaller secondary containment areas (less than 200 sq. ft.) to be connected to the sanitary sewer, prohibiting any hard connections to the storm drain.

## **Requirements**

### ***Costs (including capital and operation & maintenance)***

- Will vary depending on the size of the facility and the necessary controls.
- Prevention of leaks and spills is inexpensive. Treatment and/or disposal of contaminated soil or water can be quite expensive.

### ***Maintenance (including administrative and staffing)***

- This BMP has no major administrative or staffing requirements. However, extra time is needed to properly handle and dispose of spills, which results in increased labor costs.

# **Spill Prevention, Control & Cleanup SC-11**

---

## **Supplemental Information**

### ***Further Detail of the BMP***

#### *Reporting*

Record keeping and internal reporting represent good operating practices because they can increase the efficiency of the facility and the effectiveness of BMPs. A good record keeping system helps the facility minimize incident recurrence, correctly respond with appropriate cleanup activities, and comply with legal requirements. A record keeping and reporting system should be set up for documenting spills, leaks, and other discharges, including discharges of hazardous substances in reportable quantities. Incident records describe the quality and quantity of non-stormwater discharges to the storm sewer. These records should contain the following information:

- Date and time of the incident
- Weather conditions
- Duration of the spill/leak/discharge
- Cause of the spill/leak/discharge
- Response procedures implemented
- Persons notified
- Environmental problems associated with the spill/leak/discharge

Separate record keeping systems should be established to document housekeeping and preventive maintenance inspections, and training activities. All housekeeping and preventive maintenance inspections should be documented. Inspection documentation should contain the following information:

- The date and time the inspection was performed
- Name of the inspector
- Items inspected
- Problems noted
- Corrective action required
- Date corrective action was taken

Other means to document and record inspection results are field notes, timed and dated photographs, videotapes, and drawings and maps.

#### *Aboveground Tank Leak and Spill Control*

Accidental releases of materials from aboveground liquid storage tanks present the potential for contaminating stormwater with many different pollutants. Materials spilled, leaked, or lost from

# **SC-11 Spill Prevention, Control & Cleanup**

tanks may accumulate in soils or on impervious surfaces and be carried away by stormwater runoff.

The most common causes of unintentional releases are:

- Installation problems
- Failure of piping systems (pipes, pumps, flanges, couplings, hoses, and valves)
- External corrosion and structural failure
- Spills and overfills due to operator error
- Leaks during pumping of liquids or gases from truck or rail car to a storage tank or vice versa

Storage of reactive, ignitable, or flammable liquids should comply with the Uniform Fire Code and the National Electric Code. Practices listed below should be employed to enhance the code requirements:

- Tanks should be placed in a designated area.
- Tanks located in areas where firearms are discharged should be encapsulated in concrete or the equivalent.
- Designated areas should be impervious and paved with Portland cement concrete, free of cracks and gaps, in order to contain leaks and spills.
- Liquid materials should be stored in UL approved double walled tanks or surrounded by a curb or dike to provide the volume to contain 10 percent of the volume of all of the containers or 110 percent of the volume of the largest container, whichever is greater. The area inside the curb should slope to a drain.
- For used oil or dangerous waste, a dead-end sump should be installed in the drain.
- All other liquids should be drained to the sanitary sewer if available. The drain must have a positive control such as a lock, valve, or plug to prevent release of contaminated liquids.
- Accumulated stormwater in petroleum storage areas should be passed through an oil/water separator.

Maintenance is critical to preventing leaks and spills. Conduct routine inspections and:

- Check for external corrosion and structural failure.
- Check for spills and overfills due to operator error.
- Check for failure of piping system (pipes, pumps, flanger, coupling, hoses, and valves).
- Check for leaks or spills during pumping of liquids or gases from truck or rail car to a storage facility or vice versa.



# **Spill Prevention, Control & Cleanup SC-11**

---

- Visually inspect new tank or container installation for loose fittings, poor welding, and improper or poorly fitted gaskets.
- Inspect tank foundations, connections, coatings, and tank walls and piping system. Look for corrosion, leaks, cracks, scratches, and other physical damage that may weaken the tank or container system.
- Frequently relocate accumulated stormwater during the wet season.
- Periodically conduct integrity testing by a qualified professional.

## *Vehicle Leak and Spill Control*

Major spills on roadways and other public areas are generally handled by highly trained Hazmat teams from local fire departments or environmental health departments. The measures listed below pertain to leaks and smaller spills at vehicle maintenance shops.

In addition to implementing the spill prevention, control, and clean up practices above, use the following measures related to specific activities:

## *Vehicle and Equipment Maintenance*

- Perform all vehicle fluid removal or changing inside or under cover to prevent the run-on of stormwater and the runoff of spills.
- Regularly inspect vehicles and equipment for leaks, and repair immediately.
- Check incoming vehicles and equipment (including delivery trucks, and employee and subcontractor vehicles) for leaking oil and fluids. Do not allow leaking vehicles or equipment onsite.
- Always use secondary containment, such as a drain pan or drop cloth, to catch spills or leaks when removing or changing fluids.
- Immediately drain all fluids from wrecked vehicles.
- Store wrecked vehicles or damaged equipment under cover.
- Place drip pans or absorbent materials under heavy equipment when not in use.
- Use adsorbent materials on small spills rather than hosing down the spill.
- Remove the adsorbent materials promptly and dispose of properly.
- Promptly transfer used fluids to the proper waste or recycling drums. Don't leave full drip pans or other open containers lying around.
- Oil filters disposed of in trashcans or dumpsters can leak oil and contaminate stormwater. Place the oil filter in a funnel over a waste oil recycling drum to drain excess oil before disposal. Oil filters can also be recycled. Ask your oil supplier or recycler about recycling oil filters.

# **SC-11 Spill Prevention, Control & Cleanup**

---

- Store cracked batteries in a non-leaking secondary container. Do this with all cracked batteries, even if you think all the acid has drained out. If you drop a battery, treat it as if it is cracked. Put it into the containment area until you are sure it is not leaking.

## *Vehicle and Equipment Fueling*

- Design the fueling area to prevent the run-on of stormwater and the runoff of spills:
  - Cover fueling area if possible.
  - Use a perimeter drain or slope pavement inward with drainage to a sump.
  - Pave fueling area with concrete rather than asphalt.
- If dead-end sump is not used to collect spills, install an oil/water separator.
- Install vapor recovery nozzles to help control drips as well as air pollution.
- Discourage “topping-off” of fuel tanks.
- Use secondary containment when transferring fuel from the tank truck to the fuel tank.
- Use adsorbent materials on small spills and general cleaning rather than hosing down the area. Remove the adsorbent materials promptly.
- Carry out all Federal and State requirements regarding underground storage tanks, or install above ground tanks.
- Do not use mobile fueling of mobile industrial equipment around the facility; rather, transport the equipment to designated fueling areas.
- Keep your Spill Prevention Control and Countermeasure (SPCC) Plan up-to-date.
- Train employees in proper fueling and cleanup procedures.

## *Industrial Spill Prevention Response*

For the purposes of developing a spill prevention and response program to meet the stormwater regulations, facility managers should use information provided in this fact sheet and the spill prevention/response portions of the fact sheets in this handbook, for specific activities. The program should:

- Integrate with existing emergency response/hazardous materials programs (e.g., Fire Department)
- Develop procedures to prevent/mitigate spills to storm drain systems
- Identify responsible departments
- Develop and standardize reporting procedures, containment, storage, and disposal activities, documentation, and follow-up procedures
- Address spills at municipal facilities, as well as public areas

# **Spill Prevention, Control & Cleanup SC-11**

---

- Provide training concerning spill prevention, response and cleanup to all appropriate personnel

## **References and Resources**

California's Nonpoint Source Program Plan <http://www.swrcb.ca.gov/nps/index.html>

Clark County Storm Water Pollution Control Manual  
<http://www.co.clark.wa.us/pubworks/bmpman.pdf>

King County Storm Water Pollution Control Manual <http://dnr.metrokc.gov/wlr/dss/spcm.htm>

Santa Clara Valley Urban Runoff Pollution Prevention Program <http://www.scvurppp.org>

The Stormwater Managers Resource Center <http://www.stormwatercenter.net/>



## Description

As a consequence of its function, the stormwater conveyance system collects and transports urban runoff and stormwater that may contain certain pollutants. The protocols in this fact sheet are intended to reduce pollutants reaching receiving waters through proper conveyance system operation and maintenance.

## Approach

### *Pollution Prevention*

Maintain catch basins, stormwater inlets, and other stormwater conveyance structures on a regular basis to remove pollutants, reduce high pollutant concentrations during the first flush of storms, prevent clogging of the downstream conveyance system, restore catch basins' sediment trapping capacity, and ensure the system functions properly hydraulically to avoid flooding.

### *Suggested Protocols*

#### *Catch Basins/Inlet Structures*

- Staff should regularly inspect facilities to ensure compliance with the following:
  - Immediate repair of any deterioration threatening structural integrity.
  - Cleaning before the sump is 40% full. Catch basins should be cleaned as frequently as needed to meet this standard.
  - Stenciling of catch basins and inlets (see SC34 Waste Handling and Disposal).

## Objectives

- Cover
- Contain
- Educate
- Reduce/Minimize

## Targeted Constituents

Sediment	✓
Nutrients	
Trash	✓
Metals	
Bacteria	✓
Oil and Grease	
Organics	





# SC-44      Drainage System Maintenance

---

- Clean catch basins, storm drain inlets, and other conveyance structures before the wet season to remove sediments and debris accumulated during the summer.
- Conduct inspections more frequently during the wet season for problem areas where sediment or trash accumulates more often. Clean and repair as needed.
- Keep accurate logs of the number of catch basins cleaned.
- Store wastes collected from cleaning activities of the drainage system in appropriate containers or temporary storage sites in a manner that prevents discharge to the storm drain.
- Dewater the wastes if necessary with outflow into the sanitary sewer if permitted. Water should be treated with an appropriate filtering device prior to discharge to the sanitary sewer. If discharge to the sanitary sewer is not allowed, water should be pumped or vacuumed to a tank and properly disposed. Do not dewater near a storm drain or stream.

## *Storm Drain Conveyance System*

- Locate reaches of storm drain with deposit problems and develop a flushing schedule that keeps the pipe clear of excessive buildup.
- Collect and pump flushed effluent to the sanitary sewer for treatment whenever possible.

## *Pump Stations*

- Clean all storm drain pump stations prior to the wet season to remove silt and trash.
- Do not allow discharge to reach the storm drain system when cleaning a storm drain pump station or other facility.
- Conduct routine maintenance at each pump station.
- Inspect, clean, and repair as necessary all outlet structures prior to the wet season.

## *Open Channel*

- Modify storm channel characteristics to improve channel hydraulics, increase pollutant removals, and enhance channel/creek aesthetic and habitat value.
- Conduct channel modification/improvement in accordance with existing laws. Any person, government agency, or public utility proposing an activity that will change the natural (emphasis added) state of any river, stream, or lake in California, must enter into a Stream or Lake Alteration Agreement with the Department of Fish and Game. The developer-applicant should also contact local governments (city, county, special districts), other state agencies (SWRCB, RWQCB, Department of Forestry, Department of Water Resources), and Federal Corps of Engineers and USFWS.

## *Illicit Connections and Discharges*

- Look for evidence of illegal discharges or illicit connections during routine maintenance of conveyance system and drainage structures:
  - Is there evidence of spills such as paints, discoloring, etc?

- Are there any odors associated with the drainage system?
- Record locations of apparent illegal discharges/illicit connections?
- Track flows back to potential dischargers and conduct aboveground inspections. This can be done through visual inspection of upgradient manholes or alternate techniques including zinc chloride smoke testing, fluorometric dye testing, physical inspection testing, or television camera inspection.
- Eliminate the discharge once the origin of flow is established.
- Stencil or demarcate storm drains, where applicable, to prevent illegal disposal of pollutants. Storm drain inlets should have messages such as “Dump No Waste Drains to Stream” stenciled next to them to warn against ignorant or intentional dumping of pollutants into the storm drainage system.
- Refer to fact sheet SC-10 Non-Stormwater Discharges.

### *Illegal Dumping*

- Inspect and clean up hot spots and other storm drainage areas regularly where illegal dumping and disposal occurs.
- Establish a system for tracking incidents. The system should be designed to identify the following:
  - Illegal dumping hot spots
  - Types and quantities (in some cases) of wastes
  - Patterns in time of occurrence (time of day/night, month, or year)
  - Mode of dumping (abandoned containers, “midnight dumping” from moving vehicles, direct dumping of materials, accidents/spills)
  - Responsible parties
- Post “No Dumping” signs in problem areas with a phone number for reporting dumping and disposal. Signs should also indicate fines and penalties for illegal dumping.
- Refer to fact sheet SC-10 Non-Stormwater Discharges.

### *Training*

- Train crews in proper maintenance activities, including record keeping and disposal.
- Allow only properly trained individuals to handle hazardous materials/wastes.
- Have staff involved in detection and removal of illicit connections trained in the following:
  - OSHA-required Health and Safety Training (29 CFR 1910.120) plus annual refresher training (as needed).

# SC-44      Drainage System Maintenance

---

- OSHA Confined Space Entry training (Cal-OSHA Confined Space, Title 8 and Federal OSHA 29 CFR 1910.146).
- Procedural training (field screening, sampling, smoke/dye testing, TV inspection).

## ***Spill Response and Prevention***

- Investigate all reports of spills, leaks, and/or illegal dumping promptly.
- Clean up all spills and leaks using “dry” methods (with absorbent materials and/or rags) or dig up, remove, and properly dispose of contaminated soil.
- Refer to fact sheet SC-11 Spill Prevention, Control, and Cleanup.

## ***Other Considerations (Limitations and Regulations)***

- Clean-up activities may create a slight disturbance for local aquatic species. Access to items and material on private property may be limited. Trade-offs may exist between channel hydraulics and water quality/riparian habitat. If storm channels or basins are recognized as wetlands, many activities, including maintenance, may be subject to regulation and permitting.
- Storm drain flushing is most effective in small diameter pipes (36-inch diameter pipe or less, depending on water supply and sediment collection capacity). Other considerations associated with storm drain flushing may include the availability of a water source, finding a downstream area to collect sediments, liquid/sediment disposal, and prohibition against disposal of flushed effluent to sanitary sewer in some areas.
- Regulations may include adoption of substantial penalties for illegal dumping and disposal.
- Local municipal codes may include sections prohibiting discharge of soil, debris, refuse, hazardous wastes, and other pollutants into the storm drain system.

## **Requirements**

### ***Costs***

- An aggressive catch basin cleaning program could require a significant capital and O&M budget.
- The elimination of illegal dumping is dependent on the availability, convenience, and cost of alternative means of disposal. The primary cost is for staff time. Cost depends on how aggressively a program is implemented. Other cost considerations for an illegal dumping program include:
  - Purchase and installation of signs.
  - Rental of vehicle(s) to haul illegally-disposed items and material to landfills.
  - Rental of heavy equipment to remove larger items (e.g., car bodies) from channels.
  - Purchase of landfill space to dispose of illegally-dumped items and material.

- Methods used for illicit connection detection (smoke testing, dye testing, visual inspection, and flow monitoring) can be costly and time-consuming. Site-specific factors, such as the level of impervious area, the density and ages of buildings, and type of land use will determine the level of investigation necessary.

## ***Maintenance***

- Two-person teams may be required to clean catch basins with vacuum trucks.
- Teams of at least two people plus administrative personnel are required to identify illicit discharges, depending on the complexity of the storm sewer system.
- Arrangements must be made for proper disposal of collected wastes.
- Technical staff are required to detect and investigate illegal dumping violations.

## **Supplemental Information**

### ***Further Detail of the BMP***

#### ***Storm Drain Flushing***

Flushing is a common maintenance activity used to improve pipe hydraulics and to remove pollutants in storm drainage systems. Flushing may be designed to hydraulically convey accumulated material to strategic locations, such as an open channel, another point where flushing will be initiated, or the sanitary sewer and the treatment facilities, thus preventing resuspension and overflow of a portion of the solids during storm events. Flushing prevents “plug flow” discharges of concentrated pollutant loadings and sediments. Deposits can hinder the designed conveyance capacity of the storm drain system and potentially cause backwater conditions in severe cases of clogging.

Storm drain flushing usually takes place along segments of pipe with grades that are too flat to maintain adequate velocity to keep particles in suspension. An upstream manhole is selected to place an inflatable device that temporarily plugs the pipe. Further upstream, water is pumped into the line to create a flushing wave. When the upstream reach of pipe is sufficiently full to cause a flushing wave, the inflated device is rapidly deflated with the assistance of a vacuum pump, thereby releasing the backed up water and resulting in the cleaning of the storm drain segment.

To further reduce impacts of stormwater pollution, a second inflatable device placed well downstream may be used to recollect the water after the force of the flushing wave has dissipated. A pump may then be used to transfer the water and accumulated material to the sanitary sewer for treatment. In some cases, an interceptor structure may be more practical or required to recollect the flushed waters.

It has been found that cleansing efficiency of periodic flush waves is dependent upon flush volume, flush discharge rate, sewer slope, sewer length, sewer flow rate, sewer diameter, and population density. As a rule of thumb, the length of line to be flushed should not exceed 700 feet. At this maximum recommended length, the percent removal efficiency ranges between 65-75% for organics and 55-65% for dry weather grit/inorganic material. The percent removal efficiency drops rapidly beyond that. Water is commonly supplied by a water truck, but fire hydrants can also supply water. To make the best use of water, it is recommended that reclaimed water be used or that fire hydrant line flushing coincide with storm sewer flushing.



# SC-44      Drainage System Maintenance

---

## References and Resources

California's Nonpoint Source Program Plan <http://www.swrcb.ca.gov/nps/index.html>

Clark County Storm Water Pollution Control Manual  
<http://www.co.clark.wa.us/pubworks/bmpman.pdf>

Ferguson, B.K. 1991. Urban Stream Reclamation, p. 324-322, Journal of Soil and Water Conservation.

King County Storm Water Pollution Control Manual <http://dnr.metrokc.gov/wlr/dss/spcm.htm>

Oregon Association of Clean Water Agencies. Oregon Municipal Stormwater Toolbox for Maintenance Practices. June 1998.

Santa Clara Valley Urban Runoff Pollution Prevention Program <http://www.scvurppp.org>

The Storm Water Managers Resource Center <http://www.stormwatercenter.net>

United States Environmental Protection Agency (USEPA). 2002. Pollution Prevention/Good Housekeeping for Municipal Operations Storm Drain System Cleaning. On line:  
[http://www.epa.gov/npdes/menuofbmps/poll\\_16.htm](http://www.epa.gov/npdes/menuofbmps/poll_16.htm)

# Site Design & Landscape Planning SD-10



## Design Objectives

- Maximize Infiltration
- Provide Retention
- Slow Runoff
- Minimize Impervious Land Coverage
- Prohibit Dumping of Improper Materials
- Contain Pollutants
- Collect and Convey

## Description

Each project site possesses unique topographic, hydrologic, and vegetative features, some of which are more suitable for development than others. Integrating and incorporating appropriate landscape planning methodologies into the project design is the most effective action that can be done to minimize surface and groundwater contamination from stormwater.

## Approach

Landscape planning should couple consideration of land suitability for urban uses with consideration of community goals and projected growth. Project plan designs should conserve natural areas to the extent possible, maximize natural water storage and infiltration opportunities, and protect slopes and channels.

## Suitable Applications

Appropriate applications include residential, commercial and industrial areas planned for development or redevelopment.

## Design Considerations

Design requirements for site design and landscapes planning should conform to applicable standards and specifications of agencies with jurisdiction and be consistent with applicable General Plan and Local Area Plan policies.



# **SD-10 Site Design & Landscape Planning**

---

## ***Designing New Installations***

Begin the development of a plan for the landscape unit with attention to the following general principles:

- Formulate the plan on the basis of clearly articulated community goals. Carefully identify conflicts and choices between retaining and protecting desired resources and community growth.
- Map and assess land suitability for urban uses. Include the following landscape features in the assessment: wooded land, open unwooded land, steep slopes, erosion-prone soils, foundation suitability, soil suitability for waste disposal, aquifers, aquifer recharge areas, wetlands, floodplains, surface waters, agricultural lands, and various categories of urban land use. When appropriate, the assessment can highlight outstanding local or regional resources that the community determines should be protected (e.g., a scenic area, recreational area, threatened species habitat, farmland, fish run). Mapping and assessment should recognize not only these resources but also additional areas needed for their sustenance.

Project plan designs should conserve natural areas to the extent possible, maximize natural water storage and infiltration opportunities, and protect slopes and channels.

## ***Conserve Natural Areas during Landscape Planning***

If applicable, the following items are required and must be implemented in the site layout during the subdivision design and approval process, consistent with applicable General Plan and Local Area Plan policies:

- Cluster development on least-sensitive portions of a site while leaving the remaining land in a natural undisturbed condition.
- Limit clearing and grading of native vegetation at a site to the minimum amount needed to build lots, allow access, and provide fire protection.
- Maximize trees and other vegetation at each site by planting additional vegetation, clustering tree areas, and promoting the use of native and/or drought tolerant plants.
- Promote natural vegetation by using parking lot islands and other landscaped areas.
- Preserve riparian areas and wetlands.

## ***Maximize Natural Water Storage and Infiltration Opportunities Within the Landscape Unit***

- Promote the conservation of forest cover. Building on land that is already deforested affects basin hydrology to a lesser extent than converting forested land. Loss of forest cover reduces interception storage, detention in the organic forest floor layer, and water losses by evapotranspiration, resulting in large peak runoff increases and either their negative effects or the expense of countering them with structural solutions.
- Maintain natural storage reservoirs and drainage corridors, including depressions, areas of permeable soils, swales, and intermittent streams. Develop and implement policies and

# Site Design & Landscape Planning SD-10

---

regulations to discourage the clearing, filling, and channelization of these features. Utilize them in drainage networks in preference to pipes, culverts, and engineered ditches.

- Evaluating infiltration opportunities by referring to the stormwater management manual for the jurisdiction and pay particular attention to the selection criteria for avoiding groundwater contamination, poor soils, and hydrogeological conditions that cause these facilities to fail. If necessary, locate developments with large amounts of impervious surfaces or a potential to produce relatively contaminated runoff away from groundwater recharge areas.

## *Protection of Slopes and Channels during Landscape Design*

- Convey runoff safely from the tops of slopes.
- Avoid disturbing steep or unstable slopes.
- Avoid disturbing natural channels.
- Stabilize disturbed slopes as quickly as possible.
- Vegetate slopes with native or drought tolerant vegetation.
- Control and treat flows in landscaping and/or other controls prior to reaching existing natural drainage systems.
- Stabilize temporary and permanent channel crossings as quickly as possible, and ensure that increases in run-off velocity and frequency caused by the project do not erode the channel.
- Install energy dissipaters, such as riprap, at the outlets of new storm drains, culverts, conduits, or channels that enter unlined channels in accordance with applicable specifications to minimize erosion. Energy dissipaters shall be installed in such a way as to minimize impacts to receiving waters.
- Line on-site conveyance channels where appropriate, to reduce erosion caused by increased flow velocity due to increases in tributary impervious area. The first choice for linings should be grass or some other vegetative surface, since these materials not only reduce runoff velocities, but also provide water quality benefits from filtration and infiltration. If velocities in the channel are high enough to erode grass or other vegetative linings, riprap, concrete, soil cement, or geo-grid stabilization are other alternatives.
- Consider other design principles that are comparable and equally effective.

## ***Redeveloping Existing Installations***

Various jurisdictional stormwater management and mitigation plans (SUSMP, WQMP, etc.) define “redevelopment” in terms of amounts of additional impervious area, increases in gross floor area and/or exterior construction, and land disturbing activities with structural or impervious surfaces. The definition of “redevelopment” must be consulted to determine whether or not the requirements for new development apply to areas intended for redevelopment. If the definition applies, the steps outlined under “designing new installations” above should be followed.



# **SD-10 Site Design & Landscape Planning**

Redevelopment may present significant opportunity to add features which had not previously been implemented. Examples include incorporation of depressions, areas of permeable soils, and swales in newly redeveloped areas. While some site constraints may exist due to the status of already existing infrastructure, opportunities should not be missed to maximize infiltration, slow runoff, reduce impervious areas, disconnect directly connected impervious areas.

## **Other Resources**

A Manual for the Standard Urban Stormwater Mitigation Plan (SUSMP), Los Angeles County Department of Public Works, May 2002.

Stormwater Management Manual for Western Washington, Washington State Department of Ecology, August 2001.

Model Standard Urban Storm Water Mitigation Plan (SUSMP) for San Diego County, Port of San Diego, and Cities in San Diego County, February 14, 2002.

Model Water Quality Management Plan (WQMP) for County of Orange, Orange County Flood Control District, and the Incorporated Cities of Orange County, Draft February 2003.

Ventura Countywide Technical Guidance Manual for Stormwater Quality Control Measures, July 2002.



Rain Garden

## Design Objectives

- Maximize Infiltration
- Provide Retention
- Slow Runoff
- Minimize Impervious Land Coverage
- Prohibit Dumping of Improper Materials
- Contain Pollutants
- Collect and Convey

## Description

Various roof runoff controls are available to address stormwater that drains off rooftops. The objective is to reduce the total volume and rate of runoff from individual lots, and retain the pollutants on site that may be picked up from roofing materials and atmospheric deposition. Roof runoff controls consist of directing the roof runoff away from paved areas and mitigating flow to the storm drain system through one of several general approaches: cisterns or rain barrels; dry wells or infiltration trenches; pop-up emitters, and foundation planting. The first three approaches require the roof runoff to be contained in a gutter and downspout system. Foundation planting provides a vegetated strip under the drip line of the roof.

## Approach

Design of individual lots for single-family homes as well as lots for higher density residential and commercial structures should consider site design provisions for containing and infiltrating roof runoff or directing roof runoff to vegetative swales or buffer areas. Retained water can be reused for watering gardens, lawns, and trees. Benefits to the environment include reduced demand for potable water used for irrigation, improved stormwater quality, increased groundwater recharge, decreased runoff volume and peak flows, and decreased flooding potential.

## Suitable Applications

Appropriate applications include residential, commercial and industrial areas planned for development or redevelopment.

## Design Considerations

### *Designing New Installations*

#### *Cisterns or Rain Barrels*

One method of addressing roof runoff is to direct roof downspouts to cisterns or rain barrels. A cistern is an above ground storage vessel with either a manually operated valve or a permanently open outlet. Roof runoff is temporarily stored and then released for irrigation or infiltration between storms. The number of rain



barrels needed is a function of the rooftop area. Some low impact developers recommend that every house have at least 2 rain barrels, with a minimum storage capacity of 1000 liters. Roof barrels serve several purposes including mitigating the first flush from the roof which has a high volume, amount of contaminants, and thermal load. Several types of rain barrels are commercially available. Consideration must be given to selecting rain barrels that are vector proof and childproof. In addition, some barrels are designed with a bypass valve that filters out grit and other contaminants and routes overflow to a soak-away pit or rain garden.

If the cistern has an operable valve, the valve can be closed to store stormwater for irrigation or infiltration between storms. This system requires continual monitoring by the resident or grounds crews, but provides greater flexibility in water storage and metering. If a cistern is provided with an operable valve and water is stored inside for long periods, the cistern must be covered to prevent mosquitoes from breeding.

A cistern system with a permanently open outlet can also provide for metering stormwater runoff. If the cistern outlet is significantly smaller than the size of the downspout inlet (say ¼ to ½ inch diameter), runoff will build up inside the cistern during storms, and will empty out slowly after peak intensities subside. This is a feasible way to mitigate the peak flow increases caused by rooftop impervious land coverage, especially for the frequent, small storms.

#### *Dry wells and Infiltration Trenches*

Roof downspouts can be directed to dry wells or infiltration trenches. A dry well is constructed by excavating a hole in the ground and filling it with an open graded aggregate, and allowing the water to fill the dry well and infiltrate after the storm event. An underground connection from the downspout conveys water into the dry well, allowing it to be stored in the voids. To minimize sedimentation from lateral soil movement, the sides and top of the stone storage matrix can be wrapped in a permeable filter fabric, though the bottom may remain open. A perforated observation pipe can be inserted vertically into the dry well to allow for inspection and maintenance.

In practice, dry wells receiving runoff from single roof downspouts have been successful over long periods because they contain very little sediment. They must be sized according to the amount of rooftop runoff received, but are typically 4 to 5 feet square, and 2 to 3 feet deep, with a minimum of 1-foot soil cover over the top (maximum depth of 10 feet).

To protect the foundation, dry wells must be set away from the building at least 10 feet. They must be installed in solids that accommodate infiltration. In poorly drained soils, dry wells have very limited feasibility.

Infiltration trenches function in a similar manner and would be particularly effective for larger roof areas. An infiltration trench is a long, narrow, rock-filled trench with no outlet that receives stormwater runoff. These are described under Treatment Controls.

#### *Pop-up Drainage Emitter*

Roof downspouts can be directed to an underground pipe that daylight some distance from the building foundation, releasing the roof runoff through a pop-up emitter. Similar to a pop-up irrigation head, the emitter only opens when there is flow from the roof. The emitter remains flush to the ground during dry periods, for ease of lawn or landscape maintenance.

## *Foundation Planting*

Landscape planting can be provided around the base to allow increased opportunities for stormwater infiltration and protect the soil from erosion caused by concentrated sheet flow coming off the roof. Foundation plantings can reduce the physical impact of water on the soil and provide a subsurface matrix of roots that encourage infiltration. These plantings must be sturdy enough to tolerate the heavy runoff sheet flows, and periodic soil saturation.

## ***Redeveloping Existing Installations***

Various jurisdictional stormwater management and mitigation plans (SUSMP, WQMP, etc.) define “redevelopment” in terms of amounts of additional impervious area, increases in gross floor area and/or exterior construction, and land disturbing activities with structural or impervious surfaces. The definition of “redevelopment” must be consulted to determine whether or not the requirements for new development apply to areas intended for redevelopment. If the definition applies, the steps outlined under “designing new installations” above should be followed.

## **Supplemental Information**

### ***Examples***

- City of Ottawa's Water Links Surface –Water Quality Protection Program
- City of Toronto Downspout Disconnection Program
- City of Boston, MA, Rain Barrel Demonstration Program

### **Other Resources**

Hager, Marty Catherine, Stormwater, “Low-Impact Development”, January/February 2003.  
[www.stormh2o.com](http://www.stormh2o.com)

Low Impact Urban Design Tools, Low Impact Development Design Center, Beltsville, MD.  
[www.lid-stormwater.net](http://www.lid-stormwater.net)

Start at the Source, Bay Area Stormwater Management Agencies Association, 1999 Edition





## Design Objectives

- Maximize Infiltration
- Provide Retention
- Slow Runoff
- Minimize Impervious Land Coverage
- Prohibit Dumping of Improper Materials
- Contain Pollutants
- Collect and Convey

## Description

Irrigation water provided to landscaped areas may result in excess irrigation water being conveyed into stormwater drainage systems.

## Approach

Project plan designs for development and redevelopment should include application methods of irrigation water that minimize runoff of excess irrigation water into the stormwater conveyance system.

## Suitable Applications

Appropriate applications include residential, commercial and industrial areas planned for development or redevelopment. (Detached residential single-family homes are typically excluded from this requirement.)

## Design Considerations

### *Designing New Installations*

The following methods to reduce excessive irrigation runoff should be considered, and incorporated and implemented where determined applicable and feasible by the Permittee:

- Employ rain-triggered shutoff devices to prevent irrigation after precipitation.
- Design irrigation systems to each landscape area's specific water requirements.
- Include design featuring flow reducers or shutoff valves triggered by a pressure drop to control water loss in the event of broken sprinkler heads or lines.
- Implement landscape plans consistent with County or City water conservation resolutions, which may include provision of water sensors, programmable irrigation times (for short cycles), etc.



- Design timing and application methods of irrigation water to minimize the runoff of excess irrigation water into the storm water drainage system.
- Group plants with similar water requirements in order to reduce excess irrigation runoff and promote surface filtration. Choose plants with low irrigation requirements (for example, native or drought tolerant species). Consider design features such as:
  - Using mulches (such as wood chips or bar) in planter areas without ground cover to minimize sediment in runoff
  - Installing appropriate plant materials for the location, in accordance with amount of sunlight and climate, and use native plant materials where possible and/or as recommended by the landscape architect
  - Leaving a vegetative barrier along the property boundary and interior watercourses, to act as a pollutant filter, where appropriate and feasible
  - Choosing plants that minimize or eliminate the use of fertilizer or pesticides to sustain growth
- Employ other comparable, equally effective methods to reduce irrigation water runoff.

***Redeveloping Existing Installations***

Various jurisdictional stormwater management and mitigation plans (SUSMP, WQMP, etc.) define “redevelopment” in terms of amounts of additional impervious area, increases in gross floor area and/or exterior construction, and land disturbing activities with structural or impervious surfaces. The definition of “redevelopment” must be consulted to determine whether or not the requirements for new development apply to areas intended for redevelopment. If the definition applies, the steps outlined under “designing new installations” above should be followed.

**Other Resources**

A Manual for the Standard Urban Stormwater Mitigation Plan (SUSMP), Los Angeles County Department of Public Works, May 2002.

Model Standard Urban Storm Water Mitigation Plan (SUSMP) for San Diego County, Port of San Diego, and Cities in San Diego County, February 14, 2002.

Model Water Quality Management Plan (WQMP) for County of Orange, Orange County Flood Control District, and the Incorporated Cities of Orange County, Draft February 2003.

Ventura Countywide Technical Guidance Manual for Stormwater Quality Control Measures, July 2002.



## Design Objectives

- Maximize Infiltration
- Provide Retention
- Slow Runoff
- Minimize Impervious Land Coverage
- Prohibit Dumping of Improper Materials
- Contain Pollutants
- Collect and Convey

## Description

Waste materials dumped into storm drain inlets can have severe impacts on receiving and ground waters. Posting notices regarding discharge prohibitions at storm drain inlets can prevent waste dumping. Storm drain signs and stencils are highly visible source controls that are typically placed directly adjacent to storm drain inlets.

## Approach

The stencil or affixed sign contains a brief statement that prohibits dumping of improper materials into the urban runoff conveyance system. Storm drain messages have become a popular method of alerting the public about the effects of and the prohibitions against waste disposal.

## Suitable Applications

Stencils and signs alert the public to the destination of pollutants discharged to the storm drain. Signs are appropriate in residential, commercial, and industrial areas, as well as any other area where contributions or dumping to storm drains is likely.

## Design Considerations

Storm drain message markers or placards are recommended at all storm drain inlets within the boundary of a development project. The marker should be placed in clear sight facing toward anyone approaching the inlet from either side. All storm drain inlet locations should be identified on the development site map.

## Designing New Installations

The following methods should be considered for inclusion in the project design and show on project plans:

- Provide stenciling or labeling of all storm drain inlets and catch basins, constructed or modified, within the project area with prohibitive language. Examples include "NO DUMPING



– DRAINS TO OCEAN” and/or other graphical icons to discourage illegal dumping.

- Post signs with prohibitive language and/or graphical icons, which prohibit illegal dumping at public access points along channels and creeks within the project area.

Note - Some local agencies have approved specific signage and/or storm drain message placards for use. Consult local agency stormwater staff to determine specific requirements for placard types and methods of application.

### ***Redeveloping Existing Installations***

Various jurisdictional stormwater management and mitigation plans (SUSMP, WQMP, etc.) define “redevelopment” in terms of amounts of additional impervious area, increases in gross floor area and/or exterior construction, and land disturbing activities with structural or impervious surfaces. If the project meets the definition of “redevelopment”, then the requirements stated under “designing new installations” above should be included in all project design plans.

### **Additional Information**

#### ***Maintenance Considerations***

- Legibility of markers and signs should be maintained. If required by the agency with jurisdiction over the project, the owner/operator or homeowner’s association should enter into a maintenance agreement with the agency or record a deed restriction upon the property title to maintain the legibility of placards or signs.

#### ***Placement***

- Signage on top of curbs tends to weather and fade.
- Signage on face of curbs tends to be worn by contact with vehicle tires and sweeper brooms.

### **Supplemental Information**

#### ***Examples***

- Most MS4 programs have storm drain signage programs. Some MS4 programs will provide stencils, or arrange for volunteers to stencil storm drains as part of their outreach program.

### **Other Resources**

A Manual for the Standard Urban Stormwater Mitigation Plan (SUSMP), Los Angeles County Department of Public Works, May 2002.

Model Standard Urban Storm Water Mitigation Plan (SUSMP) for San Diego County, Port of San Diego, and Cities in San Diego County, February 14, 2002.

Model Water Quality Management Plan (WQMP) for County of Orange, Orange County Flood Control District, and the Incorporated Cities of Orange County, Draft February 2003.

Ventura Countywide Technical Guidance Manual for Stormwater Quality Control Measures, July 2002.



## Description

Trash storage areas are areas where a trash receptacle (s) are located for use as a repository for solid wastes. Stormwater runoff from areas where trash is stored or disposed of can be polluted. In addition, loose trash and debris can be easily transported by water or wind into nearby storm drain inlets, channels, and/or creeks. Waste handling operations that may be sources of stormwater pollution include dumpsters, litter control, and waste piles.

## Approach

This fact sheet contains details on the specific measures required to prevent or reduce pollutants in stormwater runoff associated with trash storage and handling. Preventative measures including enclosures, containment structures, and impervious pavements to mitigate spills, should be used to reduce the likelihood of contamination.

## Suitable Applications

Appropriate applications include residential, commercial and industrial areas planned for development or redevelopment. (Detached residential single-family homes are typically excluded from this requirement.)

## Design Considerations

Design requirements for waste handling areas are governed by Building and Fire Codes, and by current local agency ordinances and zoning requirements. The design criteria described in this fact sheet are meant to enhance and be consistent with these code and ordinance requirements. Hazardous waste should be handled in accordance with legal requirements established in Title 22, California Code of Regulation.

Wastes from commercial and industrial sites are typically hauled by either public or commercial carriers that may have design or access requirements for waste storage areas. The design criteria in this fact sheet are recommendations and are not intended to be in conflict with requirements established by the waste hauler. The waste hauler should be contacted prior to the design of your site trash collection areas. Conflicts or issues should be discussed with the local agency.

## Designing New Installations

Trash storage areas should be designed to consider the following structural or treatment control BMPs:

- Design trash container areas so that drainage from adjoining roofs and pavement is diverted around the area(s) to avoid run-on. This might include berming or grading the waste handling area to prevent run-on of stormwater.
- Make sure trash container areas are screened or walled to prevent off-site transport of trash.

## Design Objectives

- Maximize Infiltration
- Provide Retention
- Slow Runoff
- Minimize Impervious Land Coverage
- Prohibit Dumping of Improper Materials
- Contain Pollutants
- Collect and Convey



- Use lined bins or dumpsters to reduce leaking of liquid waste.
- Provide roofs, awnings, or attached lids on all trash containers to minimize direct precipitation and prevent rainfall from entering containers.
- Pave trash storage areas with an impervious surface to mitigate spills.
- Do not locate storm drains in immediate vicinity of the trash storage area.
- Post signs on all dumpsters informing users that hazardous materials are not to be disposed of therein.

***Redeveloping Existing Installations***

Various jurisdictional stormwater management and mitigation plans (SUSMP, WQMP, etc.) define “redevelopment” in terms of amounts of additional impervious area, increases in gross floor area and/or exterior construction, and land disturbing activities with structural or impervious surfaces. The definition of “redevelopment” must be consulted to determine whether or not the requirements for new development apply to areas intended for redevelopment. If the definition applies, the steps outlined under “designing new installations” above should be followed.

**Additional Information*****Maintenance Considerations***

The integrity of structural elements that are subject to damage (i.e., screens, covers, and signs) must be maintained by the owner/operator. Maintenance agreements between the local agency and the owner/operator may be required. Some agencies will require maintenance deed restrictions to be recorded of the property title. If required by the local agency, maintenance agreements or deed restrictions must be executed by the owner/operator before improvement plans are approved.

**Other Resources**

A Manual for the Standard Urban Stormwater Mitigation Plan (SUSMP), Los Angeles County Department of Public Works, May 2002.

Model Standard Urban Storm Water Mitigation Plan (SUSMP) for San Diego County, Port of San Diego, and Cities in San Diego County, February 14, 2002.

Model Water Quality Management Plan (WQMP) for County of Orange, Orange County Flood Control District, and the Incorporated Cities of Orange County, Draft February 2003.

Ventura Countywide Technical Guidance Manual for Stormwater Quality Control Measures, July 2002.



# A Citizen's Guide to Understanding Stormwater



United States Environmental Protection Agency  
**EPA**

EPA 833-B-03-002

January 2003

How to Access This Guide: [www.epa.gov/stormwater](http://www.epa.gov/stormwater)  
This document is available in Spanish and other languages. For more information, contact the National Technical Support Center at [www.epa.gov/ntsc](http://www.epa.gov/ntsc).



## After the Storm

For more information contact:  
[www.epa.gov/nps](http://www.epa.gov/nps)  
or visit  
[www.epa.gov/npdes/stormwater](http://www.epa.gov/npdes/stormwater)



### What is stormwater runoff?



Stormwater runoff occurs when precipitation from rain or snowmelt flows over the ground. Impervious surfaces like driveways, sidewalks, and streets prevent stormwater from naturally soaking into the ground.

### Why is stormwater runoff a problem?



Stormwater can pick up debris, chemicals, dirt, and other pollutants and flow into a storm sewer system or directly to a lake, stream, river, wetland, or coastal water. Anything that enters a storm sewer system is discharged untreated into the waterbodies we use for swimming, fishing, and providing drinking water.

### The effects of pollution

Polluted stormwater runoff can have many adverse effects on plants, fish, animals, and people.

- ◆ Sediment can cloud the water and make it difficult or impossible for aquatic plants to grow. Sediment also can destroy aquatic habitats.
- ◆ Excess nutrients can cause algae blooms. When algae die, they sink to the bottom and decompose in a process that removes oxygen from the water. Fish and other aquatic organisms can't exist in water with low dissolved oxygen levels.
- ◆ Bacteria and other pathogens can wash into swimming areas and create health hazards, often making beach closures necessary.
- ◆ Debris—plastic bags, six-pack rings, bottles, and cigarette butts—washed into waterbodies can choke, suffocate, or disable aquatic life like ducks, fish, turtles, and birds.
- ◆ Household hazardous wastes like insecticides, pesticides, paint, solvents, used motor oil, and other auto fluids can poison aquatic life. Land animals and people can become sick or die from eating diseased fish and shellfish or ingesting polluted water.



◆ Polluted stormwater often affects drinking water sources. This, in turn, can affect human health and increase drinking water treatment costs.



# Stormwater Pollution Solutions

## Residential



Recycle or properly dispose of household products that contain chemicals, such as insecticides, pesticides, paint, solvents, and used motor oil and other auto fluids. Don't pour them onto the ground or into storm drains.

### Lawn care

Excess fertilizers and pesticides applied to lawns and gardens wash off and pollute streams. In addition, yard clippings and leaves can wash into storm drains and contribute nutrients and organic matter to streams.



- ◆ Don't overwater your lawn. Consider using a soaker hose instead of a sprinkler.
- ◆ Use pesticides and fertilizers sparingly. When use is necessary, use these chemicals in the recommended amounts. Use organic mulch or safer pest control methods whenever possible.
- ◆ Compost or mulch yard waste. Don't leave it in the street or sweep it into storm drains or streams.
- ◆ Cover piles of dirt or mulch being used in landscaping projects.

### Septic systems

Leaking and poorly maintained septic systems release nutrients and pathogens (bacteria and viruses) that can be picked up by stormwater and discharged into nearby waterbodies. Pathogens can cause public health problems and environmental concerns.



- ◆ Inspect your system every 3 years and pump your tank as necessary (every 3 to 5 years).
- ◆ Don't dispose of household hazardous waste in sinks or toilets.

### Auto care

Washing your car and degreasing auto parts at home can send detergents and other contaminants through the storm sewer system. Dumping automotive fluids into storm drains has the same result as dumping the materials directly into a waterbody.



- ◆ Use a commercial car wash that treats or recycles its wastewater, or wash your car on your yard so the water infiltrates into the ground.
- ◆ Repair leaks and dispose of used auto fluids and batteries at designated drop-off or recycling locations.

### Pet waste

Pet waste can be a major source of bacteria and excess nutrients in local waters.



- ◆ When walking your pet, remember to pick up the waste and dispose of it properly. Flushing pet waste is the best disposal method. Leaving pet waste on the ground increases public health risks by allowing harmful bacteria and nutrients to wash into the storm drain and eventually into local waterbodies.



Education is essential to changing people's behavior. Signs and markers near storm drains warn residents that pollutants entering the drains will be carried untreated into a local waterbody.

## Residential landscaping

**Permeable Pavement**—Traditional concrete and asphalt don't allow water to soak into the ground. Instead these surfaces rely on storm drains to divert unwanted water. Permeable pavement systems allow rain and snowmelt to soak through, decreasing stormwater runoff.

**Rain Barrels**—You can collect rainwater from rooftops in mosquito-proof containers. The water can be used later on lawn or garden areas.



**Rain Gardens and Grassy Swales**—Specially designed areas planted with native plants can provide natural places for



rainwater to collect and soak into the ground. Rain from rooftop areas or paved areas can be diverted into these areas rather than into storm drains.

**Vegetated Filter Strips**—Filter strips are areas of native grass or plants created along roadways or streams. They trap the pollutants stormwater picks up as it flows across driveways and streets.



## Commercial

Dirt, oil, and debris that collect in parking lots and paved areas can be washed into the storm sewer system and eventually enter local waterbodies.

- ◆ Sweep up litter and debris from sidewalks, driveways and parking lots, especially around storm drains.
- ◆ Cover grease storage and dumpsters and keep them clean to avoid leaks.
- ◆ Report any chemical spill to the local hazardous waste cleanup team. They'll know the best way to keep spills from harming the environment.

Erosion controls that aren't maintained can cause excessive amounts of sediment and debris to be carried into the stormwater system. Construction vehicles can leak fuel, oil, and other harmful fluids that can be picked up by stormwater and deposited into local waterbodies.

- ◆ Divert stormwater away from disturbed or exposed areas of the construction site.
- ◆ Install silt fences, vehicle mud removal areas, vegetative cover, and other sediment and erosion controls and properly maintain them, especially after rainstorms.
- ◆ Prevent soil erosion by minimizing disturbed areas during construction projects, and seed and mulch bare areas as soon as possible.

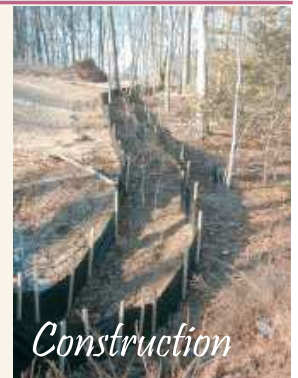

## Construction



## Agriculture

Lack of vegetation on streambanks can lead to erosion. Overgrazed pastures can also contribute excessive amounts of sediment to local waterbodies. Excess fertilizers and pesticides can poison aquatic animals and lead to destructive algae blooms. Livestock in streams can contaminate waterways with bacteria, making them unsafe for human contact.



- ◆ Keep livestock away from streambanks and provide them a water source away from waterbodies.
- ◆ Store and apply manure away from waterbodies and in accordance with a nutrient management plan.
- ◆ Vegetate riparian areas along waterways.
- ◆ Rotate animal grazing to prevent soil erosion in fields.
- ◆ Apply fertilizers and pesticides according to label instructions to save money and minimize pollution.



## Forestry

Improperly managed logging operations can result in erosion and sedimentation.

- ◆ Conduct preharvest planning to prevent erosion and lower costs.
- ◆ Use logging methods and equipment that minimize soil disturbance.
- ◆ Plan and design skid trails, yard areas, and truck access roads to minimize stream crossings and avoid disturbing the forest floor.
- ◆ Construct stream crossings so that they minimize erosion and physical changes to streams.
- ◆ Expedite revegetation of cleared areas.

## Automotive Facilities

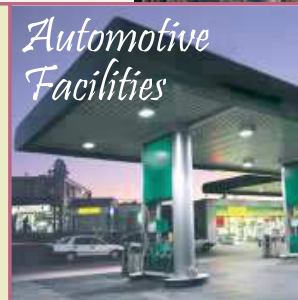

Uncovered fueling stations allow spills to be washed into storm drains. Cars waiting to be repaired can leak fuel, oil, and other harmful fluids that can be picked up by stormwater.

- ◆ Clean up spills immediately and properly dispose of cleanup materials.
- ◆ Provide cover over fueling stations and design or retrofit facilities for spill containment.
- ◆ Properly maintain fleet vehicles to prevent oil, gas, and other discharges from being washed into local waterbodies.
- ◆ Install and maintain oil/water separators.





# Stormwater Pollution Found in Your Area!

**This is not a citation.**

This is to inform you that our staff found the following pollutants in the storm sewer system in your area. This storm sewer system leads directly to

- Motor oil
- Oil filters
- Antifreeze/  
transmission fluid
- Paint
- Solvent/degreaser
- Cooking grease
- Detergent
- Home improvement waste (concrete,  
mortar)
- Pet waste
- Yard waste (leaves, grass, mulch)
- Excessive dirt and  
gravel
- Trash
- Construction debris
- Pesticides and  
fertilizers
- Other



**For more information or to report  
an illegal discharge of  
pollutants, please call:**

**Riverside County Residents, Call . . .  
1-800-506-2555**



[www.epa.gov/npdes/stormwater](http://www.epa.gov/npdes/stormwater)

EPA 833-F-03-002

April 2003

Stormwater runoff is precipitation from rain or snowmelt that flows over the ground. As it flows, it can pick up debris, chemicals, dirt, and other pollutants and deposit them into a storm sewer system or waterbody

Anything that enters a storm sewer system is discharged untreated into the waterbodies we use for swimming, fishing, and providing drinking water.

**Remember:  
Only Rain Down the Drain**

To keep the stormwater leaving your home or workplace clean, follow these simple guidelines:

- ◆ Use pesticides and fertilizers sparingly
- ◆ Repair auto leaks.
- ◆ Dispose of household hazardous waste, used auto fluids (antifreeze, oil, etc.), and batteries at designated collection or recycling locations.
- ◆ Clean up after your pet.
- ◆ Use a commercial car wash or wash your car on a lawn or other unpaved surface.
- ◆ Sweep up yard debris rather than hosing down areas. Compost or recycle yard waste when possible.
- ◆ Clean paint brushes in a sink, not outdoors. Properly dispose of excess paints through a household hazardous waste collection program.
- ◆ Sweep up and properly dispose of construction debris like concrete and mortar.



# Stormwater Pollution

What you should know for...



Best Management Practices (BMPs) for:

- Developers
- General Contractors
- Home Builders
- Construction Inspectors
- Anyone in the construction business

To report a hazardous materials spill, call:

Riverside County Hazardous Materials Emergency Response Team

(909) 358-5055 8:00 a.m. – 5:00 p.m.

(909) 358-5245 after 5:00 p.m.

In an emergency call: 911

For recycling and hazardous waste disposal, call:

(909) 358-5055

To report an illegal dumping or a clogged storm drain, call:

1-800-506-2555

To order additional brochures or to obtain information on other pollution prevention activities, please call (909) 955-1200 or visit the Stormwater/CleanWater Protection Program website at:  
[www.co.riverside.ca.us/depts/flood/waterqualityupdates.asp](http://www.co.riverside.ca.us/depts/flood/waterqualityupdates.asp)



The Stormwater/CleanWater Protection Program gratefully acknowledges the Santa Clara Valley Nonpoint Pollution Control Program, Alameda Countywide CleanWater Program and the City of Los Angeles Stormwater Management Division for information provided in this brochure.

## Stormwater Pollution . . . What You Should Know

Riverside County has two drainage systems - sewers and storm drains. The storm drain system was designed to reduce flooding by carrying excess rainwater away from streets and developed areas. Since the storm drain system does not provide for water treatment, it also serves the *unintended* function of transporting pollutants directly to our local waterways.

*Unlike sanitary sewers, storm drains are not connected to a wastewater treatment plant – they flow directly to our local streams, rivers and lakes.*

Stormwater runoff is a part of the natural hydrologic process. However, land development and construction activities can significantly alter natural drainage processes and introduce pollutants into stormwater runoff. Polluted stormwater runoff from construction sites has been identified as a major source of water pollution in California. It jeopardizes the quality of our local waterways and can pose a serious threat to the health of our aquatic ecosystems.



## The Cities and County of Riverside Stormwater/CleanWater Protection Program

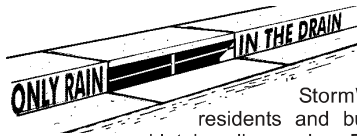

Because preventing pollution is much easier and less costly than cleaning up "after the fact," the Cities and County of Riverside Stormwater/CleanWater Protection Program informs residents and businesses on pollution prevention activities. This pamphlet describes various Best Management Practices (BMPs) that construction site operators can use to prevent stormwater pollution.

In accordance with applicable federal and state law, the Cities and County of Riverside have adopted ordinances for stormwater management and discharge control that **prohibit** the discharge of pollutants into the storm drain system or local surface water. This includes discharges from construction sites containing sediment, concrete, mortar, paint, solvents, lubricants, vehicle fluids, fuel, pesticides, and construction debris.

**PLEASE NOTE:** The Federal, State and local regulations strictly prohibit the discharge of sediment and pollutants into the streets, the storm drain system or waterways. As an owner, operator or supervisor of a construction site, you may be held financially responsible for any environmental damage caused by your subcontractors or employees.

## STORMWATER POLLUTION FROM CONSTRUCTION ACTIVITIES

The two most common sources of stormwater pollution problems associated with construction activities are **erosion** and **sedimentation**. Failure to maintain adequate erosion and sediment controls at construction sites often results in sediment discharges into the storm drain system, creating multiple problems once it enters local waterways.

Construction vehicles and heavy equipment can also track significant amounts of mud and sediment onto adjacent streets. Additionally, wind may transport construction materials and wastes into streets storm drains, or directly into our local waterways.



- State Water Resources Control Board  
 Division of Water Quality  
 1001 I Street  
 Sacramento CA 95814  
 (916) 341-5455  
[www.swrcb.ca.gov/stormwtr/](http://www.swrcb.ca.gov/stormwtr/)
- Colorado River Basin Regional Water Quality Control Board - Region 7  
 73-720 Fred Waring Drive, Suite 100  
 Palm Desert, CA 92260  
 (760) 346-7491  
[www.swrcb.ca.gov/~rwqcb7/](http://www.swrcb.ca.gov/~rwqcb7/)
- Santa Ana Regional Water Quality Control Board - Region 8  
 3737 Main Street, Suite 500  
 Riverside, CA 92501-3348  
 (909) 782-4130  
[www.swrcb.ca.gov/~rwqcb8/](http://www.swrcb.ca.gov/~rwqcb8/)
- San Diego Regional Water Quality Control Board - Region 9  
 9771 Clairmont Mesa Blvd., Suite A  
 San Diego, CA 92124  
 (858) 467-2952  
[www.swrcb.ca.gov/~rwqcb9/](http://www.swrcb.ca.gov/~rwqcb9/)

## Resources

## What Should You Do?

### Advance Planning to Prevent Pollution

- Remove existing vegetation only as needed.
- Schedule excavation, grading, and paving operations for dry weather periods, if possible.
- Designate a specific area of the construction site, well away from storm drain inlets or watercourses, for material storage and equipment maintenance.
- Develop and implement an effective combination of erosion and sediment controls for the construction site.
- Practice source reduction by ordering only the amount of materials that are needed to finish the project.
- Educate your employees and subcontractors about stormwater management requirements and their pollution prevention responsibilities.
- Control the amount of surface runoff at the construction site by impeding internally generated flows and using berms or drainage ditches to direct incoming offsite flows to go around the site. *Note: Consult local drainage policies for more information.*

## BEST MANAGEMENT PRACTICES

The following Best Management Practices (BMPs) can significantly reduce pollutant discharges from your construction site. Compliance with stormwater regulations can be as simple as minimizing stormwater contact with potential pollutants by providing covers and secondary containment for construction materials, designating areas away from storm drain systems for storing equipment and materials and implementing good housekeeping practices at the construction site.

- Protect all storm drain inlets and streams located near the construction site to prevent sediment-laden water from entering the storm drain system.
- Limit access to and from the site. Stabilize construction entrances/exits to minimize the track out of dirt and mud onto adjacent streets. Conduct frequent street sweeping.
- Protect stockpiles and construction materials from winds and rain by storing them under a roof, secured impermeable tarp or plastic sheeting.
- Avoid storing or stockpiling materials near storm drain inlets, gullies or streams.
- Phase grading operations to limit disturbed areas and duration of exposure.
- Perform major maintenance and repairs of vehicles and equipment offsite.
- Wash out concrete mixers only in designated washout areas at the construction site.
- Set-up and operate small concrete mixers on tarps or heavy plastic drop cloths.
- Keep construction sites clean by removing trash, debris, wastes, etc. on a regular basis.
- Clean-up spills immediately using dry clean-up methods (e.g., absorbent materials such as cat litter, sand or rags for liquid spills; sweeping for dry spills such as cement, mortar or fertilizer) and by removing the contaminated soil from spills on dirt areas.
- Prevent erosion by implementing any or a combination of soil stabilization practices such as mulching, surface roughening, permanent or temporary seeding.
- Maintain all vehicles and equipment in good working condition. Inspect frequently for leaks, and repair promptly.
- Practice proper waste disposal. Many construction materials and wastes, including solvents, water-based paint, vehicle fluids, broken asphalt and concrete, wood, and cleared vegetation can be recycled. Materials that cannot be recycled must be taken to an appropriate landfill or disposed of as hazardous waste.
- Cover open dumpsters with secured tarps or plastic sheeting. Never clean out a dumpster by washing it down on the construction site.
- Arrange for an adequate debris disposal schedule to insure that dumpsters do not overflow.

## GENERAL CONSTRUCTION ACTIVITIES STORMWATER PERMIT (Construction Activities General Permit)

The State Water Resources Control Board (SWRCB) adopted a new Construction Activities General Permit (WQ Order No. 99-08DWQ) on August 19, 1999, superseding the now expired SWRCB statewide General Permit (WQ Order No. 92-08DWQ). This permit is administered and enforced by the SWRCB and the local Regional Water Quality Control Boards (RWQCB). The updated Construction Activities General Permit establishes a number of new stormwater management requirements for construction site operator.

**NOTE:** Some construction activities stormwater permits are issued on a regional basis. Consult your local RWQCB to find out if your project requires coverage under any of these permits.

### Frequently Asked Questions:

#### Does my construction site require coverage under the Construction Activities General Permit?

Yes, if construction activity results in the disturbance of five or more acres of total land area or is part of a common plan of development that results in the disturbance of five or more acres.

#### How do I obtain coverage under the Construction Activities General Permit?

Obtain the permit package and submit the completed Notice of Intent (NOI) form to the

SWRCB prior to grading or disturbing soil at the construction site. For ongoing construction activity involving a change of ownership, the new owner must submit a new NOI within 30 days of the date of change of ownership. The completed NOI along with the required fee should be mailed to the SWRCB.

#### What must I do to comply with the requirements of the Construction Activities General Permit?

- Implement BMPs for non-stormwater discharges year-round.
- Prepare and implement a Stormwater Pollution Prevention Plan (SWPPP) prior to commencing construction activities.
- Keep a copy of the SWPPP at the construction site for the entire duration of the project.
- Calculate the anticipated stormwater runoff.
- Implement an effective combination of erosion and sediment control on all soil disturbed areas.
- Conduct site inspections prior to anticipated storm events, every 24-hours during extended storm events, and after actual storm event.
- Perform repair and maintenance of BMPs as soon as possible after storm events depending upon worker safety.

- Update the SWPPP as needed, to manage pollutants or reflect changes in site conditions.
- Include description of post construction BMPs at the construction site, including parties responsible for long-term maintenance.

**NOTE:** Please refer to the Construction Activities General Permit for detailed information. You may contact the SWRCB, your local RWQCB, or visit the SWRCB website at [www.swrcb.ca.gov/stormwtr/](http://www.swrcb.ca.gov/stormwtr/) to obtain a State Construction Activities Stormwater General Permit packet.

#### How long is this Construction Activities General Permit in effect?

The Permit coverage stays in effect until you submit a Notice of Termination (NOT) to the SWRCB. For the purpose of submitting a NOT, all soil disturbing activities have to be completed and one of the three following criteria has to be met:

1. Change of ownership;
2. A uniform vegetative cover with 70 percent coverage has been established; or,
3. Equivalent stabilization measures such as the use of reinforced channel liners, soil cement, fiber matrices, geotextiles, etc., have been employed.





---

## Objectives

---

- Cover
- Contain
- Educate
- Reduce/Minimize
- Product Substitution

## Description

Accidental releases of materials from above ground liquid storage tanks, drums, and dumpsters present the potential for contaminating stormwaters with many different pollutants. Tanks may store many potential stormwater runoff pollutants, such as gasoline, aviation gas, diesel fuel, ammonia, solvents, syrups, etc. Materials spilled, leaked, or lost from storage tanks may accumulate in soils or on other surfaces and be carried away by rainfall runoff. These source controls apply to containers located outside of a building used to temporarily store liquid materials and include installing safeguards against accidental releases, installing secondary containment, conducting regular inspections, and training employees in standard operating procedures and spill cleanup techniques.

## Approach

### *Pollution Prevention*

- Educate employees about pollution prevention measures and goals
- Keep an accurate, up-to-date inventory of the materials delivered and stored on-site. Re-evaluate inventory needs and consider purchasing alternative products. Properly dispose of outdated products.
- Try to keep chemicals in their original containers, and keep them well labeled.

---

## Targeted Constituents

---

Sediment	
Nutrients	✓
Trash	
Metals	✓
Bacteria	
Oil and Grease	✓
Organics	✓
Oxygen Demanding	✓



***Suggested Protocols****General*

- Develop an operations plan that describes procedures for loading and/or unloading. Refer to SC-30 Outdoor Loading/Unloading for more detailed BMP information pertaining to loading and unloading of liquids.
- Protect materials from rainfall, runoff, and wind dispersal:
  - Cover the storage area with a roof.
  - Minimize stormwater runoff by enclosing the area or building a berm around it.
  - Use a “doghouse” structure for storage of liquid containers.
  - Use covered dumpsters for waste product containers.
- Employ safeguards against accidental releases:
  - Provide overflow protection devices to warn operator or automatic shut down transfer pumps.
  - Provide protection guards (bollards) around tanks and piping to prevent vehicle or forklift damage, and
  - Provide clear tagging or labeling, and restricting access to valves to reduce human error.
- Berm or surround tank or container with secondary containment system using dikes, liners, vaults, or double walled tanks.
- Contact the appropriate regulatory agency regarding environmental compliance for facilities with “spill ponds” designed to intercept, treat, and/or divert spills.
- Have registered and specifically trained professional engineers can identify and correct potential problems such as loose fittings, poor welding, and improper or poorly fitted gaskets for newly installed tank systems.

*Storage Areas*

- Provide storage tank piping located below product level with a shut-off valve at the tank; ideally this valve should be an automatic shear valve with the shut-off located inside the tank.
- Provide barriers such as posts or guard rails, where tanks are exposed, to prevent collision damage with vehicles.
- Provide secure storage to prevent vandalism.
- Place tight-fitting lids on all containers.
- Enclose or cover the containers where they are stored.

- Raise the containers off the ground by use of pallet or similar method, with provisions for spill control and secondary containment.
- Contain the material in such a manner that if the container leaks or spills, the contents will not discharge, flow, or be washed into the storm drainage system, surface waters or groundwater.
- Place drip pans or absorbent materials beneath all mounted container taps, and at all potential drip and spill locations during filling and unloading of containers. Drip pans must be cleaned periodically, and all collected liquids and soiled absorbent materials must be reused/recycled or properly disposed.
- Ensure that any underground or aboveground storage tanks shall be designed and managed in accordance with applicable regulations, be identified as a potential pollution source, have secondary containment, such as a berm or dike with an impervious surface.
- Rainfall collected in secondary containment system must not contain pollutants for discharge to storm drain system.

## *Container Management*

- Keep containers in good condition without corrosion or leaky seams.
- Place containers in a lean-to structure or otherwise covered to keep rainfall from reaching the drums.
- Replace containers if they are deteriorating to the point where leakage is occurring. Keep all containers undercover to prevent the entry of stormwater. Employees should be made aware of the importance of keeping the containers free from leaks.
- Keep waste container drums in an area such as a service bay. Drums stored outside must be stored in a lean-to type structure, shed or walk-in container.

## *Storage of Hazardous Materials*

- Storage of reactive, ignitable, or flammable liquids must comply with the fire and hazardous waste codes.
- Place containers in a designated area that is paved, free of cracks and gaps, and impervious in order to contain leaks and spills. The area should also be covered.
- Surround stored hazardous materials and waste with a curb or dike to provide the volume to contain 10 percent of the volume of all of the containers or 110 percent of the volume of the largest container, whichever is greater. The area inside the curb should slope to a drain and a dead-end sump should be installed in the drain.

## *Inspection*

- Provide regular inspections:
  - Inspect storage areas regularly for leaks or spills.

- Conduct routine inspections and check for external corrosion of material containers. Also check for structural failure, spills and overfills due to operator error, failure of piping system.
- Check for leaks or spills during pumping of liquids or gases from truck or rail car to a storage facility or vice versa.
- Visually inspect new tank or container installations for loose fittings, poor welding, and improper or poorly fitted gaskets.
- Inspect tank foundations, connections, coatings, and tank walls and piping system. Look for corrosion, leaks, cracks, scratches, and other physical damage that may weaken the tank or container system.
- Replace containers that are leaking, corroded, or otherwise deteriorating with ones in good condition. If the liquid chemicals are corrosive, containers made of compatible materials must be used instead of metal drums.
- Label new or secondary containers with the product name and hazards.

***Training***

- Train employees (e.g. fork lift operators) and contractors in proper spill containment and cleanup. The employee should have the tools and knowledge to immediately begin cleaning up a spill if one should occur.
- Train employees in proper storage measures.
- Use a training log or similar method to document training.

***Spill Response and Prevention***

- Keep your Spill Prevention Control and Countermeasure (SPCC) Plan up-to-date, and implement accordingly.
- Have an emergency plan, equipment and trained personnel ready at all times to deal immediately with major spills.
- Collect all spilled liquids and properly dispose of them.
- Employees trained in emergency spill cleanup procedures should be present when dangerous waste, liquid chemicals, or other wastes are delivered.
- Operator errors can be prevented by using engineering safe guards and thus reducing accidental releases of pollutant.
- Store and maintain appropriate spill cleanup materials in a location known to all near the tank storage area.
- See Aboveground Tank Leak and Spill Control section of the Spill Prevention, Control & Cleanup fact sheet (SC-11) for additional information.



## ***Other Considerations***

- Storage sheds often must meet building and fire code requirements.
- The local fire district must be consulted for limitations on clearance of roof covers over containers used to store flammable materials.
- All specific standards set by federal and state laws concerning the storage of oil and hazardous materials must be met.
- Storage of reactive, ignitable, or flammable liquids should comply with the Uniform Fire Code and the National Electric Code.
- Storage of oil and hazardous materials must meet specific federal and state standards including:
  - Spill Prevention Control and Countermeasure Plan (SPCC) Plan
  - Secondary containment
  - Integrity and leak detection monitoring
  - Emergency preparedness plans

## **Requirements**

### ***Costs***

- Will vary depending on the size of the facility and the necessary controls, such as berms or safeguards against accidental controls.

### ***Maintenance***

- Conduct weekly inspection.
- Sweep and clean the storage area regularly if it is paved, do not hose down the area to a storm drain.

## **Supplemental Information**

- The most common causes of unintentional releases are:
  - Installation problems,
  - Failure of piping systems (pipes, pumps, flanges, couplings, hoses, and valves),
  - External corrosion and structural failure,
  - Spills and overfills due to operator error, and
  - Leaks during pumping of liquids or gases from truck or rail car to a storage tank or vice versa

***Further Detail of the BMP****Dikes*

One of the best protective measures against contamination of stormwater is diking. Containment dikes are berms or retaining walls that are designed to hold spills. Diking is an effective pollution prevention measure for above ground storage tanks and railcar or tank truck loading and unloading areas. The dike surrounds the area of concern and holds the spill, keeping spill materials separated from the stormwater side of the dike area. Diking can be used in any industrial or municipal facility, but it is most commonly used for controlling large spills or releases from liquid storage areas and liquid transfer areas.

- For single-wall tanks, containment dikes should be large enough to hold the contents of the storage tank for the facility plus rain water.
- For trucks, diked areas should be capable of holding an amount equal to the volume of the tank truck compartment. Diked construction material should be strong enough to safely hold spilled materials.
- Dike materials can consist of earth, concrete, synthetic materials, metal, or other impervious materials.
- Strong acids or bases may react with metal containers, concrete, and some plastics.
- Where strong acids or bases are stored, alternative dike materials should be considered. More active organic chemicals may need certain special liners for dikes.
- Dikes may also be designed with impermeable materials to increase containment capabilities.
- Dikes should be inspected during or after significant storms or spills to check for washouts or overflows.
- Regular checks of containment dikes to insure the dikes are capable of holding spills should be conducted.
- Inability of a structure to retain stormwater, dike erosion, soggy areas, or changes in vegetation indicate problems with dike structures. Damaged areas should be patched and stabilized immediately.
- Accumulated stormwater in the containment area should be analyzed for pollutants before it is released to surface waters. If pollutants are found or if stormwater quality is not determined, then methods other than discharging to surface waters should be employed (e.g., discharge to sanitary sewer if allowed).
- Earthen dikes may require special maintenance of vegetation such as mulching and irrigation.

## *Curbing*

Curbing is a barrier that surrounds an area of concern. Curbing is similar to containment diking in the way that it prevents spills and leaks from being released into the environment. The curbing is usually small scaled and does not contain large spills like diking. Curbing is common at many facilities in small areas where handling and transfer liquid materials occur. Curbing can redirect stormwater away from the storage area. It is useful in areas where liquid materials are transferred from one container to another. Asphalt is a common material used for curbing; however, curbing materials include earth, concrete, synthetic materials, metal, or other impenetrable materials.

- Spilled materials should be removed immediately from curbed areas to allow space for future spills.
- Curbs should have manually-controlled pump systems rather than common drainage systems for collection of spilled materials.
- The curbed area should be inspected regularly to clear clogging debris.
- Maintenance should also be conducted frequently to prevent overflow of any spilled materials as curbed areas are designed only for smaller spills.
- Curbing has the following advantages:
  - Excellent runoff control,
  - Inexpensive,
  - Ease of installment,
  - Provides option to recycle materials spilled in curb areas, and
  - Common industry practice.

## ***Examples***

The “doghouse” design has been used to store small liquid containers. The roof and flooring design prevent contact with direct rain or runoff. The doghouse has two solid structural walls and two canvas covered walls. The flooring is wire mesh about secondary containment. The unit has been used successfully at Lockheed Missile and Space Company in Sunnyvale.

## **References and Resources**

British Columbia Lake Stewardship Society. Best Management Practices to Protect Water Quality from Non-Point Source Pollution. March 2000  
<http://www.nalms.org/bclss/storage.html>

King County Stormwater Pollution Control Manual –  
<http://dnr.metrokc.gov/wlr/dss/spcm.htm>

San Diego Stormwater Co-permittees Jurisdictional Urban Runoff Management Program  
(URMP) -  
<http://www.projectcleanwater.org/pdf/Model%20Program%20Municipal%20Facilities.pdf>



# Outdoor Storage of Raw Materials SC-33



---

## Objectives

---

- Cover
- Contain
- Educate
- Reduce/Minimize

## Description

Raw materials, by-products, finished products, containers, and material storage areas exposed to rain and/or runoff can pollute stormwater. Stormwater can become contaminated when materials wash off or dissolve into water or are added to runoff by spills and leaks. Improper storage of these materials can result in accidental spills and the release of materials. To prevent or reduce the discharge of pollutants to stormwater from material delivery and storage, pollution prevention and source control measures, such as minimizing the storage of hazardous materials on-site, enclosing or covering materials, storing materials in a designated area, installing secondary containment, conducting regular inspections, preventing stormwater runoff and runoff, and training employees and subcontractors must be implemented.

---

## Targeted Constituents

---

Sediment	✓
Nutrients	✓
Trash	✓
Metals	
Bacteria	
Oil and Grease	✓
Organics	✓
Oxygen Demanding	✓

## Approach

### *Pollution Prevention*

- Employee education is paramount for successful BMP implementation.
- Minimize inventory of raw materials.
- Keep an accurate, up-to-date inventory of the materials delivered and stored on-site.
- Try to keep chemicals in their original containers, and keep them well labeled.



# SC-33 Outdoor Storage of Raw Materials

---

## *Suggested Protocols*

### *General*

- Store all materials inside. If this is not feasible, then all outside storage areas should be covered with a roof, and bermed, or enclosed to prevent stormwater contact. At the very minimum, a temporary waterproof covering made of polyethylene, polypropylene or hypalon should be used over all materials stored outside.
- Cover and contain the stockpiles of raw materials to prevent stormwater from running into the covered piles. The covers must be in place at all times when work with the stockpiles is not occurring. (applicable to small stockpiles only).
- If the stockpiles are so large that they cannot feasibly be covered and contained, implement erosion control practices at the perimeter of your site and at any catch basins to prevent erosion of the stockpiled material off site,
- Keep liquids in a designated area on a paved impervious surface within a secondary containment.
- Keep outdoor storage containers in good condition.
- Keep storage areas clean and dry.
- Design paved areas to be sloped in a manner that minimizes the pooling of water on the site, particularly with materials that may leach pollutants into stormwater and/or groundwater, such as compost, logs, and wood chips. A minimum slope of 1.5 percent is recommended.
- Secure drums stored in an area where unauthorized persons may gain access to prevent accidental spillage, pilferage, or any unauthorized use.
- Cover wood products treated with chromated copper arsenate, ammonical copper zinc arsenate, creosote, or pentachlorophenol with tarps or store indoors.

### *Raw Material Containment*

- Do not store chemicals, drums, or bagged materials directly on the ground. Place these items in secondary containers if applicable.
- Prevent the run-on of uncontaminated stormwater from adjacent areas as well as runoff of stormwater from the stockpile areas, by placing a curb along the perimeter of the area. The area inside the curb should slope to a drain. Liquids should be drained to the sanitary sewer if allowed. The drain must have a positive control such as a lock, valve, or plug to prevent release of contaminated liquids.
- Tanks should be bermed or surrounded by a secondary containment system.
- Release accumulated stormwater in petroleum storage areas prior to the next storm. At a minimum, water should pass through an oil/water separator and, if allowed, discharged to a sanitary sewer.

# Outdoor Storage of Raw Materials SC-33

---

## *Inspection*

- Conduct regular inspections of storage areas so that leaks and spills are detected as soon as possible.
- Conduct routine inspections and check for external corrosion of material containers. Also check for structural failure, spills and overfills due to operator error, failure of piping system.
- Check for leaks or spills during pumping of liquids or gases from truck or rail car to a storage facility or vice versa.
- Visually inspect new tank or container installations for loose fittings, poor welding, and improper or poorly fitted gaskets.
- Inspect tank foundations, connections, coatings, and tank walls and piping system. Look for corrosion, leaks, cracks, scratches, and other physical damage that may weaken the tank or container system.

## *Training*

- Employees should be well trained in proper material storage.
- Train employees and contractors in proper techniques for spill containment and cleanup.

## *Spill Response and Prevention*

- Refer to SC-11, Spill Prevention, Control & Cleanup.
- Keep your Spill Prevention Control and countermeasure (SPCC) plan up-to-date, and implement accordingly.
- Have spill cleanup materials readily available and in a known location.
- Cleanup spills immediately and use dry methods if possible.
- Properly dispose of spill cleanup material.
- Have employees trained in spill containment and cleanup present during loading/unloading of dangerous waste, liquid chemicals and other potentially hazardous materials.

## *Other Considerations*

- Storage sheds often must meet building and fire code requirements. Storage of reactive, ignitable, or flammable liquids must comply with the Uniform Fire Code and the National Electric Code.
- Space limitations may preclude storing some materials indoors.
- Some municipalities require that secondary containment areas (regardless of size) be connected to the sanitary sewer, prohibiting any hard connections to the storm drain. Storage sheds often must meet building and fire code requirements.
- The local fire district must be consulted for limitations on clearance of roof covers over containers used to store flammable materials.

# SC-33 Outdoor Storage of Raw Materials

---

## Requirements

### *Costs*

- Costs will vary depending on the size of the facility and the necessary controls. They should be low except where large areas may have to be covered.

### *Maintenance*

- Accurate and up-to-date inventories should be kept of all stored materials.
- Berms and curbs may require periodic repair and patching.
- Parking lots or other surfaces near bulk materials storage areas should be swept periodically to remove debris blown or washed from storage area.
- Sweep paved storage areas regularly for collection and disposal of loose solid materials, do not hose down the area to a storm drain or conveyance ditch.
- Keep outdoor storage areas in good condition (e.g. repair roofs, floors, etc. to limit releases to runoff).

## Supplemental Information

### *Further Detail of the BMP*

#### *Raw Material Containment*

Paved areas should be sloped in a manner that minimize the pooling of water on the site, particularly with materials that may leach pollutants into stormwater and/or groundwater, such as compost, logs, and wood chips. A minimum slope of 1.5 percent is recommended.

- Curbing should be placed along the perimeter of the area to prevent the runoff of uncontaminated stormwater from adjacent areas as well as runoff of stormwater from the stockpile areas.
- The storm drainage system should be designed to minimize the use of catch basins in the interior of the area as they tend to rapidly fill with manufacturing material.
- The area should be sloped to drain stormwater to the perimeter where it can be collected or to internal drainage alleyways where material is not stockpiled.
- If the raw material, by-product, or product is a liquid, more information for outside storage of liquids can be found under SC-31, Outdoor Container Storage.

### *Examples*

The “doghouse” design has been used to store small liquid containers. The roof and flooring design prevent contact with direct rain or runoff. The doghouse has two solid structural walls and two canvas covered walls. The flooring is wire mesh about secondary containment. The unit has been used successively at Lockheed Missile and Space Company in Sunnyvale.

## References and Resources

King County Stormwater Pollution Control Manual - <http://dnr.metrokc.gov/wlr/dss/spcm.htm>



# **Outdoor Storage of Raw Materials SC-33**

---

Model Urban Runoff Program: A How-To-Guide for Developing Urban Runoff Programs for Small Municipalities. Prepared by City of Monterey, City of Santa Cruz, California Coastal Commission, Monterey Bay National Marine Sanctuary, Association of Monterey Bay Area Governments, Woodward-Clyde, Central Coast Regional Water Quality Control Board. July 1998 (Revised February 2002 by the California Coastal Commission).

Orange County Stormwater Program

[http://www.ocwatersheds.com/StormWater/swp\\_introduction.asp](http://www.ocwatersheds.com/StormWater/swp_introduction.asp)

San Diego Stormwater Co-permittees Jurisdictional Urban Runoff Management Program (URMP)

<http://www.projectcleanwater.org/pdf/Model%20Program%20Municipal%20Facilities.pdf>

## Description

Improper storage and handling of solid wastes can allow toxic compounds, oils and greases, heavy metals, nutrients, suspended solids, and other pollutants to enter stormwater runoff. The discharge of pollutants to stormwater from waste handling and disposal can be prevented and reduced by tracking waste generation, storage, and disposal; reducing waste generation and disposal through source reduction, reuse, and recycling; and preventing run-on and runoff.

## Approach

Reduce potential for pollutant discharge through source control pollution prevention and BMP implementation. Successful implementation depends on effective training of employees on applicable BMPs and general pollution prevention strategies and objectives.

### General Pollution Prevention Protocols

- Accomplish reduction in the amount of waste generated using the following source controls:
  - ✓ Production planning and sequencing;
  - ✓ Process or equipment modification;
  - ✓ Raw material substitution or elimination;
  - ✓ Loss prevention and housekeeping;
  - ✓ Waste segregation and separation; and
  - ✓ Close loop recycling.
- Establish a material tracking system to increase awareness about material usage. This may reduce spills and minimize contamination, thus reducing the amount of waste produced.
- Recycle materials whenever possible.

## Objectives

- Cover
- Contain
- Educate
- Reduce/Minimize
- Product Substitution

## Targeted Constituents

Sediment	
Nutrients	
Trash	
Metals	✓
Bacteria	✓
Oil and Grease	✓
Organics	✓

## Minimum BMPs Covered

 Good Housekeeping	✓
 Preventative Maintenance	✓
 Spill and Leak Prevention and Response	✓
 Material Handling & Waste Management	✓
 Erosion and Sediment Controls	
 Employee Training Program	✓
 Quality Assurance Record Keeping	✓



- Use the entire product before disposing of the container.
- To the extent possible, store wastes under cover or indoors after ensuring all safety concerns such as fire hazard and ventilation are addressed.
- Provide containers for each waste stream at each work station. Allow time after shift to clean area.



## ***Good Housekeeping***

- Cover storage containers with leak proof lids or some other means. If waste is not in containers, cover all waste piles (plastic tarps are acceptable coverage) and prevent stormwater run-on and runoff with a berm. The waste containers or piles must be covered except when in use.
- Use drip pans or absorbent materials whenever grease containers are emptied by vacuum trucks or other means. Grease cannot be left on the ground. Collected grease must be properly disposed of as garbage.
- Dispose of rinse and wash water from cleaning waste containers into a sanitary sewer if allowed by the local sewer authority. Do not discharge wash water to the street or storm drain. Clean in a designated wash area that drains to a clarifier.
- Transfer waste from damaged containers into safe containers.
- Take special care when loading or unloading wastes to minimize losses. Loading systems can be used to minimize spills and fugitive emission losses such as dust or mist. Vacuum transfer systems can minimize waste loss.
- Keep the waste management area clean at all times by sweeping and cleaning up spills immediately.
- Use dry methods when possible (e.g., sweeping, use of absorbents) when cleaning around restaurant/food handling dumpster areas. If water must be used after sweeping/using absorbents, collect water and discharge through grease interceptor to the sewer.
- Stencil or demarcate storm drains on the facility's property with prohibitive message regarding waste disposal.
- Cover waste piles with temporary covering material such as reinforced tarpaulin, polyethylene, polyurethane, polypropylene or hypalon.
- If possible, move the activity indoor after ensuring all safety concerns such as fire hazard and ventilation are addressed.



## ***Preventative Maintenance***

- Prevent stormwater run-on from entering the waste management area by enclosing the area or building a berm around the area.
- Prevent waste materials from directly contacting rain.

- ❑ Cover waste piles with temporary covering material such as reinforced tarpaulin, polyethylene, polyurethane, polypropylene or hypalon.
- ❑ Cover the area with a permanent roof if feasible.
- ❑ Cover dumpsters to prevent rain from washing waste out of holes or cracks in the bottom of the dumpster.
- ❑ Check waste containers weekly for leaks and to ensure that lids are on tightly. Replace any that are leaking, corroded, or otherwise deteriorating.
- ❑ Sweep and clean the waste management area regularly. Use dry methods when possible (e.g., sweeping, vacuuming, use of absorbents) when cleaning around restaurant/food handling dumpster areas. If water must be used after sweeping/using absorbents, collect water and discharge through grease interceptor to the sewer.
- ❑ Inspect and replace faulty pumps or hoses regularly to minimize the potential of releases and spills.
- ❑ Repair leaking equipment including valves, lines, seals, or pumps promptly.



## ***Spill Response and Prevention Procedures***

- ❑ Keep your spill prevention and plan up-to-date.
- ❑ Have an emergency plan, equipment and trained personnel ready at all times to deal immediately with major spills.
- ❑ Collect all spilled liquids and properly dispose of them.
- ❑ Store and maintain appropriate spill cleanup materials in a location known to all near the designated wash area.
- ❑ Ensure that vehicles transporting waste have spill prevention equipment that can prevent spills during transport. Spill prevention equipment includes:
  - ✓ Vehicles equipped with baffles for liquid waste; and
  - ✓ Trucks with sealed gates and spill guards for solid waste.



## ***Material Handling and Waste Management***

### *Litter Control*

- ❑ Post “No Littering” signs and enforce anti-litter laws.
- ❑ Provide a sufficient number of litter receptacles for the facility.
- ❑ Clean out and cover litter receptacles frequently to prevent spillage.

### *Waste Collection*

- ❑ Keep waste collection areas clean.



- Inspect solid waste containers for structural damage regularly. Repair or replace damaged containers as necessary.
- Secure solid waste containers; containers must be closed tightly when not in use.
- Do not fill waste containers with washout water or any other liquid.
- Ensure that only appropriate solid wastes are added to the solid waste container. Certain wastes such as hazardous wastes, appliances, fluorescent lamps, pesticides, etc., may not be disposed of in solid waste containers (see chemical/ hazardous waste collection section below).
- Do not mix wastes; this can cause chemical reactions, make recycling impossible, and complicate disposal. Affix labels to all waste containers.

### *Chemical/Hazardous Wastes*

- Select designated hazardous waste collection areas on-site.
- Store hazardous materials and wastes in covered containers and protect them from vandalism.
- Place hazardous waste containers in secondary containment.
- Make sure that hazardous waste is collected, removed, and disposed of only at authorized disposal areas.
- Hazardous waste cannot be reused or recycled; it must be disposed of by a licensed hazardous waste hauler.



### **Employee Training Program**

- Educate employees about pollution prevention measures and goals.
- Train employees how to properly handle and dispose of waste using the source control BMPs described above.
- Train employees and subcontractors in proper hazardous waste management.
- Use a training log or similar method to document training.
- Ensure that employees are familiar with the site's spill control plan and/or proper spill cleanup procedures.



### **Quality Assurance and Record Keeping**

- Keep accurate maintenance logs that document minimum BMP activities performed for waste handling and disposal, types and quantities of waste disposed of, and any improvement actions.
- Keep accurate logs of spill response actions that document what was spilled, how it was cleaned up, and how the waste was disposed.

- Establish procedures to complete logs and file them in the central office.

## **Potential Capital Facility Costs and Operation & Maintenance Requirements**

### ***Facilities***

- Capital costs will vary substantially depending on the size of the facility and the types of waste handled. Significant capital costs may be associated with reducing wastes by modifying processes or implementing closed-loop recycling.
- Many facilities will already have indoor covered areas where waste materials will be stored and will require no additional capital expenditures for providing cover.
- If outdoor storage of wastes is required, construction of berms or other means to prevent stormwater run-on and runoff may require appropriate constructed systems for containment.
- Capital investments will likely be required at some sites if adequate cover and containment facilities do not exist and can vary significantly depending upon site conditions.

### ***Maintenance***

- Check waste containers weekly for leaks and to ensure that lids are on tightly. Replace any that are leaking, corroded, or otherwise deteriorating.
- Sweep and clean the waste management area regularly. Use dry methods when possible (e.g., sweeping, use of absorbents) when cleaning around restaurant/food handling dumpster areas. If water must be used after sweeping/using absorbents, collect water and discharge through grease interceptor to the sewer.
- Inspect and replace faulty pumps or hoses regularly to minimize the potential of releases and spills.
- Repair leaking equipment including valves, lines, seals, or pumps promptly.

## **References and Resources**

Minnesota Pollution Control Agency, *Industrial Stormwater Best Management Practices Guidebook*. Available online at: <http://www.pca.state.mn.us/index.php/view-document.html?gid=10557>.

New Jersey Department of Environmental Protection, 2013. *Basic Industrial Stormwater General Permit Guidance Document NJPDES General Permit No NJ0088315*, Revised. Available online at: [http://www.nj.gov/dep/dwq/pdf/5G2\\_guidance\\_color.pdf](http://www.nj.gov/dep/dwq/pdf/5G2_guidance_color.pdf).

Orange County Stormwater Program, *Best Management Practices for Industrial/Commercial Business Activities*. Available online at: <http://ocwatersheds.com/documents/bmp/industrialcommercialbusinessesactivities>

Oregon Department of Environmental Quality, 2013. *Industrial Stormwater Best Management Practices Manual- BMP 26 Fueling and Liquid Loading/Unloading Operations*. Available online at:  
<http://www.deq.state.or.us/wq/wqpermit/docs/IndBMP021413.pdf>.

Sacramento Stormwater Management Program. *Best Management Practices for Industrial Storm Water Pollution Control*. Available online at:  
<http://www.msa.saccounty.net/sactostormwater/documents/guides/industrial-BMP-manual.pdf>.

Sacramento County Environmental Management Stormwater Program: Best Management Practices. Available online at:  
<http://www.emd.saccounty.net/EnvHealth/Stormwater/Stormwater-BMPs.html>.

Santa Clara Valley Urban Runoff Pollution Prevention Program. <http://www.scvurppp-w2k.com/>

US EPA. National Pollutant Discharge Elimination System – Industrial Fact Sheet Series for Activities Covered by EPA’s Multi Sector General Permit. Available online at:  
<http://cfpub.epa.gov/npdes/stormwater/swsectors.cfm>.



## Objectives

- Cover
- Contain
- Educate
- Reduce/Minimize
- Product Substitution

## Description

Stormwater runoff from building and grounds maintenance activities can be contaminated with toxic hydrocarbons in solvents, fertilizers and pesticides, suspended solids, heavy metals, and abnormal pH. Utilizing the following protocols will prevent or reduce the discharge of pollutants to stormwater from building and grounds maintenance activities by washing and cleaning up with as little water as possible, following good landscape management practices, preventing and cleaning up spills immediately, keeping debris from entering the storm drains, and maintaining the stormwater collection system.

## Approach

### *Pollution Prevention*

- Switch to non-toxic chemicals for maintenance when possible.
- Choose cleaning agents that can be recycled.
- Encourage proper lawn management and landscaping, including use of native vegetation.
- Encourage use of Integrated Pest Management techniques for pest control.
- Encourage proper onsite recycling of yard trimmings.
- Recycle residual paints, solvents, lumber, and other material as much as possible.

## Targeted Constituents

Sediment	✓
Nutrients	✓
Trash	✓
Metals	✓
Bacteria	✓
Oil and Grease	✓
Organics	✓
Oxygen Demanding	✓





# SC-41 Building & Grounds Maintenance

---

## *Suggested Protocols*

### *Pressure Washing of Buildings, Rooftops, and Other Large Objects*

- In situations where soaps or detergents are used and the surrounding area is paved, pressure washers must use a waste water collection device that enables collection of wash water and associated solids. A sump pump, wet vacuum or similarly effective device must be used to collect the runoff and loose materials. The collected runoff and solids must be disposed of properly.
- If soaps or detergents are not used, and the surrounding area is paved, wash water runoff does not have to be collected but must be screened. Pressure washers must use filter fabric or some other type of screen on the ground and/or in the catch basin to trap the particles in wash water runoff.
- If you are pressure washing on a grassed area (with or without soap), runoff must be dispersed as sheet flow as much as possible, rather than as a concentrated stream. The wash runoff must remain on the grass and not drain to pavement. Ensure that this practice does not kill grass.

### *Landscaping Activities*

- Do not apply any chemicals (insecticide, herbicide, or fertilizer) directly to surface waters, unless the application is approved and permitted by the state.
- Dispose of grass clippings, leaves, sticks, or other collected vegetation as garbage, or by composting. Do not dispose of collected vegetation into waterways or storm drainage systems.
- Use mulch or other erosion control measures on exposed soils.
- Check irrigation schedules so pesticides will not be washed away and to minimize non-stormwater discharge.

### *Building Repair, Remodeling, and Construction*

- Do not dump any toxic substance or liquid waste on the pavement, the ground, or toward a storm drain.
- Use ground or drop cloths underneath outdoor painting, scraping, and sandblasting work, and properly dispose of collected material daily.
- Use a ground cloth or oversized tub for activities such as paint mixing and tool cleaning.
- Clean paint brushes and tools covered with water-based paints in sinks connected to sanitary sewers or in portable containers that can be dumped into a sanitary sewer drain. Brushes and tools covered with non-water-based paints, finishes, or other materials must be cleaned in a manner that enables collection of used solvents (e.g., paint thinner, turpentine, etc.) for recycling or proper disposal.

- Use a storm drain cover, filter fabric, or similarly effective runoff control mechanism if dust, grit, wash water, or other pollutants may escape the work area and enter a catch basin. The containment device(s) must be in place at the beginning of the work day, and accumulated dirty runoff and solids must be collected and disposed of before removing the containment device(s) at the end of the work day.
- If you need to de-water an excavation site, you may need to filter the water before discharging to a catch basin or off-site. In which case you should direct the water through hay bales and filter fabric or use other sediment filters or traps.
- Store toxic material under cover with secondary containment during precipitation events and when not in use. A cover would include tarps or other temporary cover material.

### *Mowing, Trimming, and Planting*

- Dispose of leaves, sticks, or other collected vegetation as garbage, by composting or at a permitted landfill. Do not dispose of collected vegetation into waterways or storm drainage systems.
- Use mulch or other erosion control measures when soils are exposed.
- Place temporarily stockpiled material away from watercourses and drain inlets, and berm or cover stockpiles to prevent material releases to the storm drain system.
- Consider an alternative approach when bailing out muddy water; do not put it in the storm drain, pour over landscaped areas.
- Use hand or mechanical weeding where practical.

### *Fertilizer and Pesticide Management*

- Follow all federal, state, and local laws and regulations governing the use, storage, and disposal of fertilizers and pesticides and training of applicators and pest control advisors.
- Follow manufacturers' recommendations and label directions. Pesticides must never be applied if precipitation is occurring or predicted. Do not apply insecticides within 100 feet of surface waters such as lakes, ponds, wetlands, and streams.
- Use less toxic pesticides that will do the job, whenever possible. Avoid use of copper-based pesticides if possible.
- Do not use pesticides if rain is expected.
- Do not mix or prepare pesticides for application near storm drains.
- Use the minimum amount needed for the job.
- Calibrate fertilizer distributors to avoid excessive application.
- Employ techniques to minimize off-target application (e.g. spray drift) of pesticides, including consideration of alternative application techniques.

# SC-41 Building & Grounds Maintenance

---

- Apply pesticides only when wind speeds are low.
- Work fertilizers into the soil rather than dumping or broadcasting them onto the surface.
- Irrigate slowly to prevent runoff and then only as much as is needed.
- Clean pavement and sidewalk if fertilizer is spilled on these surfaces before applying irrigation water.
- Dispose of empty pesticide containers according to the instructions on the container label.
- Use up the pesticides. Rinse containers, and use rinse water as product. Dispose of unused pesticide as hazardous waste.
- Implement storage requirements for pesticide products with guidance from the local fire department and County Agricultural Commissioner. Provide secondary containment for pesticides.

## *Inspection*

- Inspect irrigation system periodically to ensure that the right amount of water is being applied and that excessive runoff is not occurring. Minimize excess watering, and repair leaks in the irrigation system as soon as they are observed.

## *Training*

- Educate and train employees on use of pesticides and in pesticide application techniques to prevent pollution.
- Train employees and contractors in proper techniques for spill containment and cleanup.
- Be sure the frequency of training takes into account the complexity of the operations and the nature of the staff.

## *Spill Response and Prevention*

- Refer to SC-11, Spill Prevention, Control & Cleanup
- Keep your Spill Prevention Control and countermeasure (SPCC) plan up-to-date, and implement accordingly.
- Have spill cleanup materials readily available and in a known location.
- Cleanup spills immediately and use dry methods if possible.
- Properly dispose of spill cleanup material.

## *Other Considerations*

- Alternative pest/weed controls may not be available, suitable, or effective in many cases.

## **Requirements**

### **Costs**

- Overall costs should be low in comparison to other BMPs.

### **Maintenance**

- Sweep paved areas regularly to collect loose particles, and wipe up spills with rags and other absorbent material immediately, do not hose down the area to a storm drain.

## **Supplemental Information**

### **Further Detail of the BMP**

#### *Fire Sprinkler Line Flushing*

Building fire sprinkler line flushing may be a source of non-stormwater runoff pollution. The water entering the system is usually potable water though in some areas it may be non-potable reclaimed wastewater. There are subsequent factors that may drastically reduce the quality of the water in such systems. Black iron pipe is usually used since it is cheaper than potable piping but it is subject to rusting and results in lower quality water. Initially the black iron pipe has an oil coating to protect it from rusting between manufacture and installation; this will contaminate the water from the first flush but not from subsequent flushes. Nitrates, poly-phosphates and other corrosion inhibitors, as well as fire suppressants and antifreeze may be added to the sprinkler water system. Water generally remains in the sprinkler system a long time, typically a year, between flushes and may accumulate iron, manganese, lead, copper, nickel and zinc. The water generally becomes anoxic and contains living and dead bacteria and breakdown products from chlorination. This may result in a significant BOD problem and the water often smells. Consequently dispose fire sprinkler line flush water into the sanitary sewer. Do not allow discharge to storm drain or infiltration due to potential high levels of pollutants in fire sprinkler line water.

## **References and Resources**

California's Nonpoint Source Program Plan <http://www.swrcb.ca.gov/nps/index.html>

King County - <ftp://dnr.metrokc.gov/wlr/dss/spcm/Chapter%203.PDF>

Orange County Stormwater Program

[http://www.ocwatersheds.com/StormWater/swp\\_introduction.asp](http://www.ocwatersheds.com/StormWater/swp_introduction.asp)

Mobile Cleaners Pilot Program: Final Report. 1997. Bay Area Stormwater Management Agencies Association (BASSMA) <http://www.basmaa.org/>

Pollution from Surface Cleaning Folder. 1996. Bay Area Stormwater Management Agencies Association (BASMAA) <http://www.basmaa.org/>

San Diego Stormwater Co-permittees Jurisdictional Urban Runoff Management Program (URMP) -

<http://www.projectcleanwater.org/pdf/Model%20Program%20Municipal%20Facilities.pdf>



# Saltwater Pools

- Salt water pools, although different from regular pools, are in fact, sanitized using chlorine. A salt-chlorine generator separates the chlorine and sodium molecules in salt and reintroduces them into the pool water. The same harmful effects of chlorine still apply.
- A salt water pool is still maintained with chemicals such as Muriatic acid, soda ash and sodium carbonate to help keep a proper pH, total Alkalinity, Calcium Hardness and Stabilizer levels.



- It may be illegal to discharge salt water to land. The salt may kill plants and the build-up of salt in soil puts animals, plants, and groundwater at risk. Consult your city representatives to determine local requirements regarding salt water drainage.

**NEVER** put unused chemicals into the trash, onto the ground or down a storm drain.

**IMPORTANT:** The discharge of pollutants into the street, gutter, storm drain system or waterways - without a permit or waiver - **is strictly prohibited by local ordinances, state and federal law.** Violations may result in monetary fines and enforcement actions.

# Helpful telephone numbers and links

## RIVERSIDE COUNTY WATER AGENCIES:

City of Banning.....	(951) 922-3130
City of Beaumont/Cherry Valley.....	(951) 845-9581
City of Blythe.....	(760) 922-6161
City of Coachella.....	(760) 398-3502
City of Corona.....	(951) 736-2263
City of Hemet.....	(951) 765-3710
City of Norco.....	(951) 270 5607
City of Riverside Public Works.....	(951) 351-6140
City of San Jacinto.....	(951) 654-4041
Coachella Valley Water District.....	(760) 398-2651
Desert Water Agency (Palm Springs).....	(760) 323-4971
Eastern Municipal Water District.....	(951) 928-3777
Elsinore Valley Municipal Water District.....	(951) 674 3146
Elsinore Water District.....	(951) 674-2168
Farm Mutual Water Company.....	(951) 244-4198
Idyllwild Water District.....	(951) 659-2143
Indio Water Authority.....	(760) 391-4129
Jurupa Community Services District.....	(951) 685-7434
Lee Lake Water.....	(951) 658-3241
Mission Springs Water.....	(760) 329-6448
Rancho California Water District.....	(951) 296-6900
Ripley, CSA #62.....	(760) 922-4951
Riverside Co. Service Area #51.....	(760) 227-3203
Rubidoux Community Services District.....	(951) 684-7580
Valley Sanitary District.....	(760) 347-2356
Western Municipal Water District.....	(951) 789-5000
Yucaipa Valley Water District.....	(909) 797-5117

## CALL 1-800-506-2555 to:

- Report clogged storm drains or illegal storm drain disposal from residential, industrial, construction and commercial sites into public streets, storm drains and/or water bodies.
- Find out about our various storm drain pollution prevention materials.
- Locate the dates and times of Household Hazardous Waste (HHW) Collection Events.
- Request adult, neighborhood, or classroom presentations.
- Locate other County environmental services.
- Receive grasscycling information and composting workshop information.

Or visit our

Riverside County Flood Control and Water Conservation District website at: [www.rcflood.org](http://www.rcflood.org)

## Other links to additional storm drain pollution information:

- County of Riverside Environmental Health: [www.rivcoeh.org](http://www.rivcoeh.org)
- State Water Resources Control Board: [www.waterboards.ca.gov](http://www.waterboards.ca.gov)
- California Stormwater Quality Association: [www.casqa.org](http://www.casqa.org)
- United States Environmental Protection Agency (EPA): [www.epa.gov/compliance/assistance](http://www.epa.gov/compliance/assistance) (compliance assistance information)



Riverside County's, "Only Rain Down the Storm Drain" Pollution Prevention Program gratefully acknowledges the Bay Area Stormwater Management Agencies Association and the Cleaning Equipment Trade Association for information provided in this brochure.

# Guidelines for Maintaining your...



# Swimming Pool, Jacuzzi and Garden Fountain



## Where does the water go?

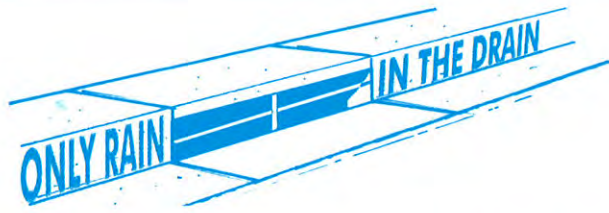

Pool, Jacuzzi and Fountain wastewater and rain water runoff (also called stormwater) that reach streets can enter the storm drain and be conveyed directly into local streams, rivers and lakes.



A storm drain's purpose is to prevent flooding by carrying rain water away from developed areas. Storm drains are not connected to sanitary sewers systems and treatment plants!

Wastewater, from residential swimming pools, Jacuzzis, fishponds and fountains, often contains chemicals used for sanitizing or cleansing purposes. Toxic chemicals (such as chlorine or copper-based algaecides) may pollute the environment when discharged into a storm drain system.

The Cities and County of Riverside have adopted ordinances that prohibit the discharge of wastewater to the street and storm drain system.



## Discharge Regulations

Regulatory requirements for discharging wastewater from your pool may differ from city to city. Chlorinated water should not be discharged into the street, storm drain or surface waters. Check with your water agency to see if disposal to the sanitary sewer line is allowed for pool discharges (see reverse for Riverside County sewer agencies).

If allowed, a hose can be run from the pool Jacuzzi, or fountain to the private sewer cleanout, washing machine drain or a sink or bathtub.

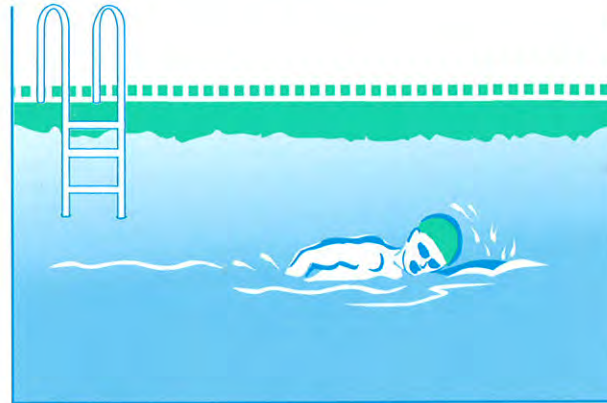

**If you cannot discharge to the sewer**, you may drain your fountain, pool, or jacuzzi to your landscaping by following these guidelines:

**First**, reduce or eliminate solids (e.g. debris, leaves or dirt) in the pool water and allow the chemicals in the pool water to dissipate before draining the pool (this could take up to 7 days, verify using a home pool test kit).

**Second**, slowly drain to a landscaped area away from buildings or structures. Control the flow to prevent soil erosion; it may take more than one day to empty. Do not allow sediment to enter the street, gutter or storm drain.

## Maintenance & Chemicals

### Cleaning Filters

Filter rinse water and backwash must be discharged to the sanitary sewer, on-site septic tank and drain field system (if properly designed and adequately sized), or a seepage pit. Alternatively, rinse water or backwash may be diverted to landscaped or dirt areas. Filter media and other non-hazardous solids should be picked up and disposed of in the trash.



### Algaecides

Avoid using copper-based algaecides unless absolutely necessary. Control algae with chlorine, organic polymers or other alternatives to copper-based pool chemicals. Copper is a heavy metal that can be toxic to aquatic life when you drain your pool.

### Chemical Storage and Handling

- Use only the amount indicated on product labels
- Store chlorine and other chemicals in a covered area to prevent runoff. Keep out of reach of children and pets.
- Chlorine kits, available at retail swimming pool equipment and supply stores, should be used to monitor the chlorine and pH levels before draining your pool.
- Chlorine and other pool chemicals should never be allowed to flow into the gutter or storm drain system.

Take unwanted chemicals to a Household Hazardous Waste (HHW) Collection Event. There's no cost for taking HHW items to collection events – it's FREE! Call 1-800-506-2555 for a schedule of HHW events in your community.





## Helpful telephone numbers and links:

### Riverside County Stormwater Protection Partners

Flood Control District	(951) 955-1200
County of Riverside	(951) 955-1000
City of Banning	(951) 922-3105
City of Beaumont	(951) 769-8520
City of Calimesa	(909) 795-9801
City of Canyon Lake	(951) 244-2955
Cathedral City	(760) 770-0327
City of Coachella	(760) 398-4978
City of Corona	(951) 736-2447
City of Desert Hot Springs	(760) 329-6411
City of Eastvale	(951) 361-0900
City of Hemet	(951) 765-2300
City of Indian Wells	(760) 346-2489
City of Indio	(760) 391-4000
City of Lake Elsinore	(951) 674-3124
City of La Quinta	(760) 777-7000
City of Menifee	(951) 672-6777
City of Moreno Valley	(951) 413-3000
City of Murrieta	(951) 304-2489
City of Norco	(951) 270-5607
City of Palm Desert	(760) 346-0611
City of Palm Springs	(760) 323-8299
City of Perris	(951) 943-6100
City of Rancho Mirage	(760) 324-4511
City of Riverside	(951) 361-0900
City of San Jacinto	(951) 654-7337
City of Temecula	(951) 694-6444
City of Wildomar	(951) 677-7751

### REPORT ILLEGAL STORM DRAIN DISPOSAL

1-800-506-2555 or e-mail us at  
[fcnpdes@rcflood.org](mailto:fcnpdes@rcflood.org)

- Riverside County Flood Control and Water Conservation District  
[www.rcflood.org](http://www.rcflood.org)

#### Online resources include:

- California Storm Water Quality Association  
[www.casqa.org](http://www.casqa.org)
- State Water Resources Control Board  
[www.waterboards.ca.gov](http://www.waterboards.ca.gov)
- Power Washers of North America  
[www.thepwna.org](http://www.thepwna.org)

# Stormwater Pollution

What you should know for...

## Outdoor Cleaning Activities and Professional Mobile Service Providers



### Storm drain pollution prevention information for:

- Car Washing / Mobile Detailers
- Window and Carpet Cleaners
- Power Washers
- Waterproofers / Street Sweepers
- Equipment cleaners or degreasers and all mobile service providers

Do you know where street flows actually go?

## Storm drains are NOT connected to sanitary sewer systems and treatment plants!



The primary purpose of storm drains is to carry *rain* water away from developed areas to prevent flooding. Pollutants discharged to storm drains are transported directly into rivers, lakes and streams. Soaps, degreasers, automotive fluids, litter and a host of materials are washed off buildings, sidewalks, plazas and parking areas. Vehicles and equipment must be properly managed to prevent the pollution of local waterways.

Unintentional spills by mobile service operators can flow into storm drains and pollute our waterways. **Avoid mishaps.** Always have a **Spill Response Kit** on hand to clean up unintentional spills. Only emergency **Mechanical** repairs should be done in City streets, using drip pans for spills. **Plumbing** should be done on private property. Always store chemicals in a leak-proof container and keep covered when not in use. **Window/Power Washing** waste water shouldn't be released into the streets, but should be disposed of in a sanitary sewer, landscaped area or in the soil. Soiled **Carpet Cleaning** wash water should be filtered before being discharged into the sanitary sewer. Dispose of all filter debris properly. **Car Washing/Detailing** operators should wash cars on private property and use a regulated hose nozzle for water flow control and runoff prevention. Capture and dispose of waste water and chemicals properly. Remember, storm drains are for receiving rain water runoff only.

**REPORT ILLEGAL  
STORM DRAIN  
DISPOSAL  
1-800-506-2555**

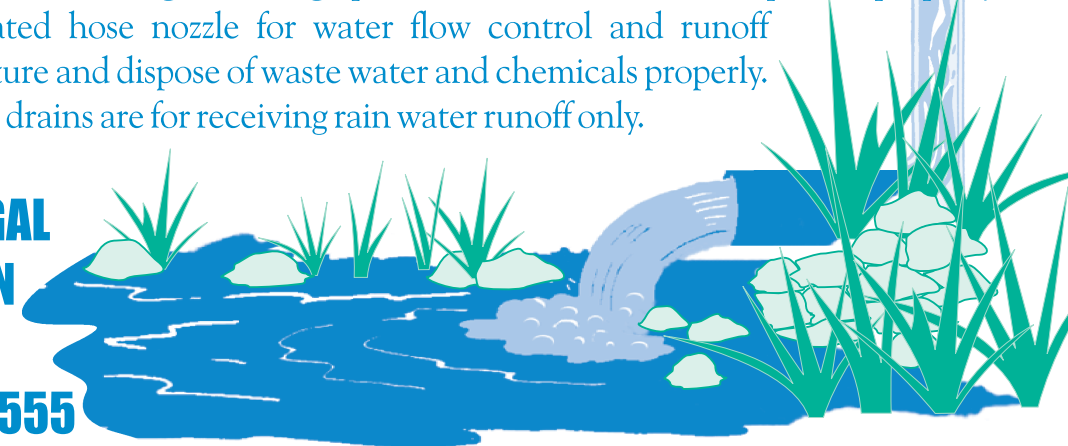

# Help Protect Our Waterways!

Use these guidelines for Outdoor Cleaning Activities and Wash Water Disposal

**D**id you know that disposing of pollutants into the street, gutter, storm drain or body of water is **PROHIBITED** by law and can result in stiff penalties?

## Best Management Practices

Waste wash water from Mechanics, Plumbers, Window/Power Washers, Carpet Cleaners, Car Washing and Mobile Detailing activities may contain significant quantities of motor oil, grease, chemicals, dirt, detergents, brake pad dust, litter and other materials.

Best Management Practices, or BMPs as they are known, are guides to prevent pollutants from entering the storm drains. *Each of us* can do our part to keep stormwater clean by using the suggested BMPs below:

## Simple solutions for both light and heavy duty jobs:

**Do...**consider dry cleaning methods first such as a mop, broom, rag or wire brush. Always keep a spill response kit on site.

**Do...**prepare the work area before power cleaning by using sand bags, rubber mats, vacuum booms, containment pads or temporary berms to keep wash water away from the gutters and storm drains.

**Do...**use vacuums or other machines to remove and collect loose debris or litter before applying water.

**Do...**obtain the property owner's permission to dispose of *small amounts* of power washing waste water on to landscaped, gravel or unpaved surfaces.

**Do...**check your local sanitary sewer agency's policies on wash water disposal regulations before disposing of wash water into the sewer. (See list on reverse side)

**Do...**be aware that if discharging to landscape areas, soapy wash water may damage landscaping. Residual wash water may remain on paved surfaces to evaporate. Sweep up solid residuals and dispose of properly. Vacuum booms are another option for capturing and collecting wash water.

**Do...**check to see if local ordinances prevent certain activities.

**Do not let...**wash or waste water from sidewalk, plaza or building cleaning go into a street or storm drain.



Report illegal storm drain disposal  
Call Toll Free  
**1-800-506-2555**

## Using Cleaning Agents

Try using biodegradable/phosphate-free products. They are easier on the environment, but don't confuse them with being toxic free. Soapy water entering the storm drain system can impact the delicate aquatic environment.



When cleaning surfaces with a *high-pressure washer* or *steam cleaner*, additional precautions should be taken to prevent the discharge of pollutants into the storm drain system. These two methods of surface cleaning can loosen additional material that can contaminate local waterways.

## Think Water Conservation

Minimize water use by using high pressure, low volume nozzles. Be sure to check all hoses for leaks. Water is a precious resource, don't let it flow freely and be sure to shut it off in between uses.

## Screening Wash Water

Conduct thorough dry cleanup before washing exterior surfaces, such as buildings and decks **with loose paint**, sidewalks or plaza areas. Keep debris from entering the storm drain after cleaning by first passing the wash water through a "20 mesh" or finer screen to catch the solid materials, then dispose of the mesh in a refuse container. Do not let the remaining wash water enter a street, gutter or storm drain.

## Drain Inlet Protection & Collection of Wash Water

- Prior to any washing, block all storm drains with an impervious barrier such as sandbags or berms, or seal the storm drain with plugs or other appropriate materials.
- Create a containment area with berms and traps or take advantage of a low spot to keep wash water contained.
- Wash vehicles and equipment on grassy or gravel areas so that the wash water can seep into the ground.
- Pump or vacuum up all wash water in the contained area.

## Concrete/Coring/Saw Cutting and Drilling Projects

Protect any down-gradient inlets by using dry activity techniques whenever possible. If water is used, minimize the amount of water used during the coring/drilling or saw cutting process. Place a barrier of sandbags and/or absorbent berms to protect the storm drain inlet or watercourse. Use a shovel or wet vacuum to remove the residue from the pavement. Do not wash residue or particulate matter into a storm drain inlet or watercourse.



## For Information:

For more information on the General Industrial Storm Water Permit contact:

State Water Resources Control Board (SWRCB)  
(916) 657-1146 or [www.swrcb.ca.gov/](http://www.swrcb.ca.gov/) or, at your  
Regional Water Quality Control Board (RWQCB).

Santa Ana Region (8)  
California Tower  
3737 Main Street, Ste. 500  
Riverside, CA 92501-3339  
(909) 782-4130

San Diego Region (9)  
9771 Clairemont Mesa Blvd., Ste. A  
San Diego, CA 92124  
(619) 467-2952

Colorado River Basin Region (7)  
73-720 Fred Waring Dr., Ste. 100  
Palm Desert, CA 92260  
(760) 346-7491

### SPILL RESPONSE AGENCY:

HAZ-MAT: (909) 358-5055  
HAZARDOUS WASTE DISPOSAL: (909) 358-5055  
RECYCLING INFORMATION: 1-800-366-SAVE  
TO REPORT ILLEGAL DUMPING OR A CLOGGED  
STORM DRAIN: 1-800-506-2555

To order additional brochures or to obtain information  
on other pollution prevention activities, call:  
(909) 955-1111.



Riverside County gratefully acknowledges the State Water Quality Control Board and the American Public Works Association, Storm Water Quality Task Force for the information provided in this brochure.

## DID YOU KNOW . . .

### ***YOUR FACILITY MAY NEED A STORM WATER PERMIT?***



*Many industrial facilities  
and manufacturing operations  
must obtain coverage under the  
Industrial Activities Storm Water  
General Permit*

***FIND OUT  
IF YOUR FACILITY  
MUST OBTAIN A PERMIT***

## ***StormWater Pollution . . . What you should know***

Riverside County has two drainage systems - sanitary sewers and storm drains. The storm drain system is designed to help prevent flooding by carrying excess rainwater away from streets. Since the storm drain system does not provide for water treatment, it also serves the *unintended* function of transporting pollutants directly to our waterways.

*Unlike sanitary sewers, storm drains are not connected to a treatment plant - they flow directly to our local streams, rivers and lakes.*

In recent years, awareness of the need to protect water quality has increased. As a result, federal, state, and local programs have been established to reduce polluted stormwater discharges to our waterways. The emphasis of these programs is to prevent stormwater pollution since it's much easier, and less costly, than cleaning up "after the fact."



## ***National Pollutant Discharge Elimination System (NPDES)***

In 1987, the Federal Clean Water Act was amended to establish a framework for regulating industrial stormwater discharges under the NPDES permit program. In California, NPDES permits are issued by the State Water Resources Control Board (SWRCB) and the nine (9) Regional Water Quality Control Boards (RWQCB). In general, certain industrial facilities and manufacturing operations must obtain coverage under the Industrial Activities Storm Water General Permit if the type of facilities or operations falls into one of the several categories described in this brochure.

## How Do I Know If I Need A Permit?

Following are **general descriptions** of the industry categories types that are regulated by the Industrial Activities Storm Water General Permit. Contact your local Region Water Quality Control Board to determine if your facility/operation requires coverage under the Permit.

→ Facilities such as cement manufacturing; feedlots; fertilizer manufacturing; petroleum refining; phosphate manufacturing; steam electric power generation; coal mining; mineral mining and processing; ore mining and dressing; and asphalt emulsion;

→ Facilities classified as lumber and wood products (except wood kitchen cabinets); pulp, paper, and paperboard mills; chemical producers (except some pharmaceutical and biological products); petroleum and coal products; leather production and products; stone, clay and glass products; primary metal industries; fabricated structural metal; ship and boat building and repairing;

→ Active or inactive mining operations and oil and gas exploration, production, processing, or treatment operations;

→ Hazardous waste treatment, storage, or disposal facilities;

→ Landfills, land application sites and open dumps that receive or have received any industrial waste; unless there is a new overlying land use such as a golf course, park, etc., and there is no discharge associated with the landfill;

→ Facilities involved in the recycling of materials, including metal scrap yards, battery reclaimers, salvage yards, and automobile junkyards;

→ Steam electric power generating facilities, facilities that generate steam for electric power by combustion;

→ Transportation facilities that have vehicle maintenance shops, fueling facilities, equipment cleaning operations, or airport deicing operations. This includes school bus maintenance facilities operated by a school district;

→ Sewage treatment facilities;

→ Facilities that have areas where material handling equipment or activities, raw materials, intermediate products, final products, waste materials, by-products, or industrial machinery are exposed to storm water.

## How do I obtain coverage under the Industrial Activities Storm Water General Permit?

Obtain a permit application package from your local Regional Water Quality Control Board listed on the back of this brochure or the State Water Resources Control Board (SWRCB). Submit a completed Notice of Intent (NOI) form, site map and the appropriate fee (\$250 or \$500) to the SWRCB. Facilities must submit an NOI thirty (30) days prior to beginning operation. Once you submit the NOI, the State Board will send you a letter acknowledging receipt of your NOI and will assign your facility a waste discharge identification number (WDID No.). You will also receive an annual fee billing. These billings should roughly coincide with the date the State Board processed your original NOI submittal.

## What are the requirements of the Industrial Activities Storm Water General Permit?

The basic requirements of the Permit are:

1. The facility must eliminate any non-stormwater discharges or obtain a separate permit for such discharges.
2. The facility must develop and implement a Storm Water Pollution Prevention Plan (SWPPP). The SWPPP must identify sources of pollutants that may be exposed to stormwater. Once the sources of pollutants have been identified, the facility operator must develop and implement Best Management Practices (BMPs) to minimize or prevent polluted runoff.

*Guidance in preparing a SWPPP is available from a document prepared by the California Storm Water Quality Task Force called the California Storm Water Best Management Practice Handbook.*

3. The facility must develop and implement a Monitoring Program that includes conducting visual observations and collecting samples of the facility's storm water discharges associated with industrial activity. The General Permit requires that the analysis be conducted by a laboratory that is certified by the State of California.
4. The facility must submit to the Regional Board, every July 1, an annual report that includes the results of its monitoring program.

**A Non-Storm Water Discharge is...** any discharge to a storm drain system that is not composed entirely of storm water. The following non-storm water discharges are authorized by the General Permit: fire hydrant flushing; potable water sources, including potable water related to the operation, maintenance, or testing of potable water systems; drinking fountain water; atmospheric condensates including refrigeration, air conditioning, and compressor condensate; irrigation drainage; landscape watering; springs; non-contaminated ground water; foundation or footing drainage; and sea water infiltration where the sea waters are discharged back into the sea water source.

**A BMP is . . .** a technique, process, activity, or structure used to reduce the pollutant content of a storm water discharge. BMPs may include simple, non-structural methods such as good housekeeping, staff training and preventive maintenance. Additionally, BMPs may include structural modifications such as the installation of berms, canopies or treatment control (e.g. setting basins, oil/water separators, etc.)



**WARNING:** There are significant penalties for non-compliance: a minimum fine of \$5,000 for failing to obtain permit coverage, and, up to \$10,000 per day, per violation plus \$10 per gallon of discharge in excess of 1,000 gallons.